

SPLIT

Typ R

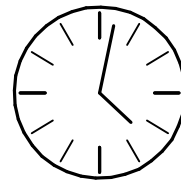

40 min

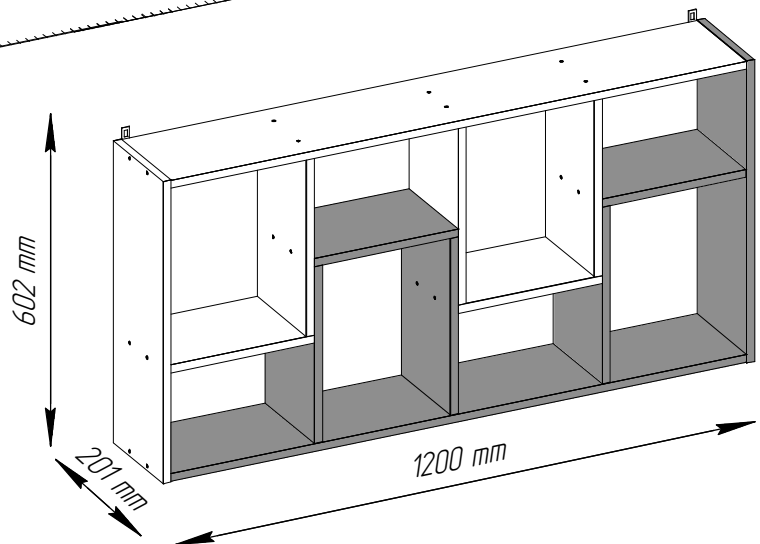
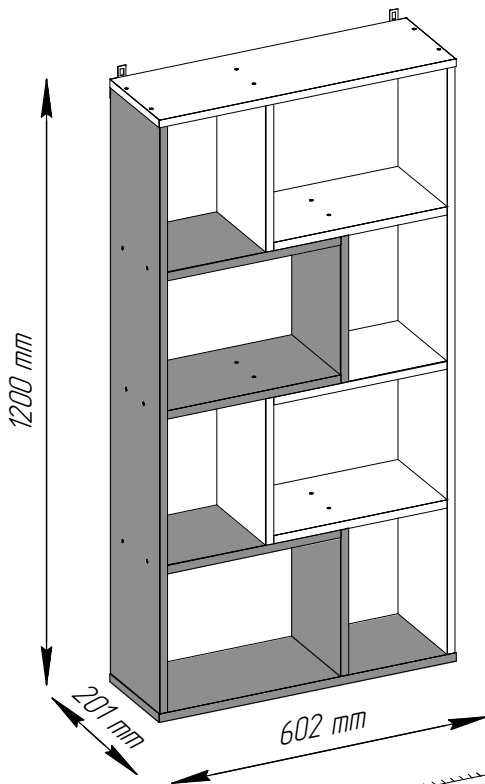
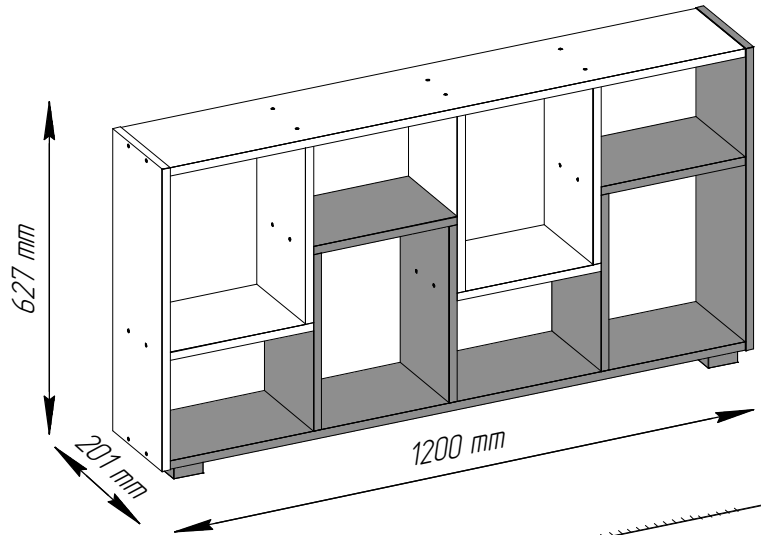
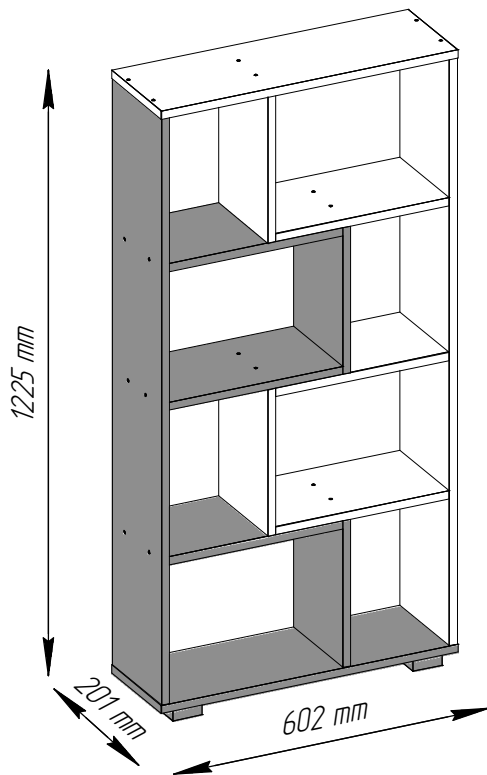
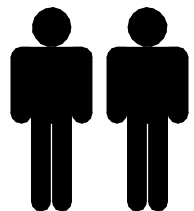

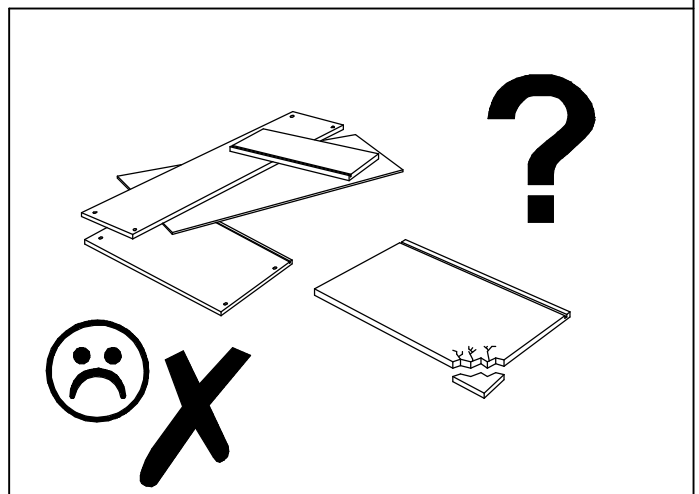
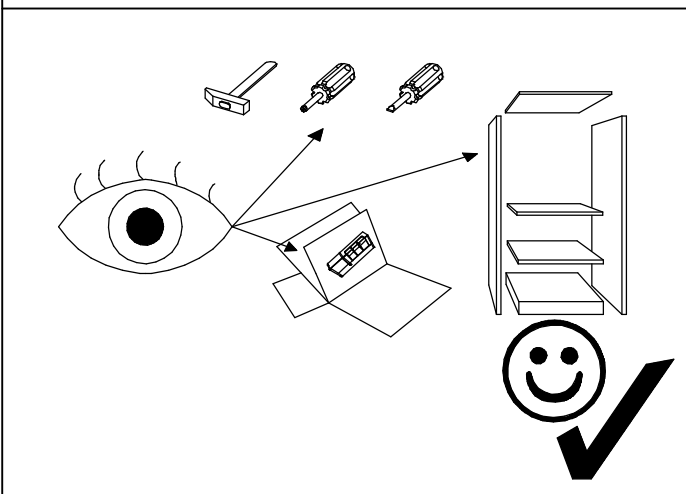
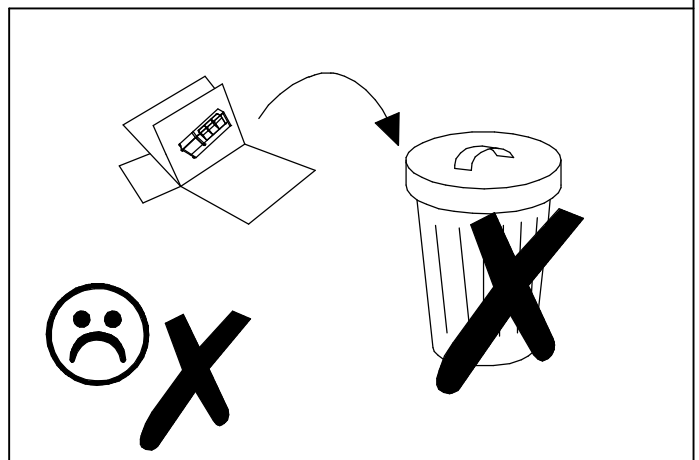
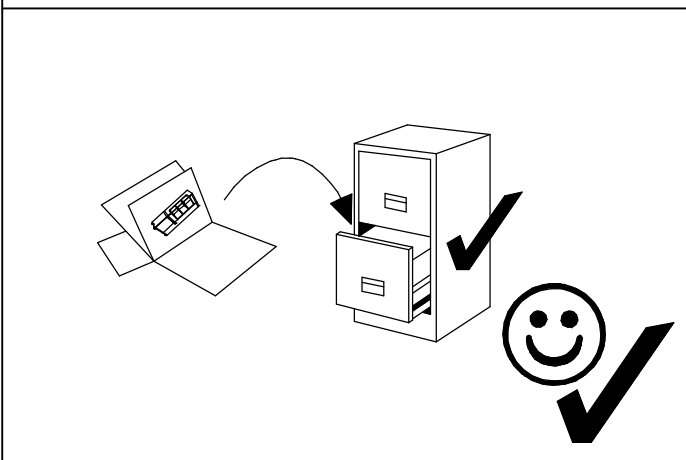
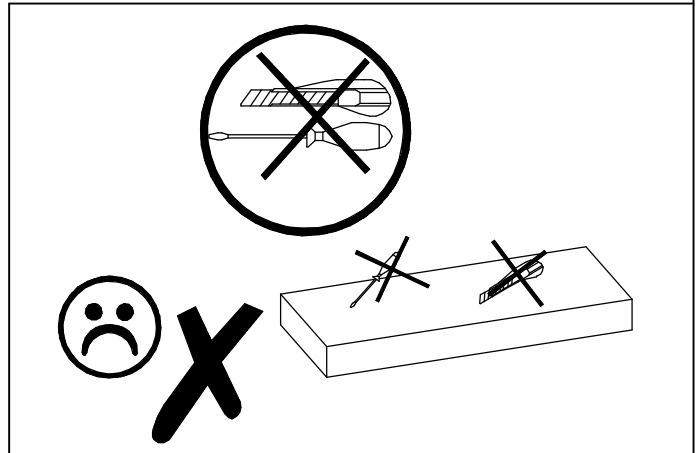
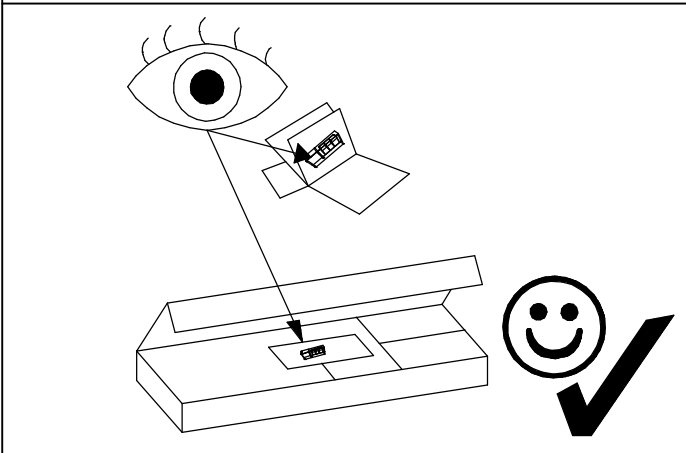

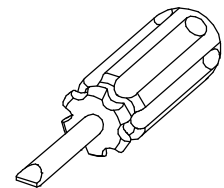
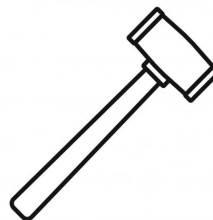
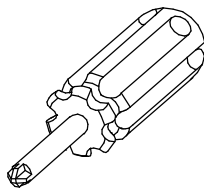
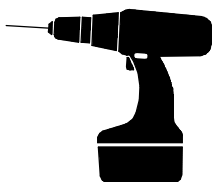
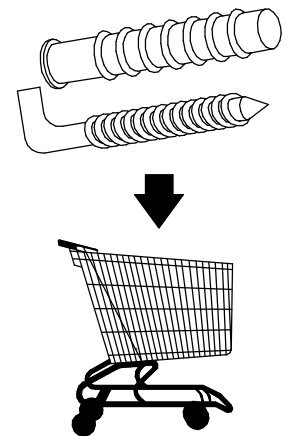
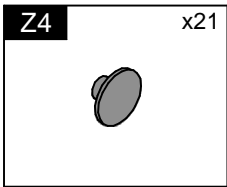
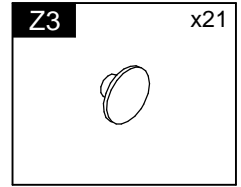
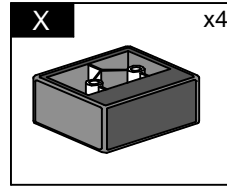
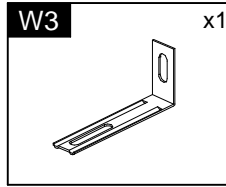
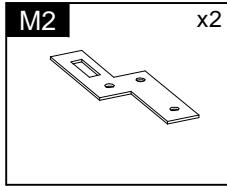
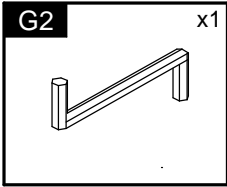
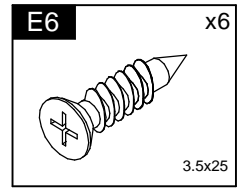
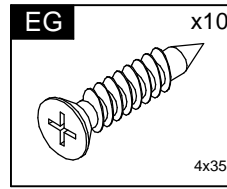
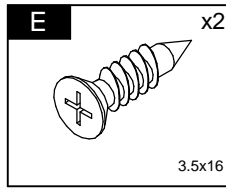
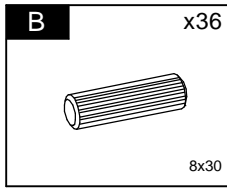
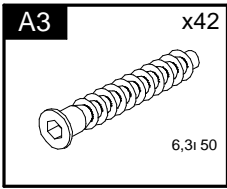
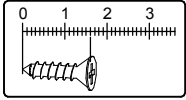
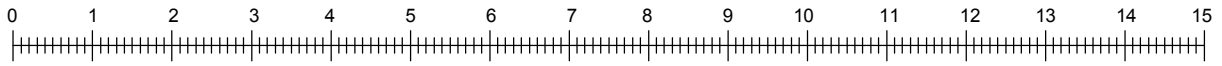

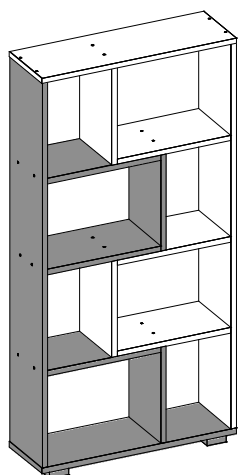

Element symbol	Measurements				Code	Paket
	1	2	3	4		
1	1168	200	16	1	1003	1/1
2	602	201	16	1	1004	1/1
3	292	199	16	1	1010	1/1
4	352	199	16	2	1007	1/1
5	352	199	16	1	1011	1/1
6	292	199	16	1	1013	1/1
7	352	199	16	2	1014	1/1
8	1168	200	16	1	1002	1/1
9	352	199	16	1	1009	1/1
10	602	201	16	1	1005	1/1
11	292	199	16	1	1006	1/1
12	292	199	16	1	1008	1/1

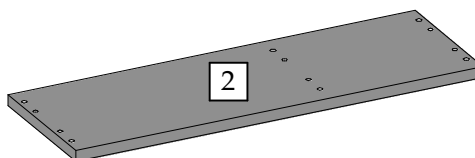
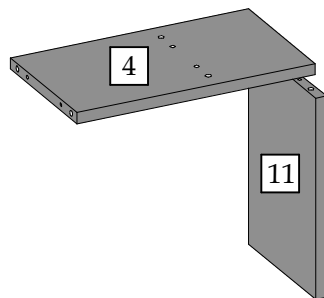
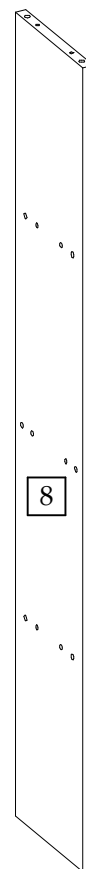
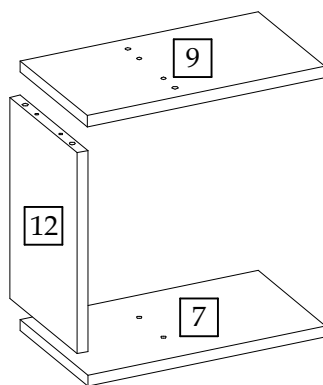
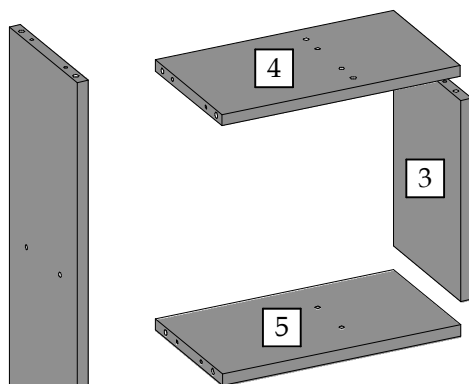
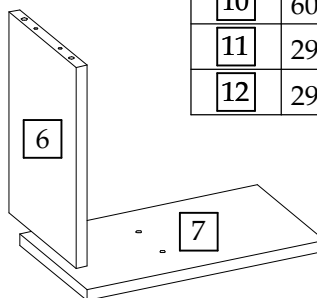
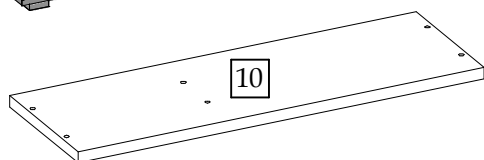

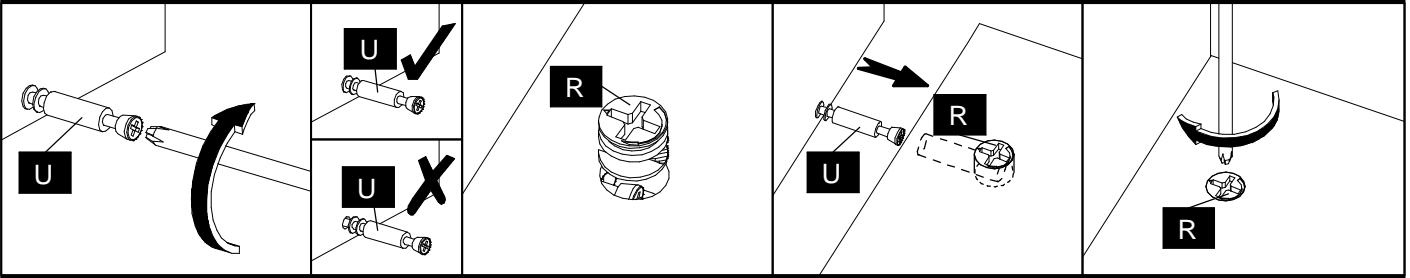

1

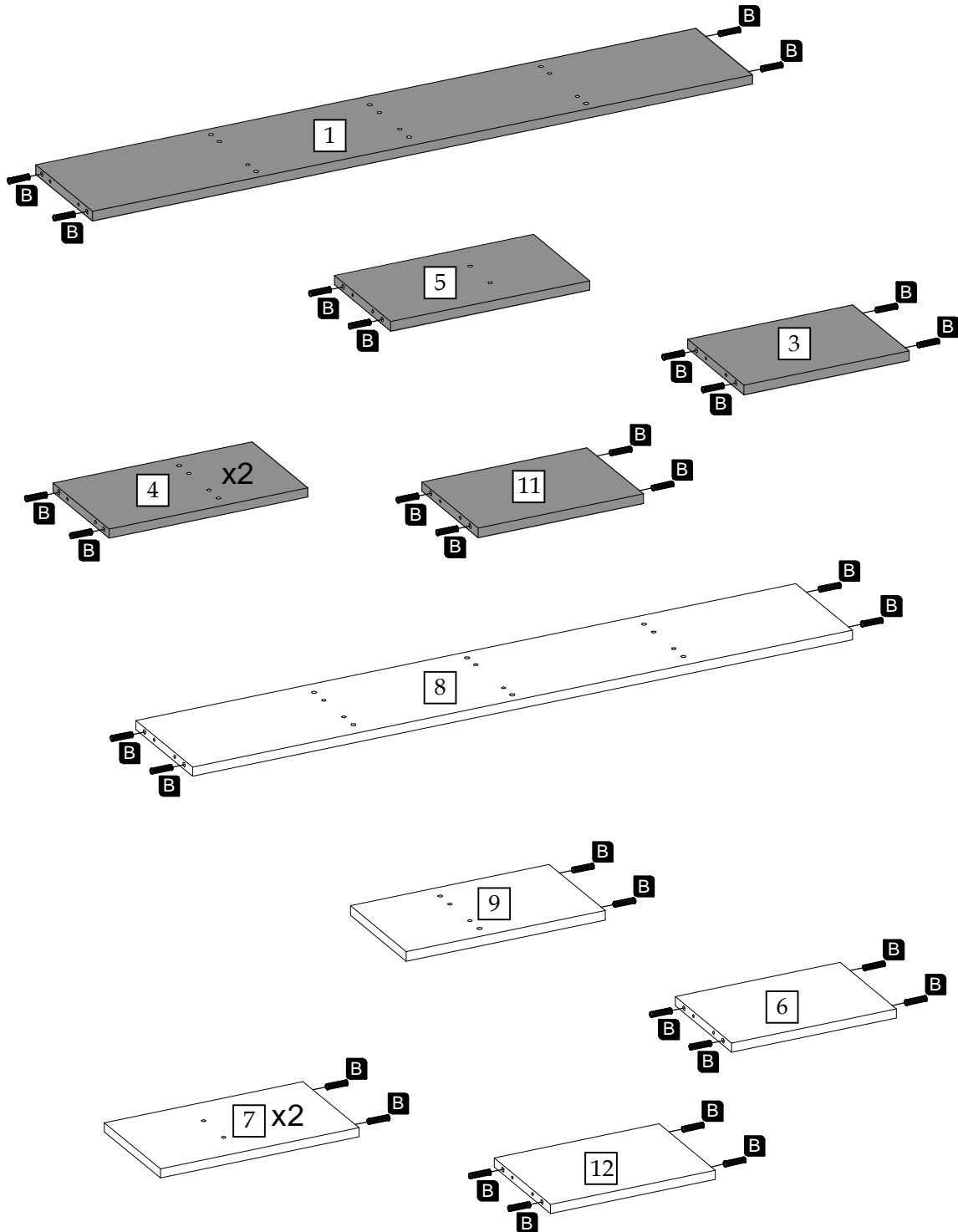

2

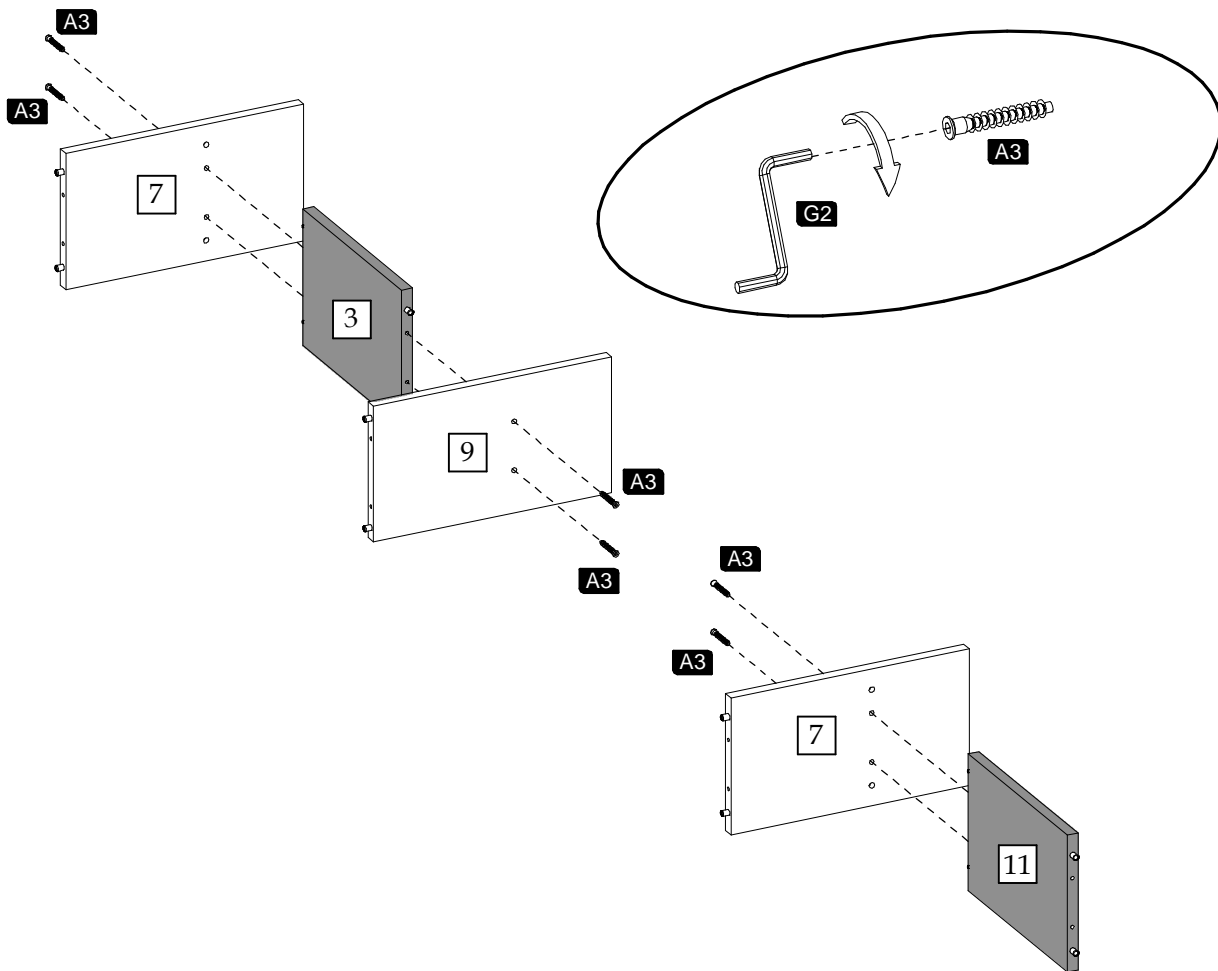

3

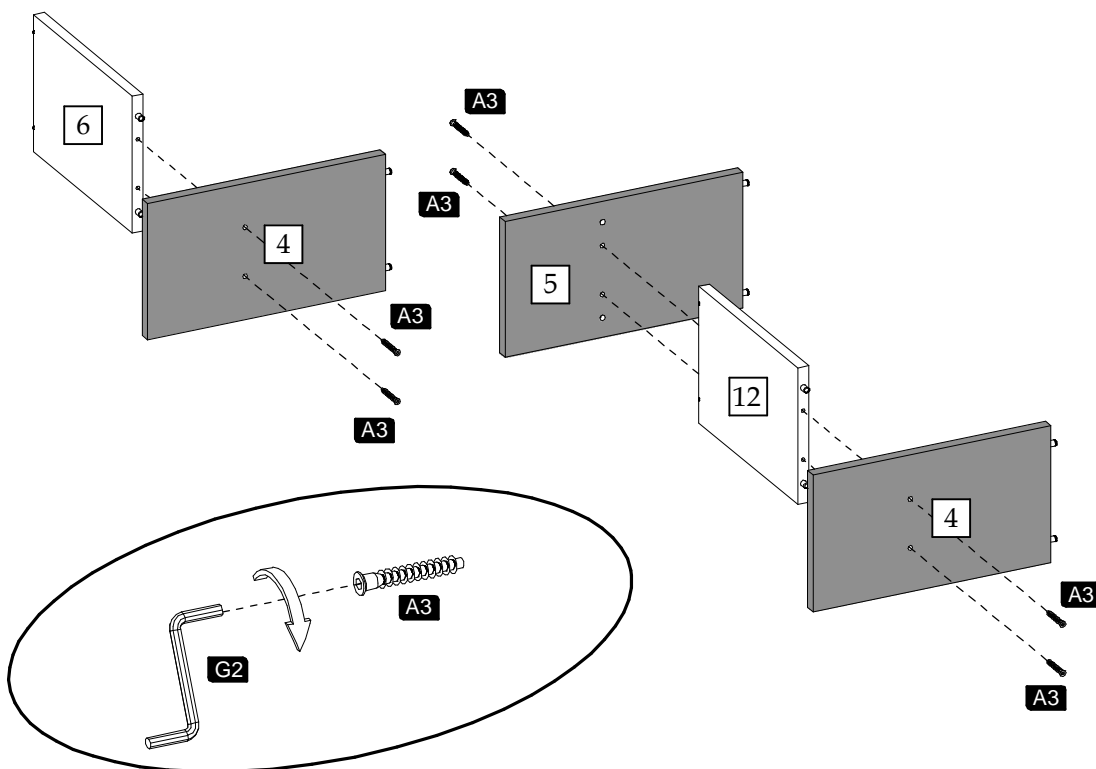

4

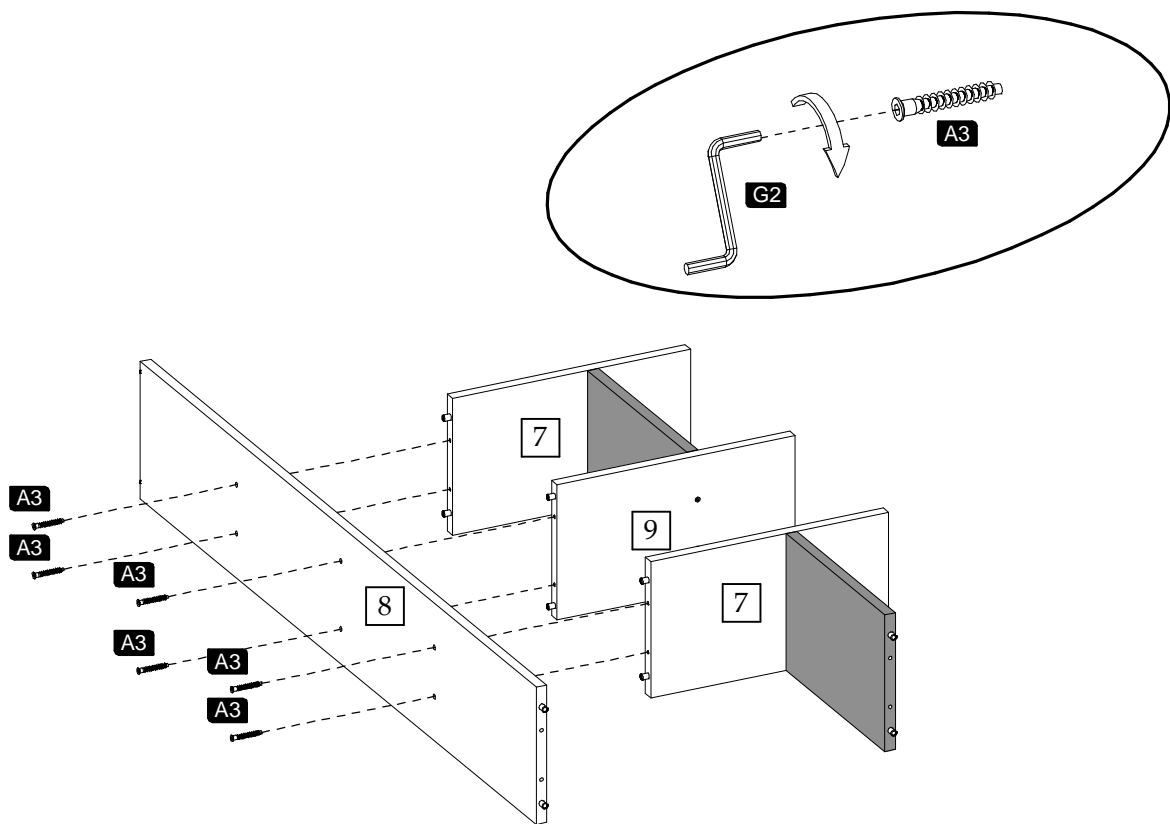

5

