

SUDBURY

Typ F

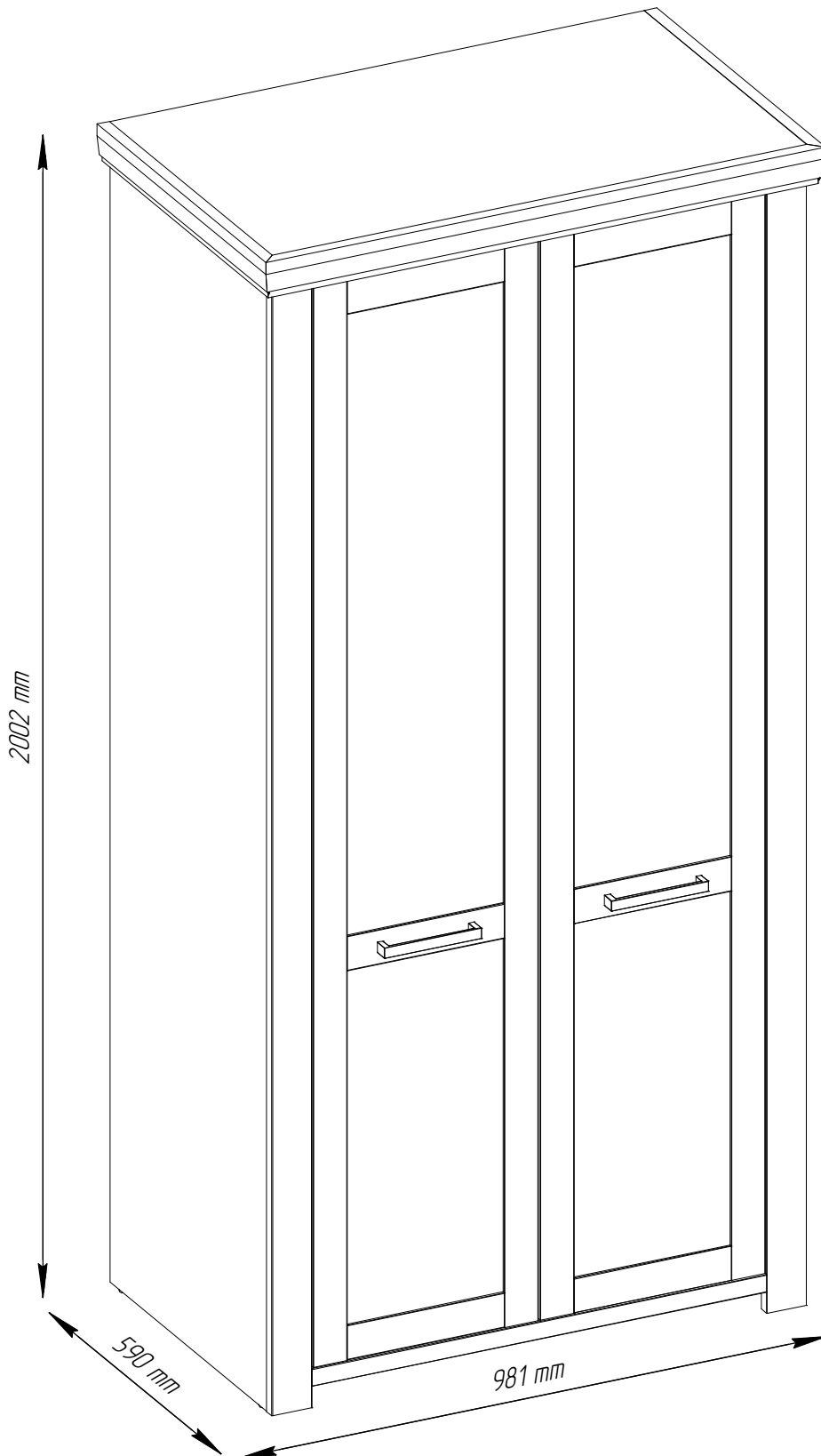

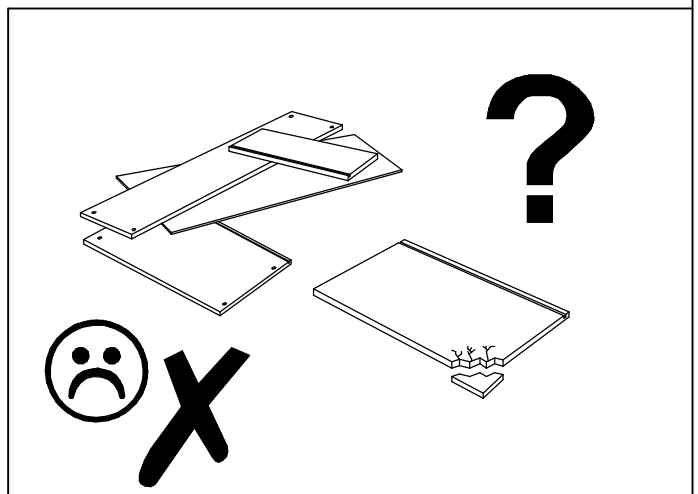

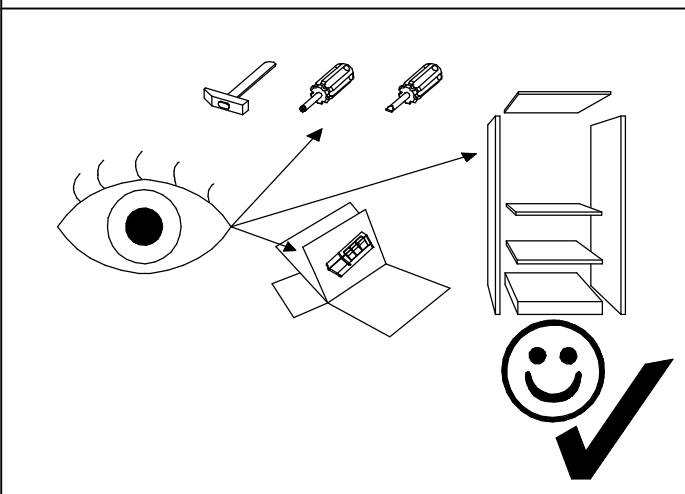
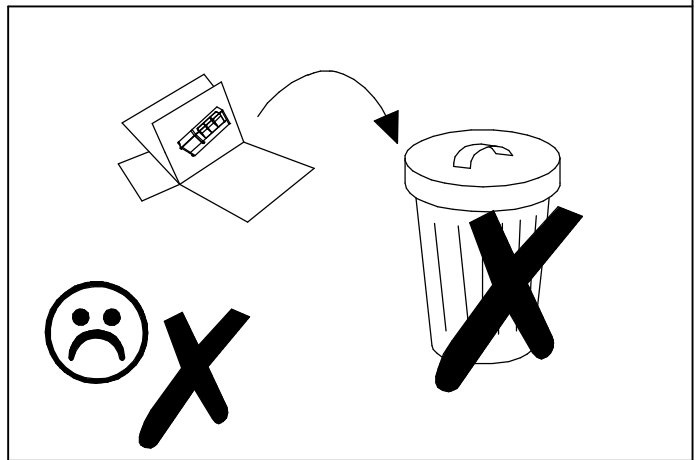
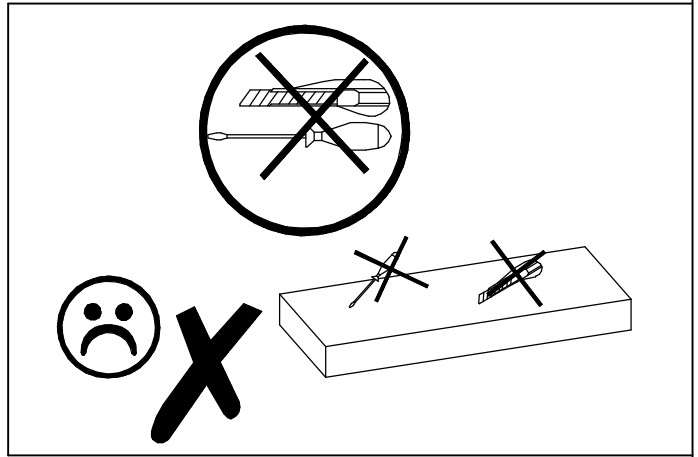
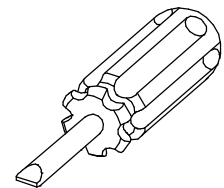
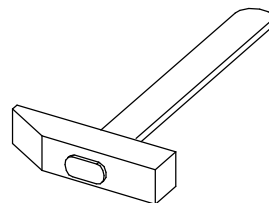
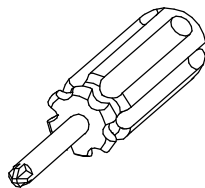
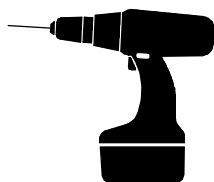
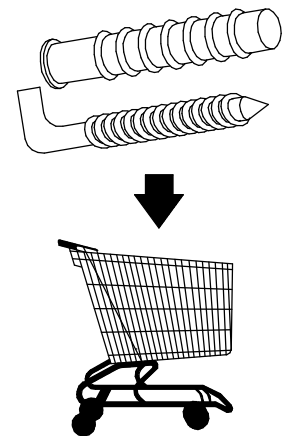
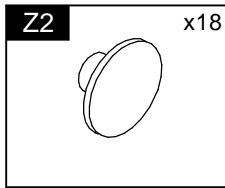
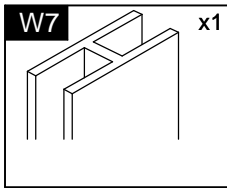
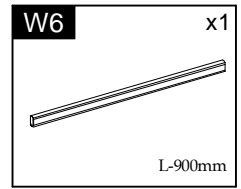
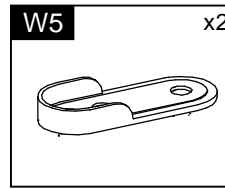
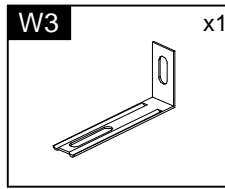
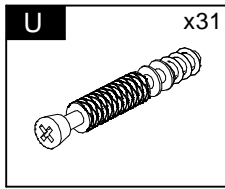
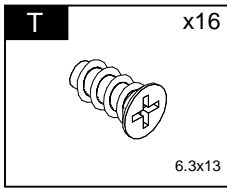
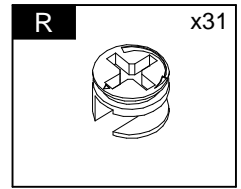
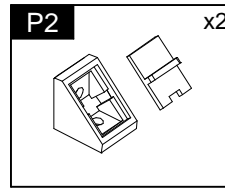
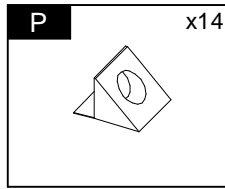
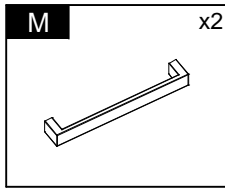
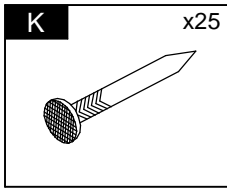
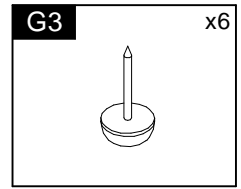
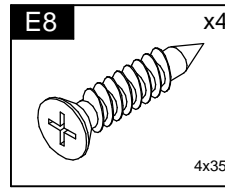
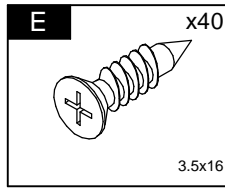
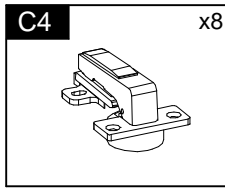
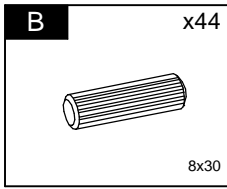
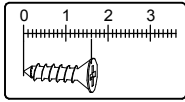

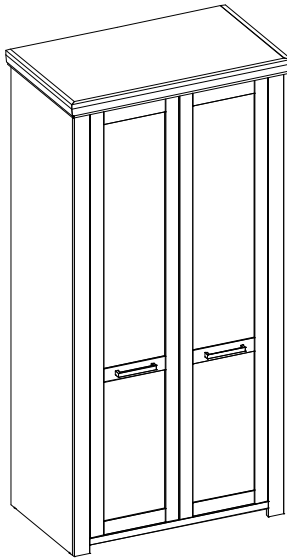

Element symbol	Measurements				Code	Paket
1	981	590	65	1	1003	3/3
2	1980.5	548.5	16	1	1001	1/3
3	1980.5	548.5	16	1	1004	1/3
4	904	528.5	16	1	1005	1/3
5	904	50	16	1	1007	1/3
6	904	528.5	16	2	1008	1/3
7	904	90	16	1	1071	1/3
8	1937	458	3	2	N/A	1/3
9	1980	70	19	1	3019	1/3
10	1980	70	19	1	3020	1/3
11	797	30	19	1	3021	1/3
12	1859	395	19	1	3017	2/3
13	1859	395	19	1	3018	2/3

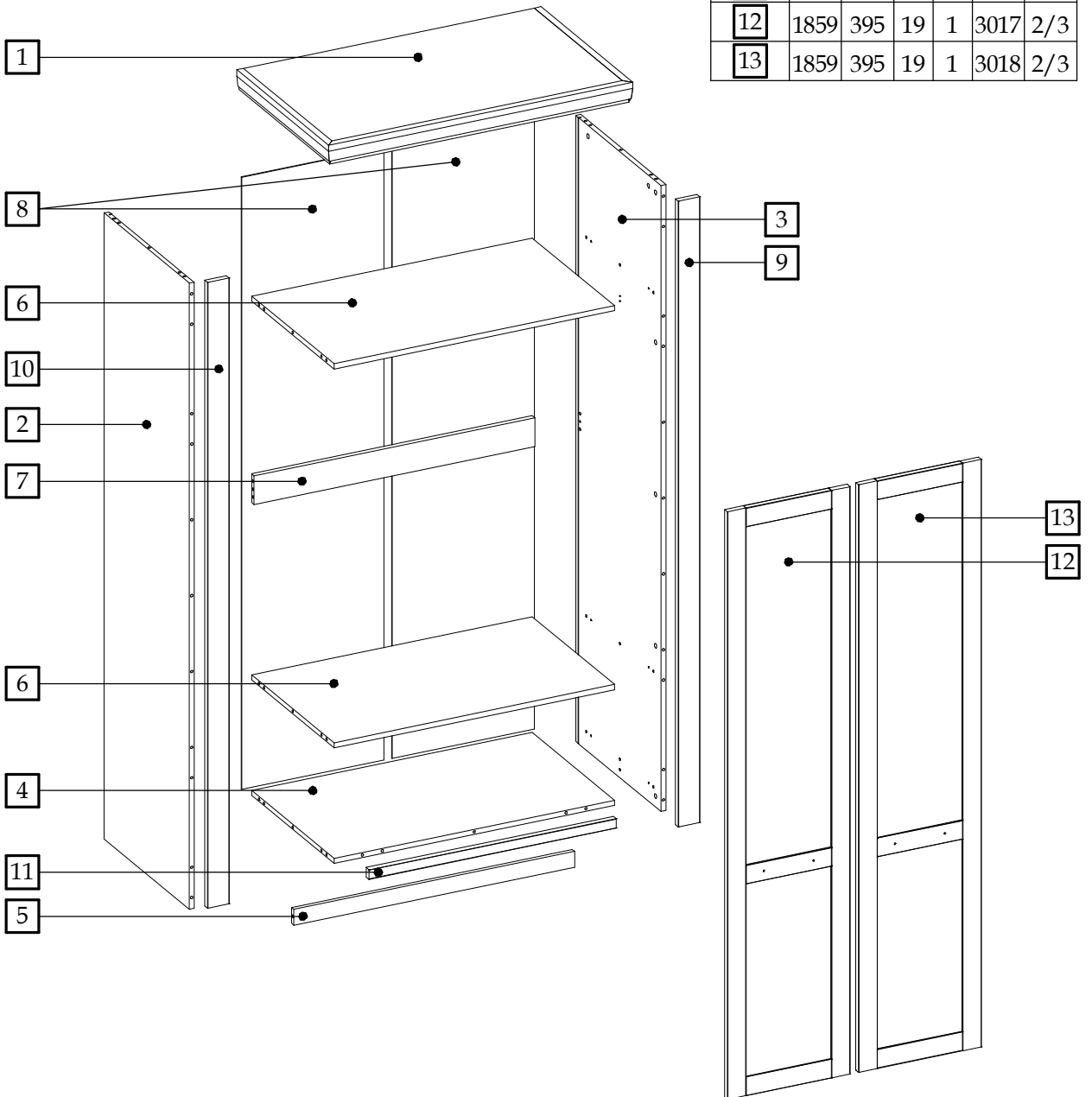

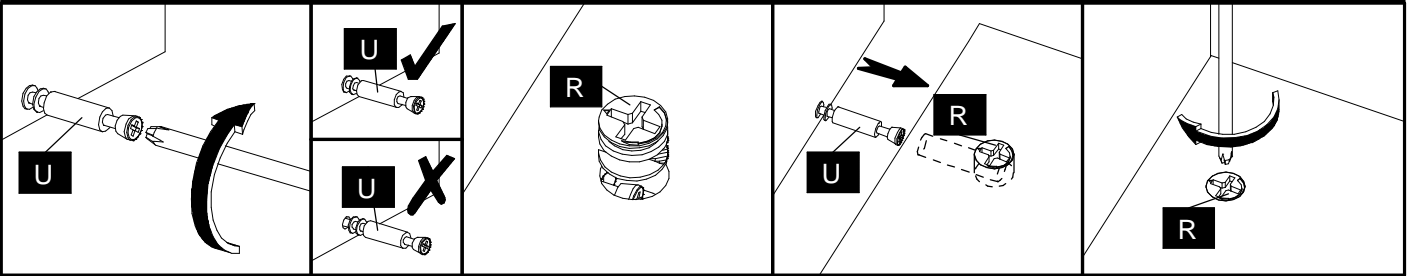

1

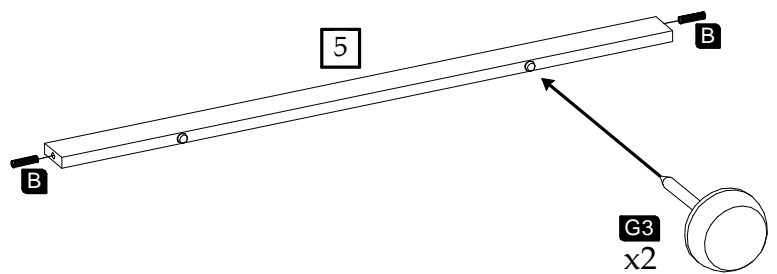
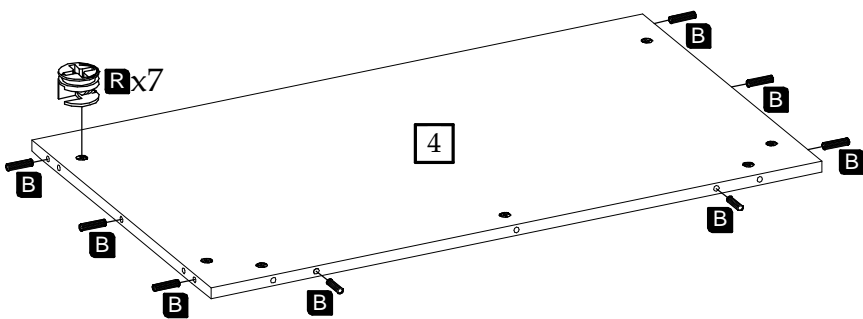
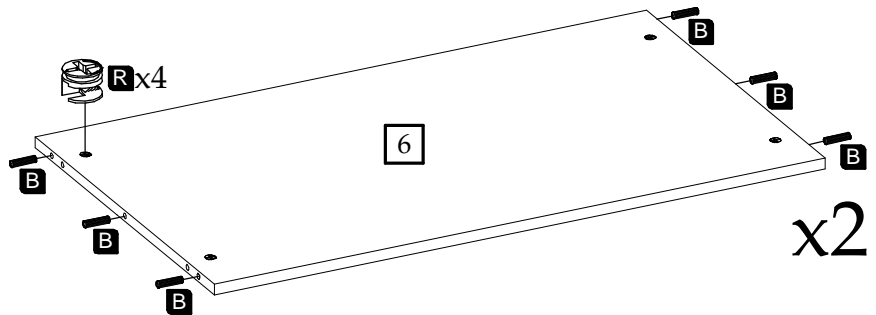
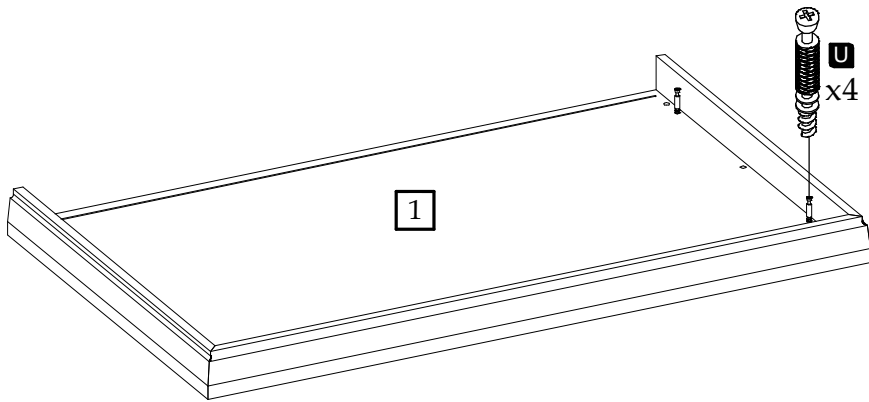

2

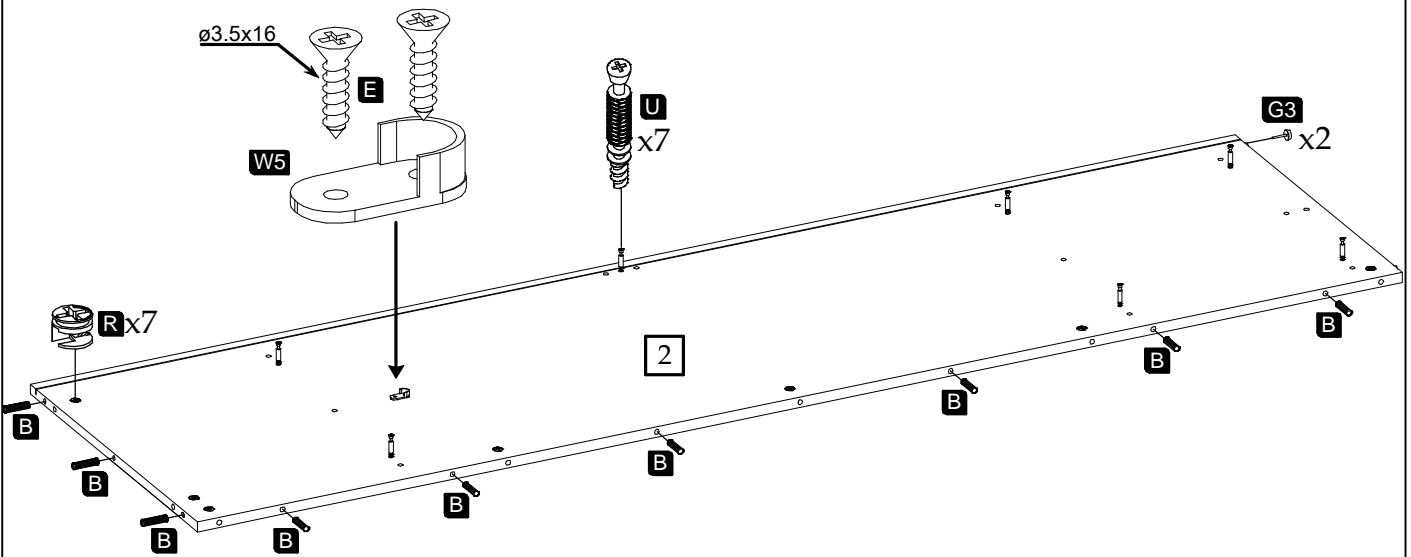

3

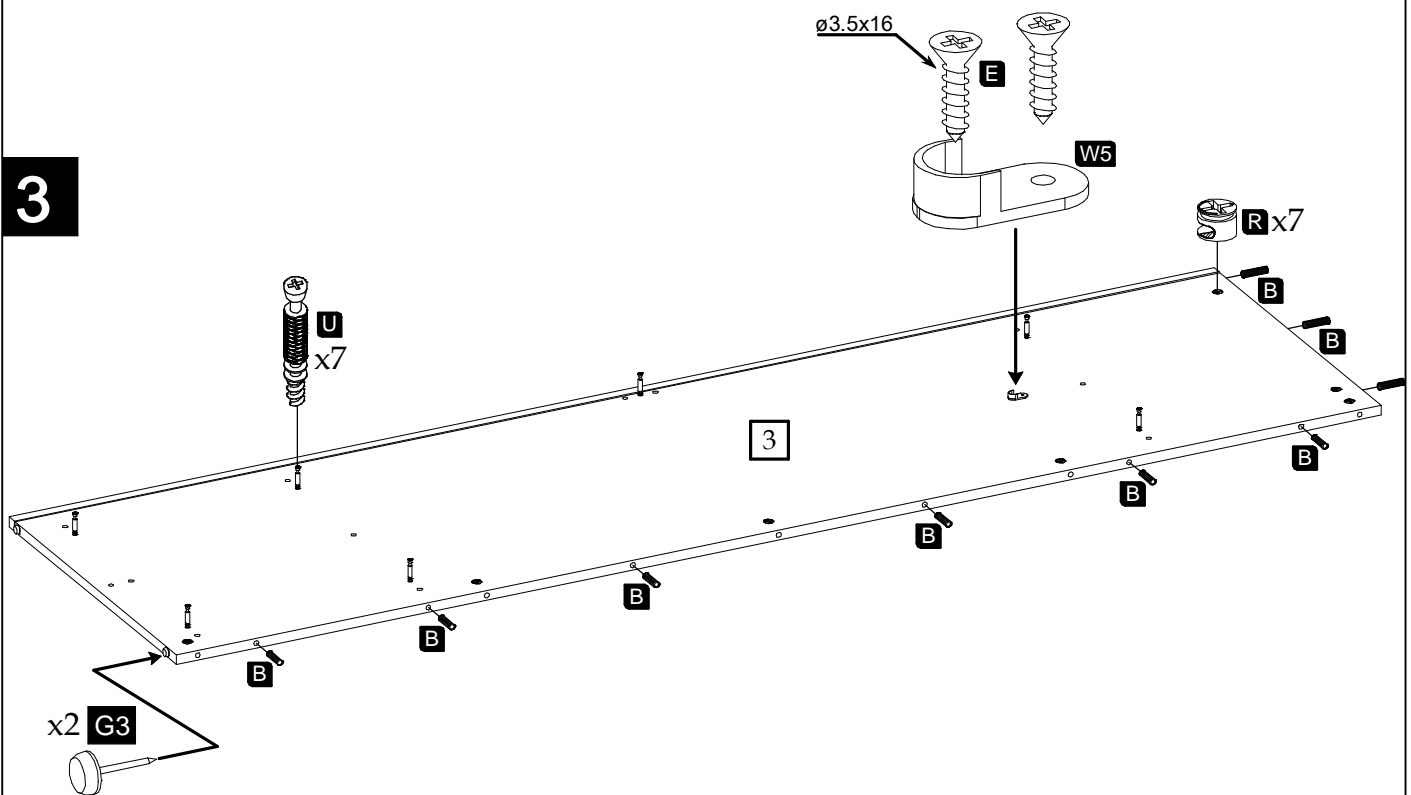

7

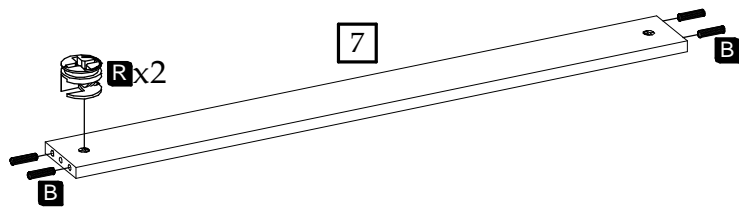

4

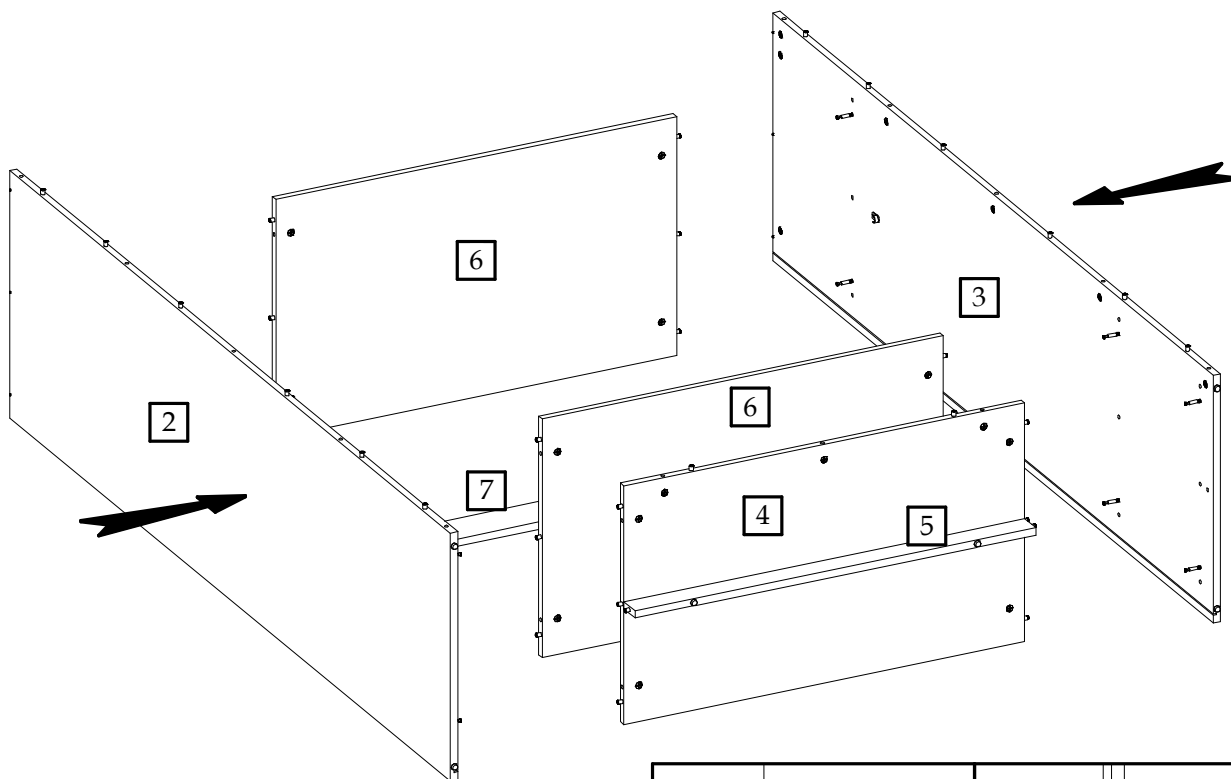

5

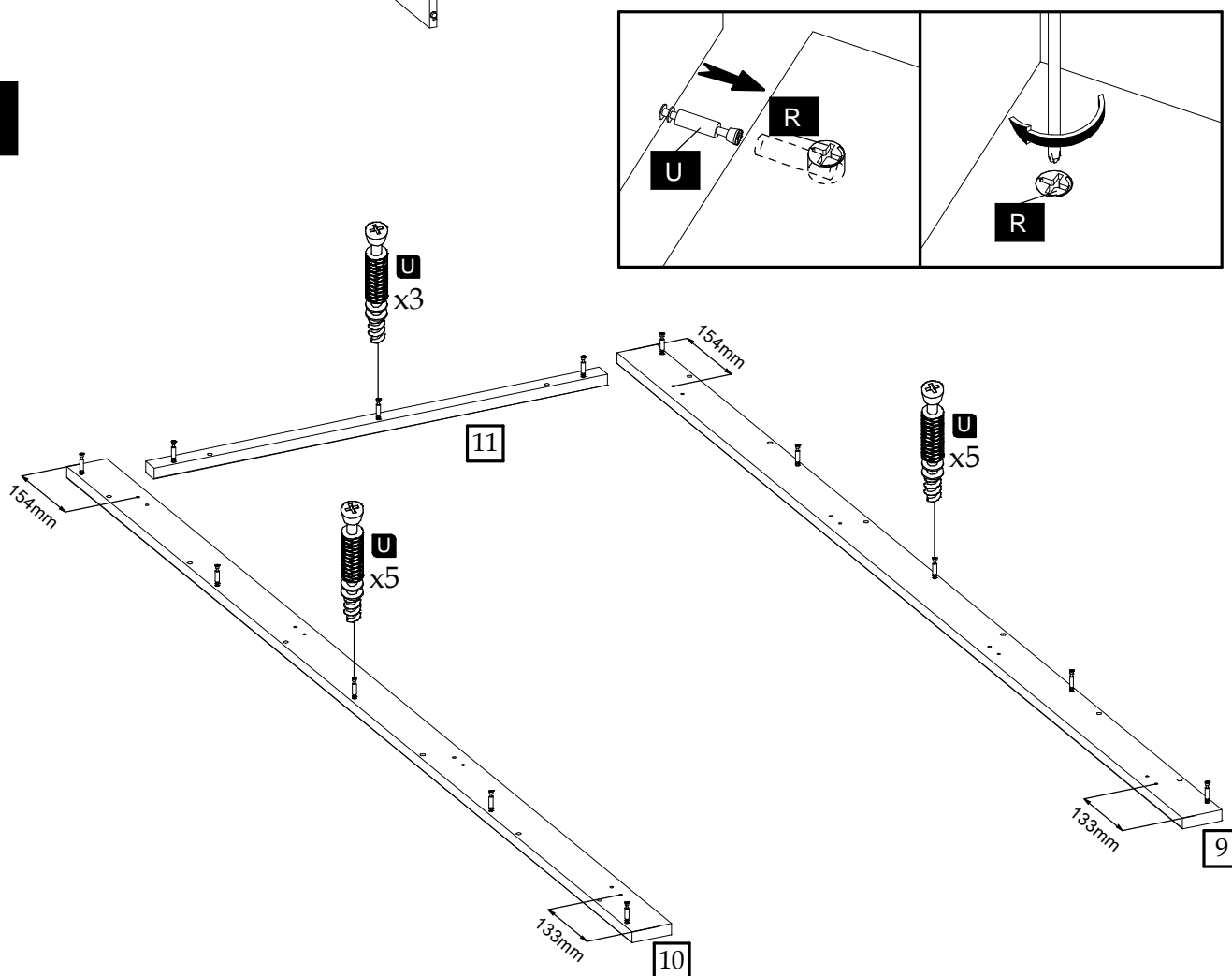

6

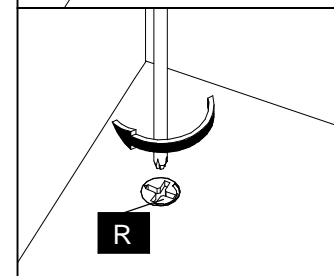
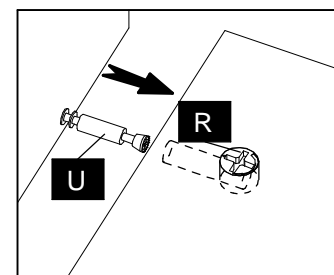
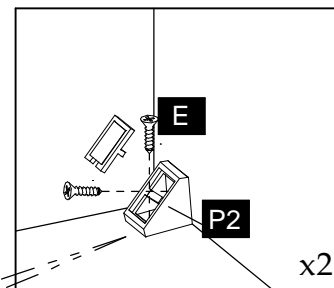
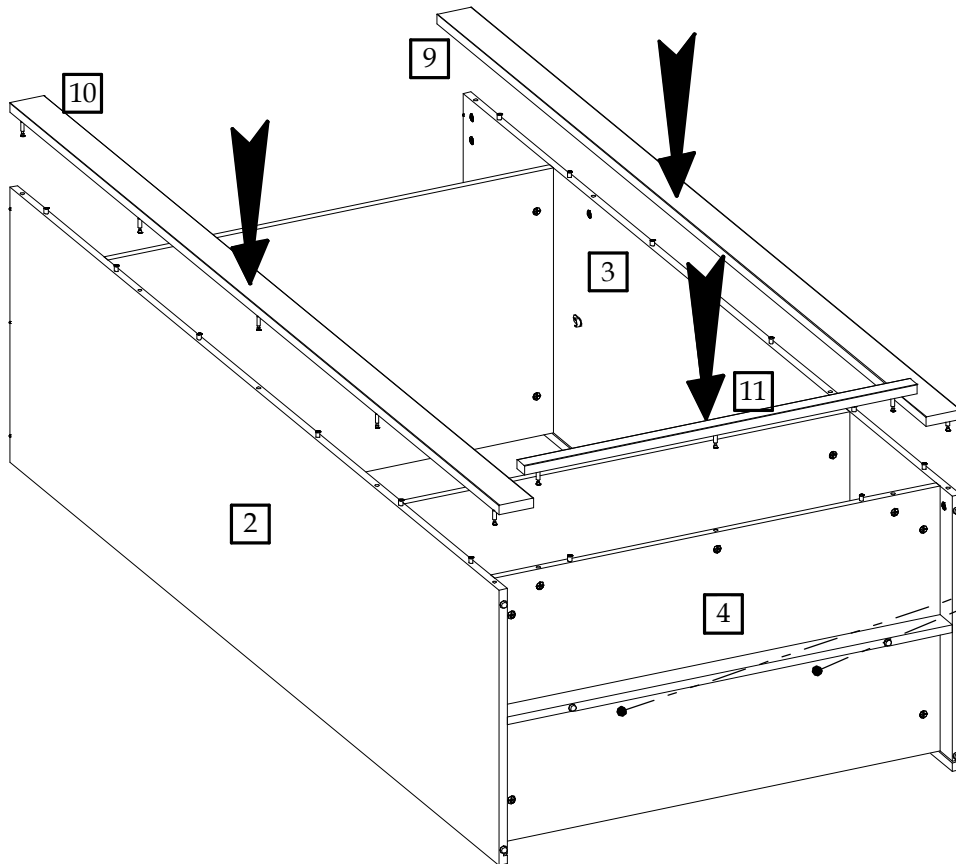

7

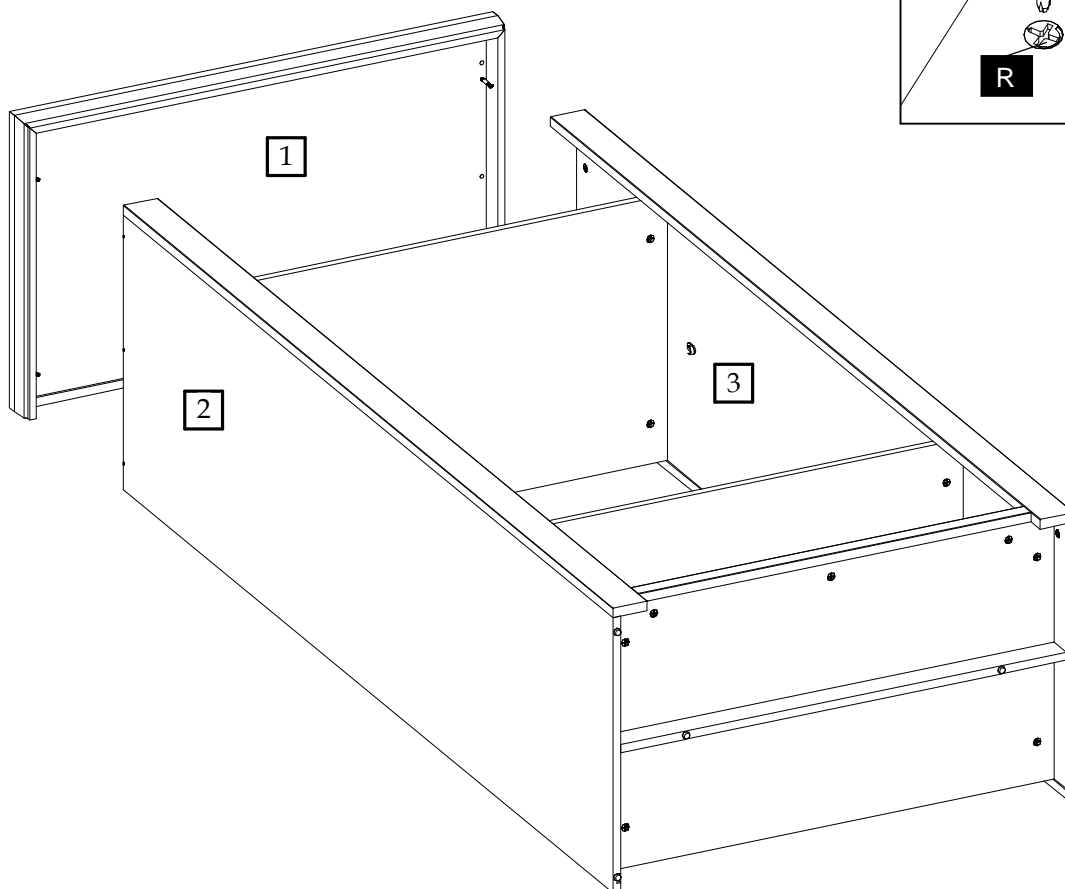

8

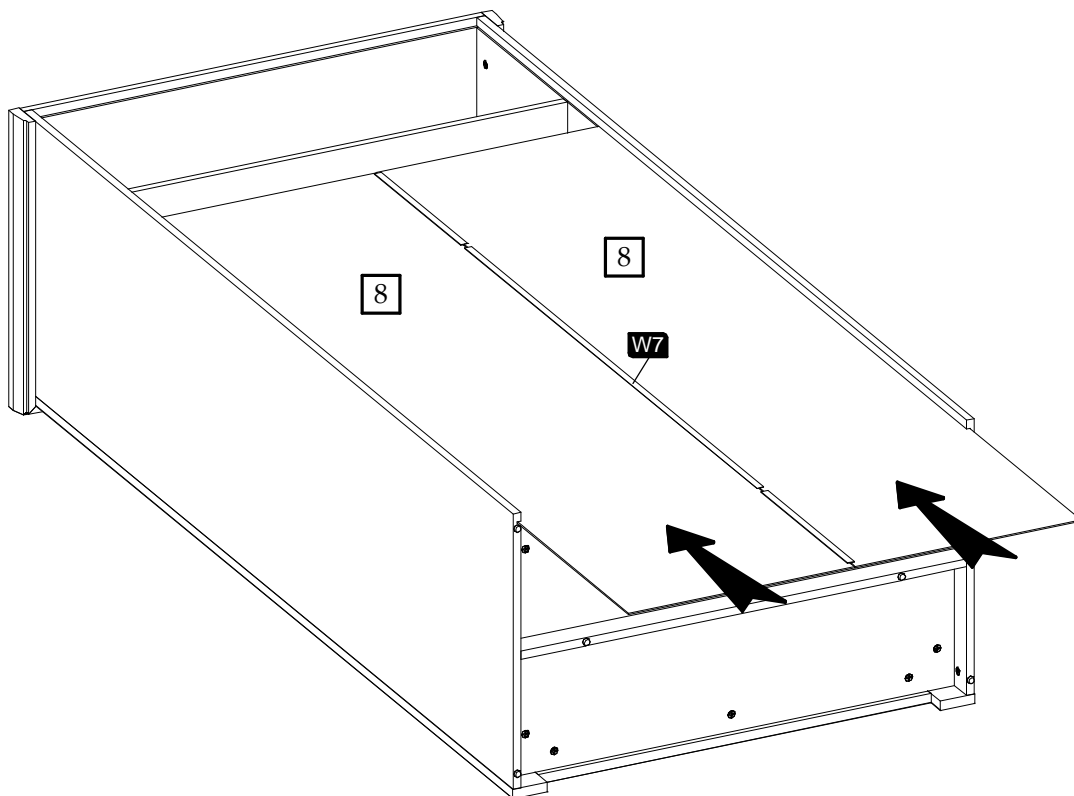

9

