

# THOME SPLIT G

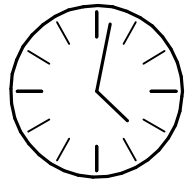

30 min

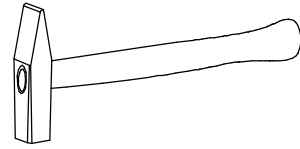

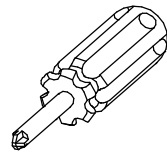
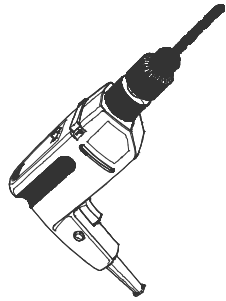
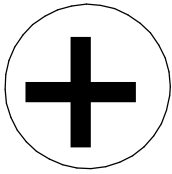
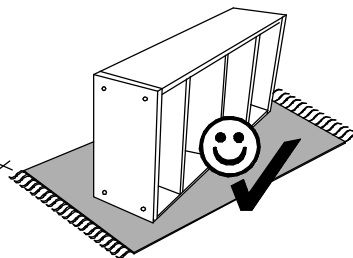
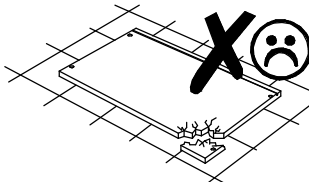
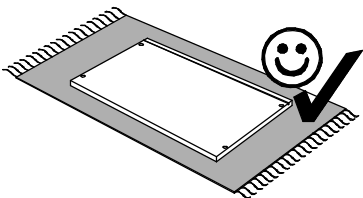
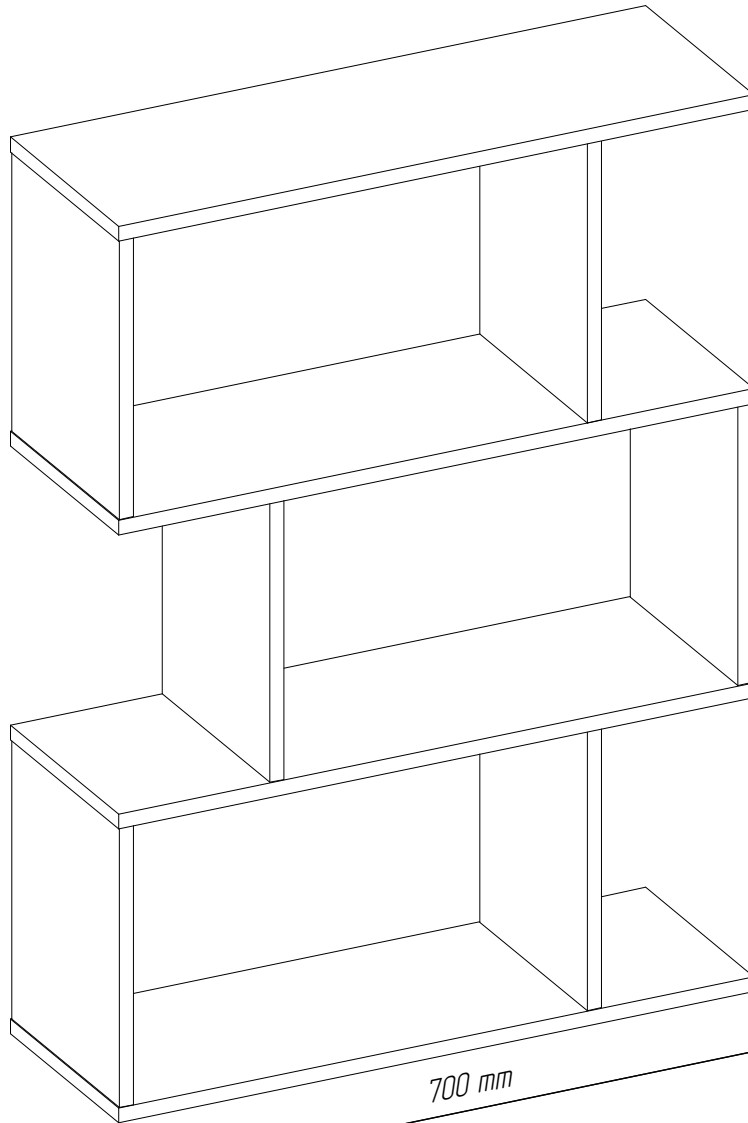
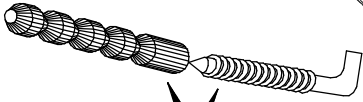
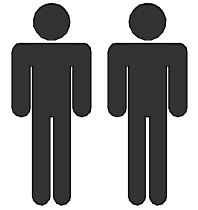
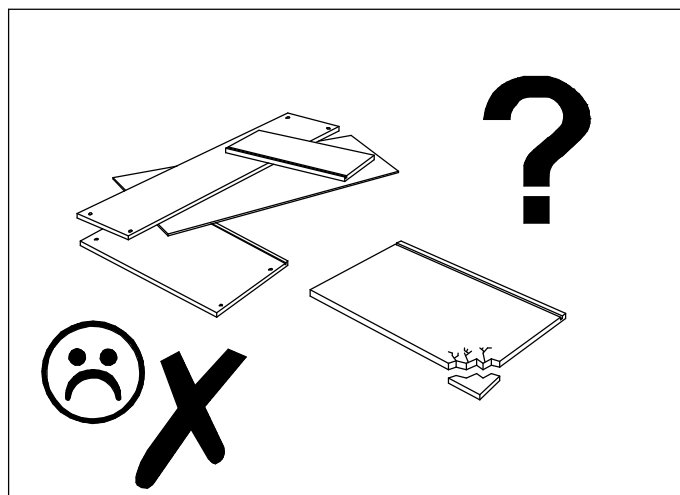
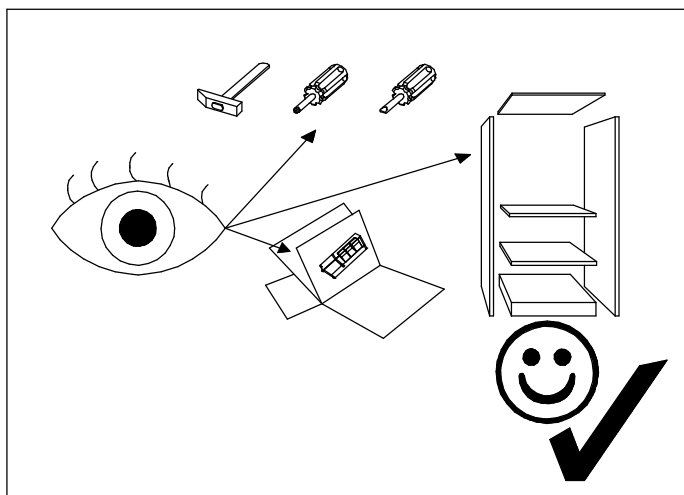
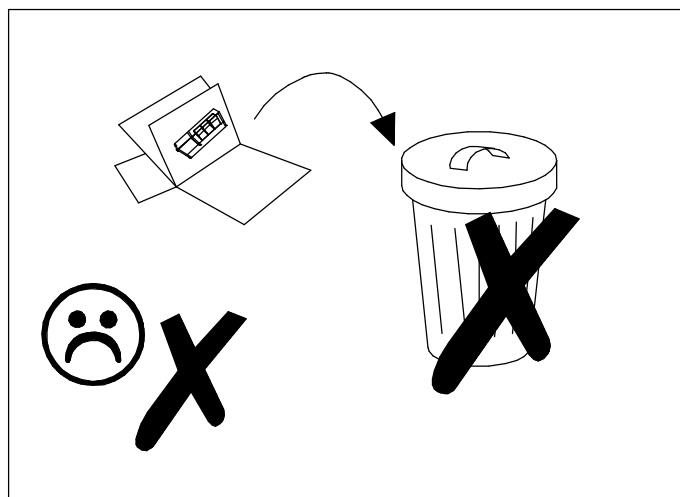
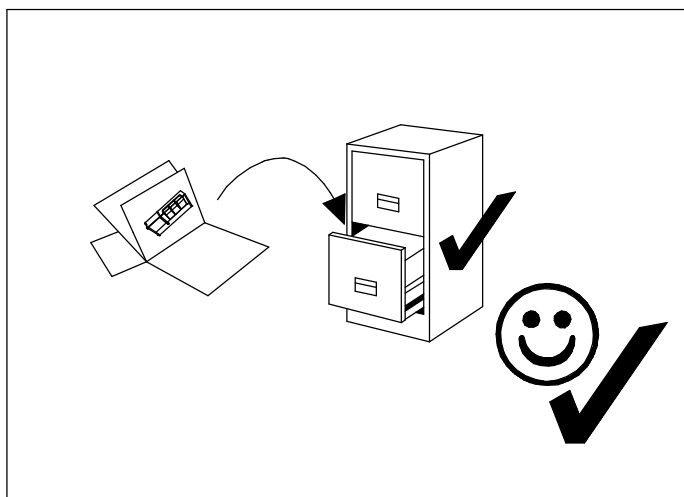
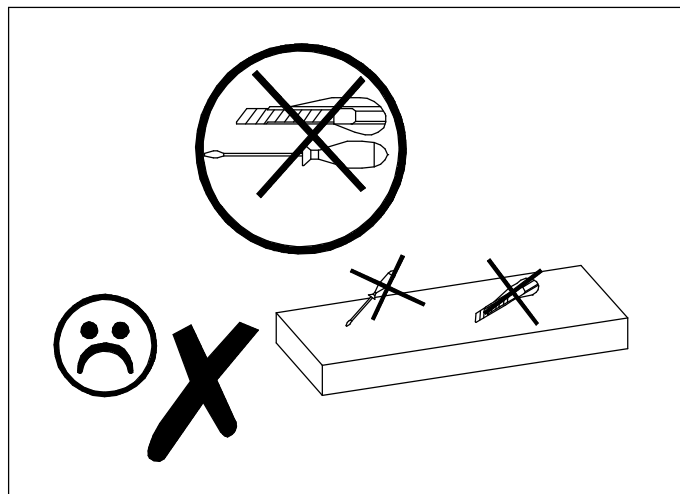

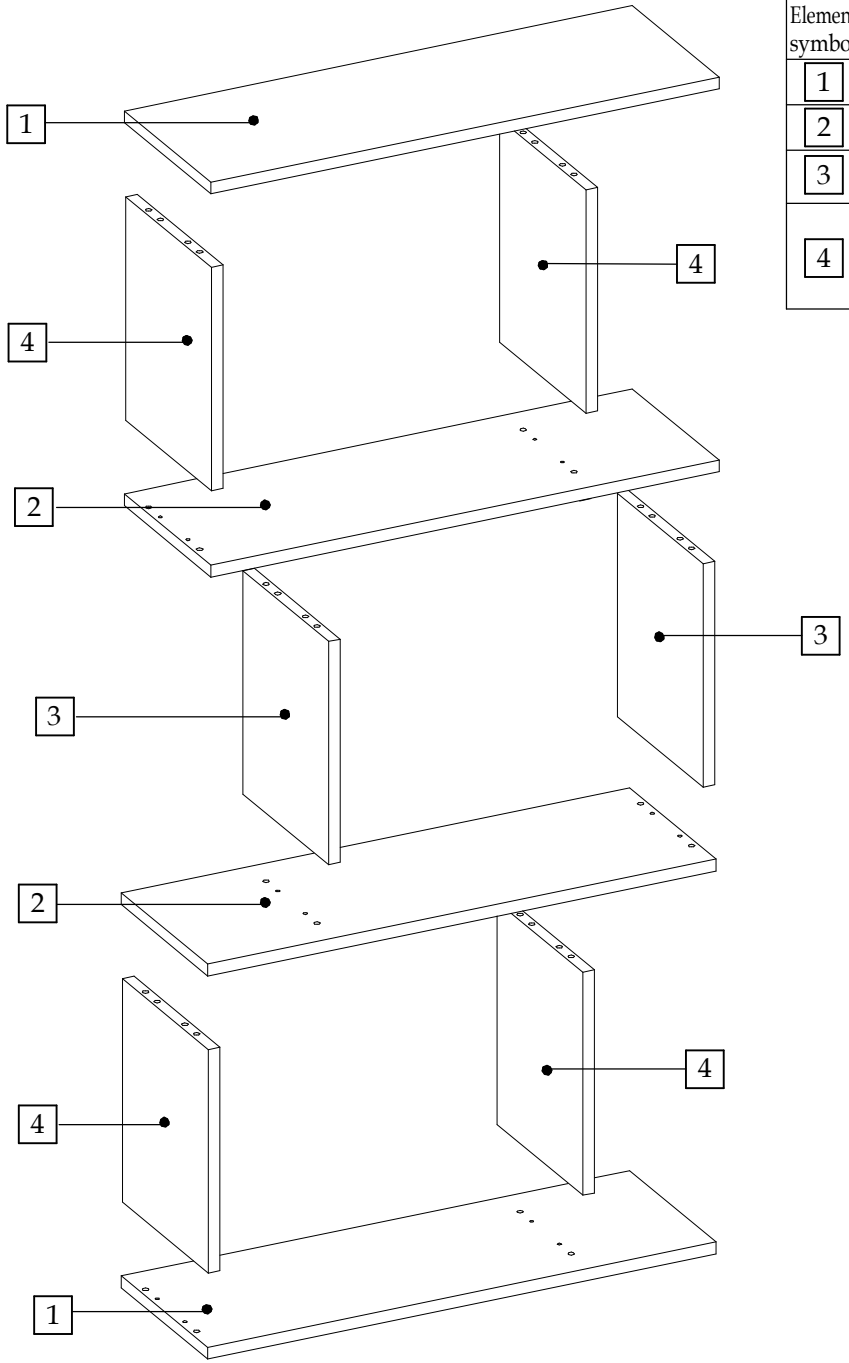
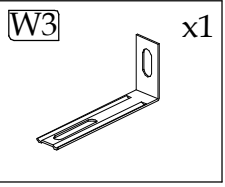
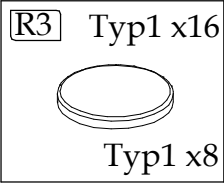
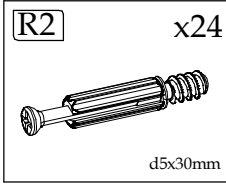
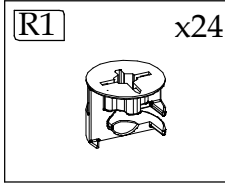
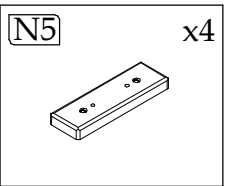
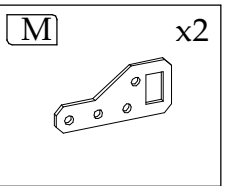
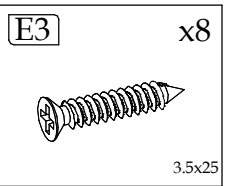
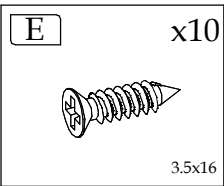
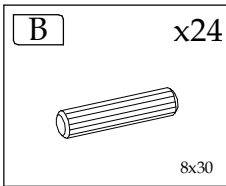
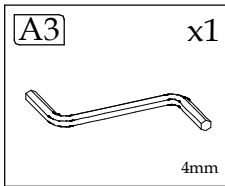

Element symbol	Measurements				Code	Paket
1	700	238	16	2	1033/1039	1/1
2	700	238	16	2	1024/1031	1/1
3	302	236	16	2	1023/1032	1/1
4	302	236	16	4	1021/1022 1030/1029	1/1

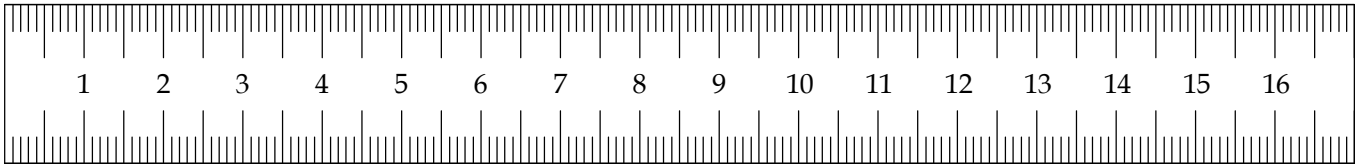
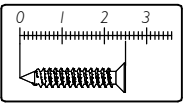
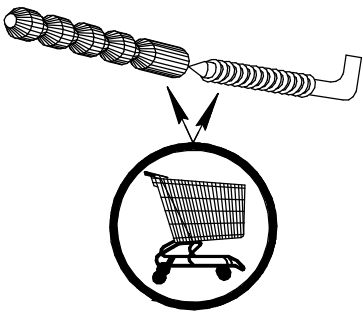

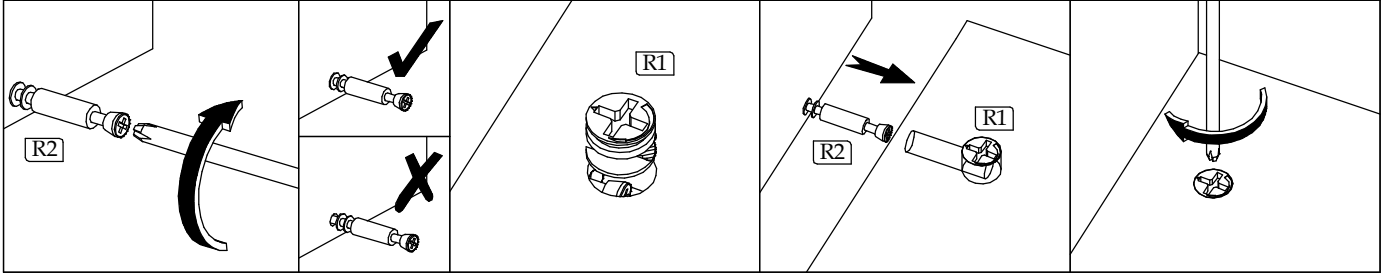

▶ 1

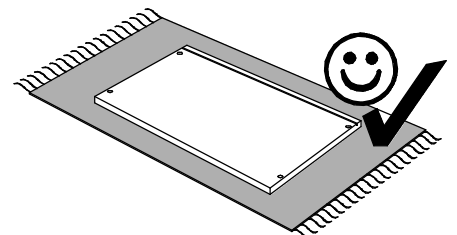
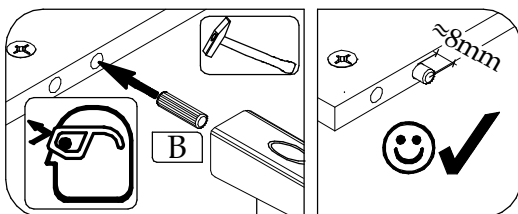
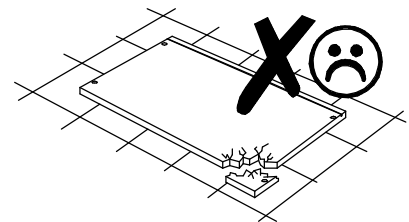
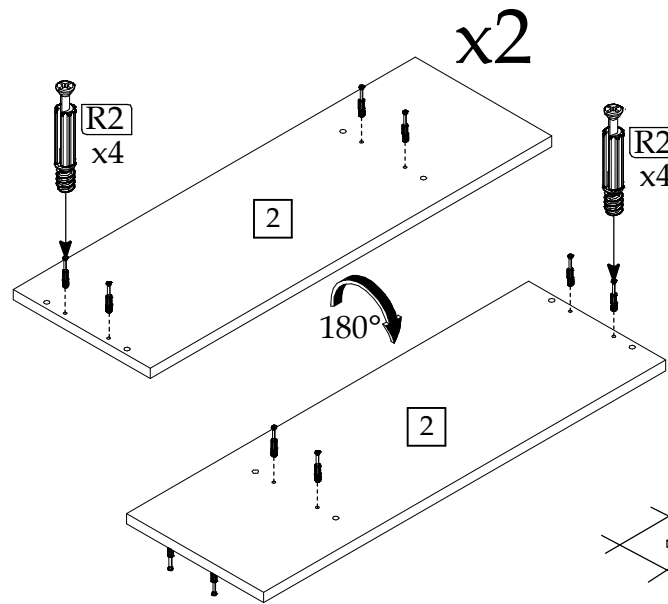
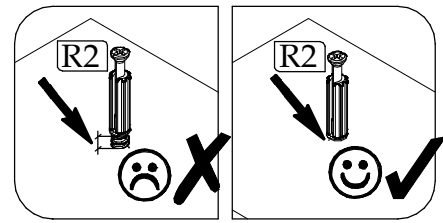
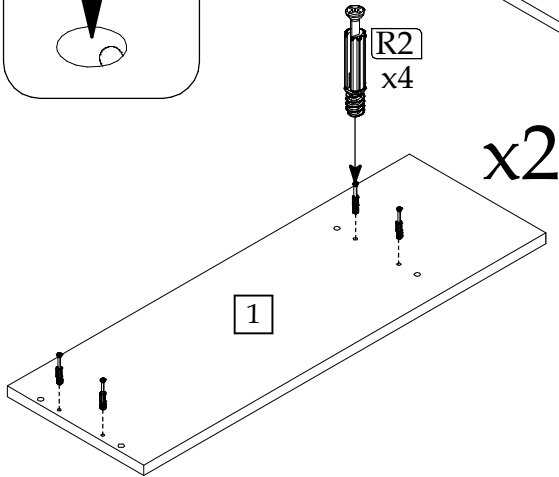
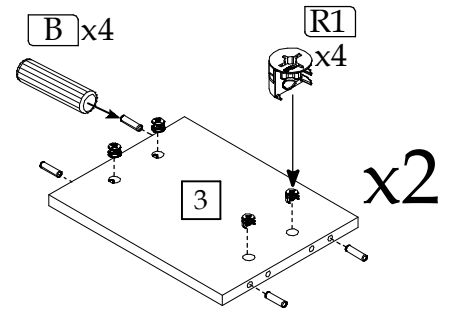
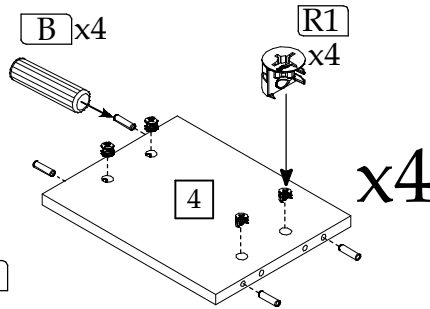
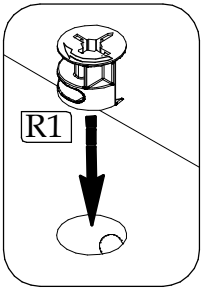

▶ 2

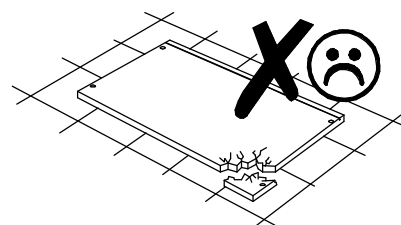
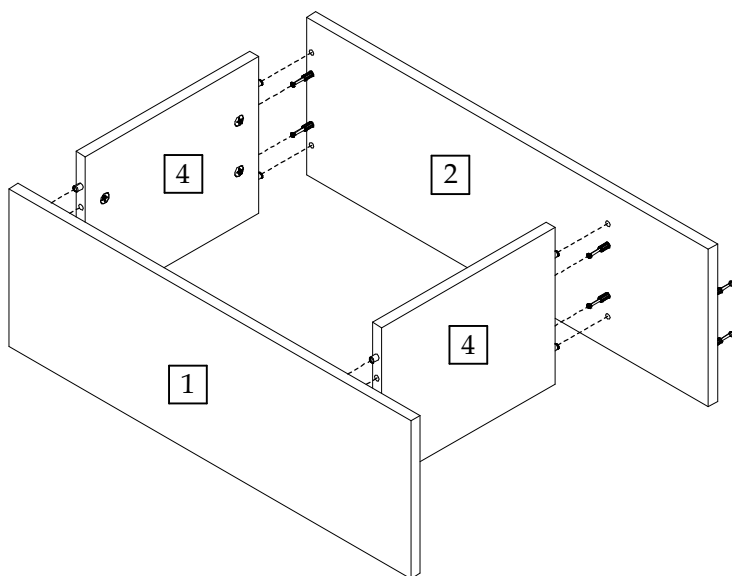

▶ 3

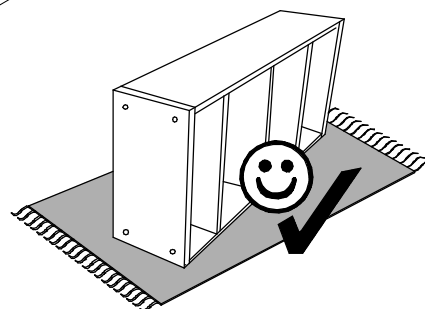
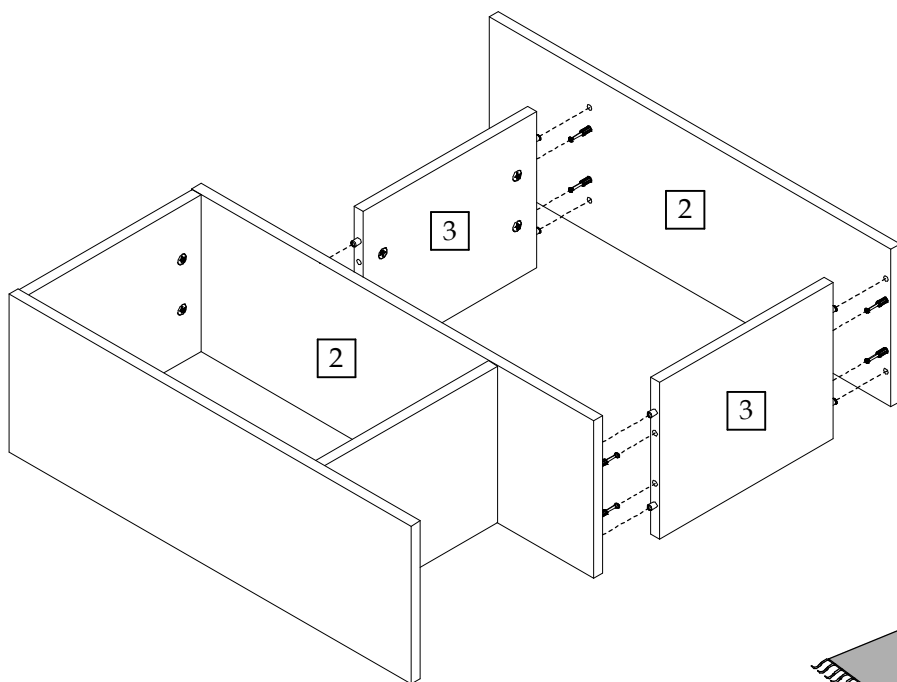
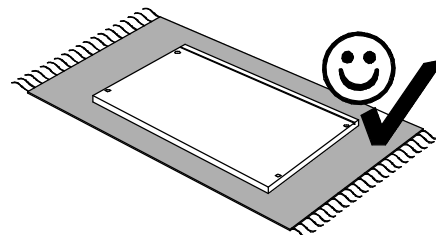
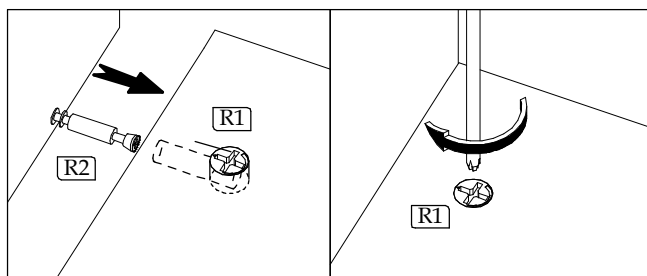

▶ 4

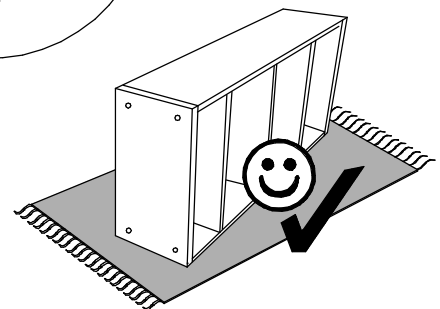
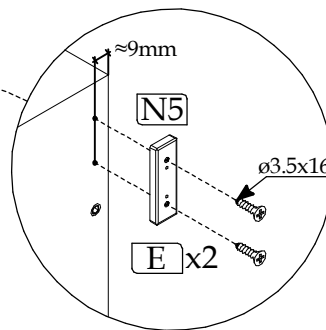
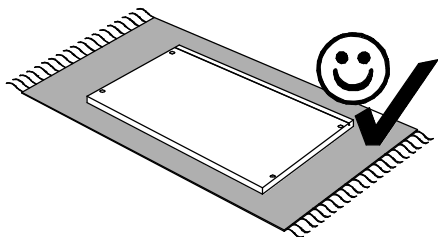
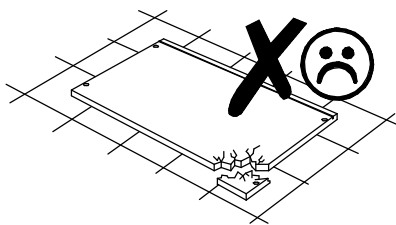
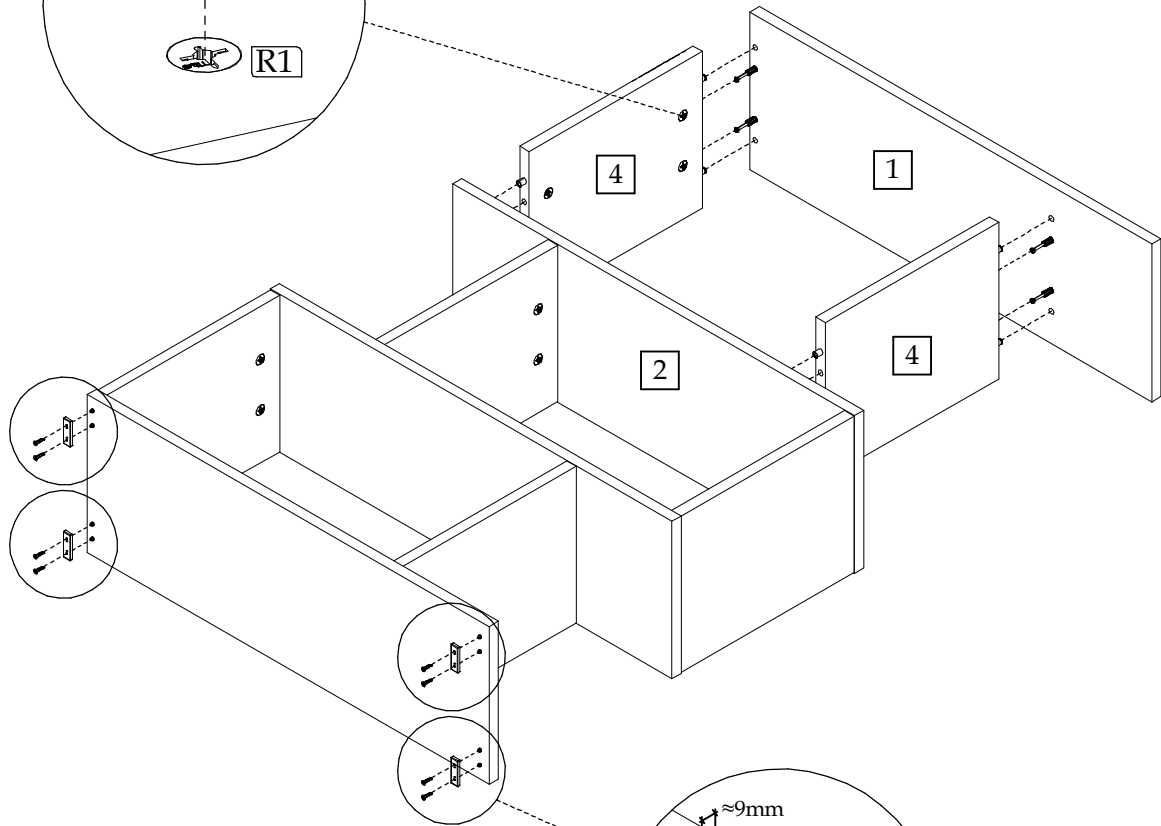
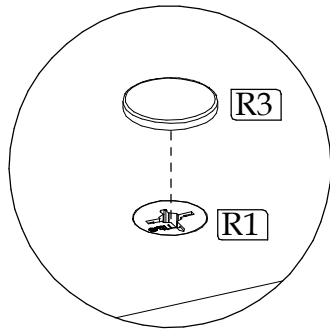
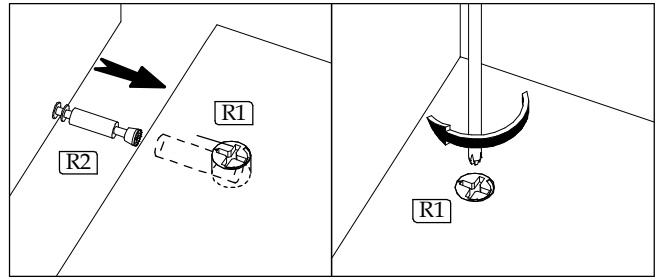

► 5

