

# THOME SPLIT I

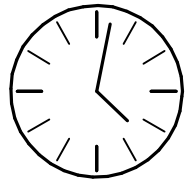

50 min

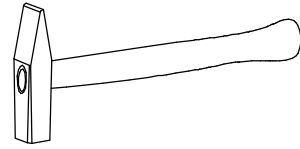

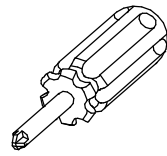
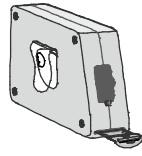
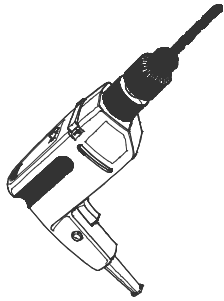
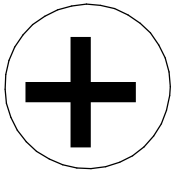
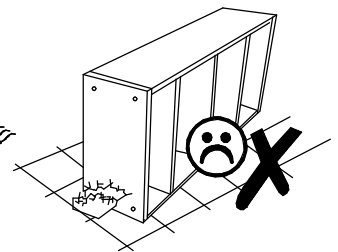
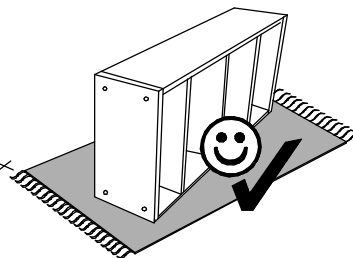
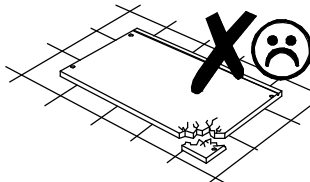
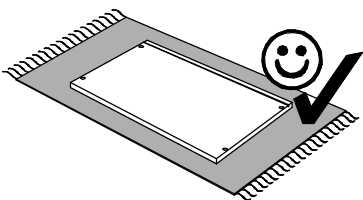
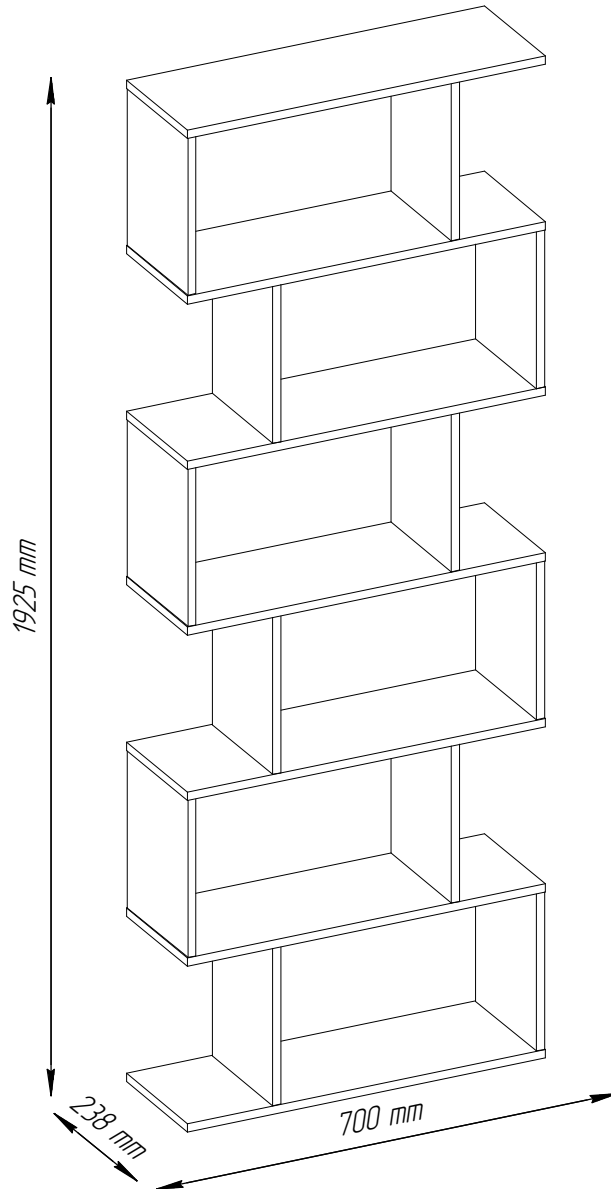
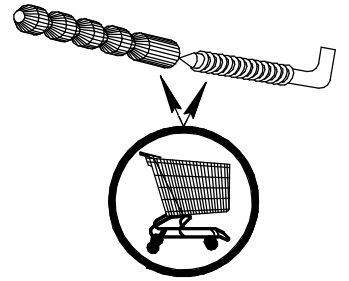
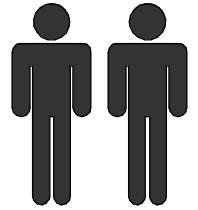
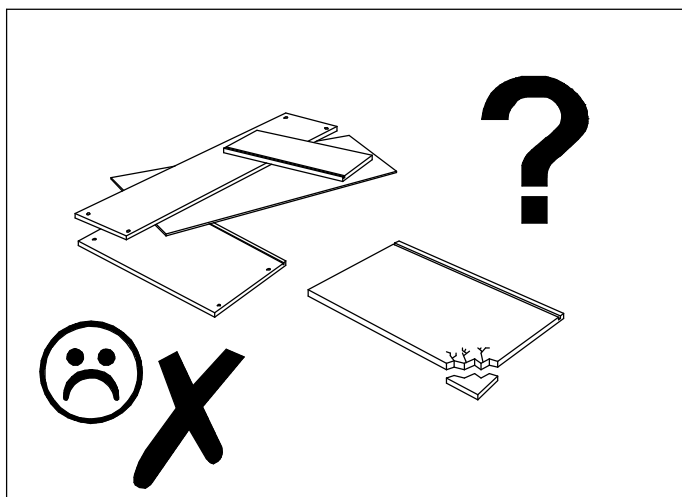
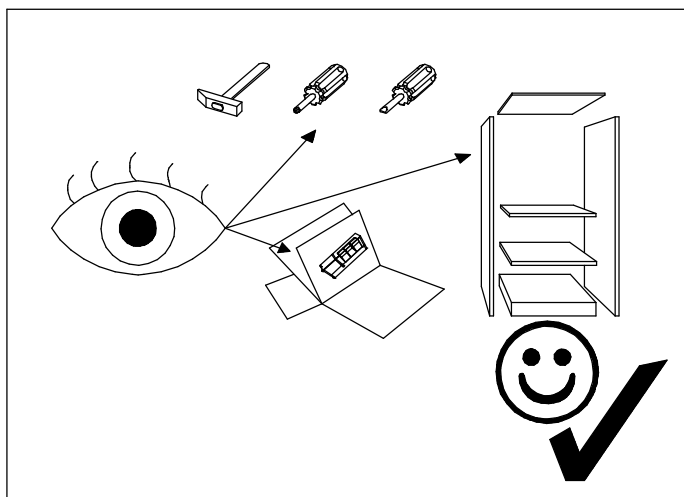
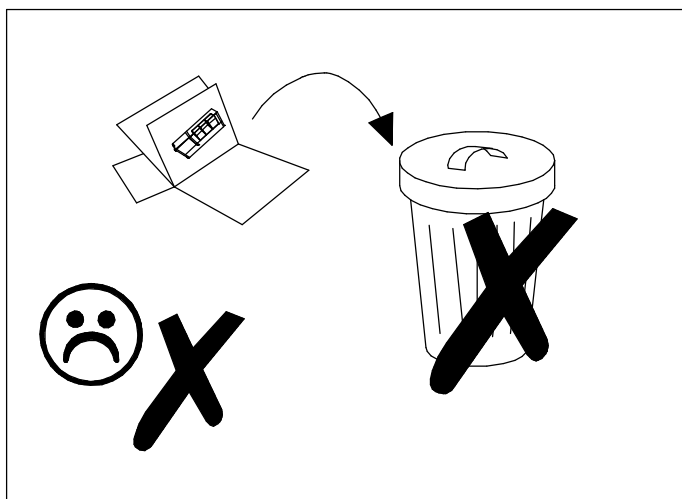
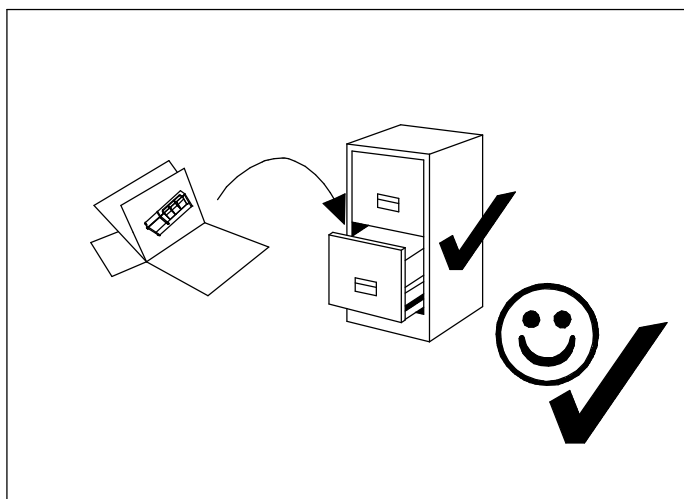

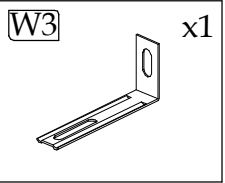
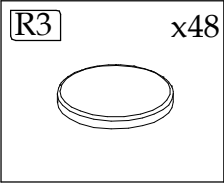
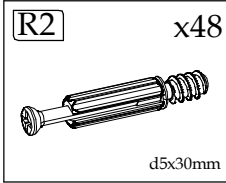
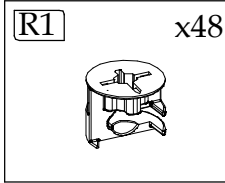
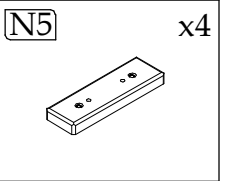
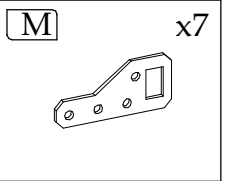
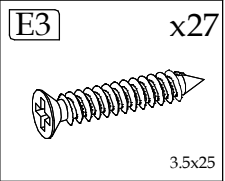
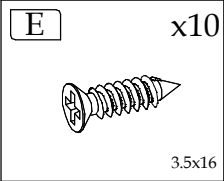
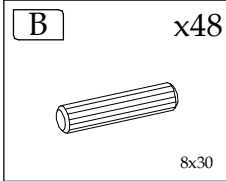
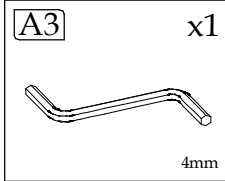

Element symbol	Measurements				Code	Paket
	1	2	3	4		
<b>1</b>	700	238	16	2	1039/1042	1/1
<b>2</b>	700	238	16	5	1024/1031/1033/ 1035/1040	1/1
<b>3</b>	302	236	16	12	1021/1022/1023/ 1029/1030/1032/ 1034/1036/1037/ 1038/1041/1043	1/1

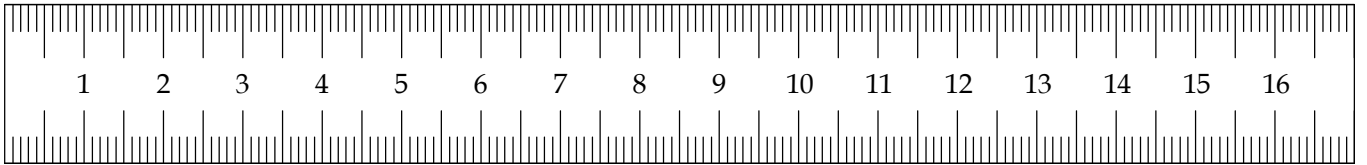
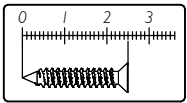
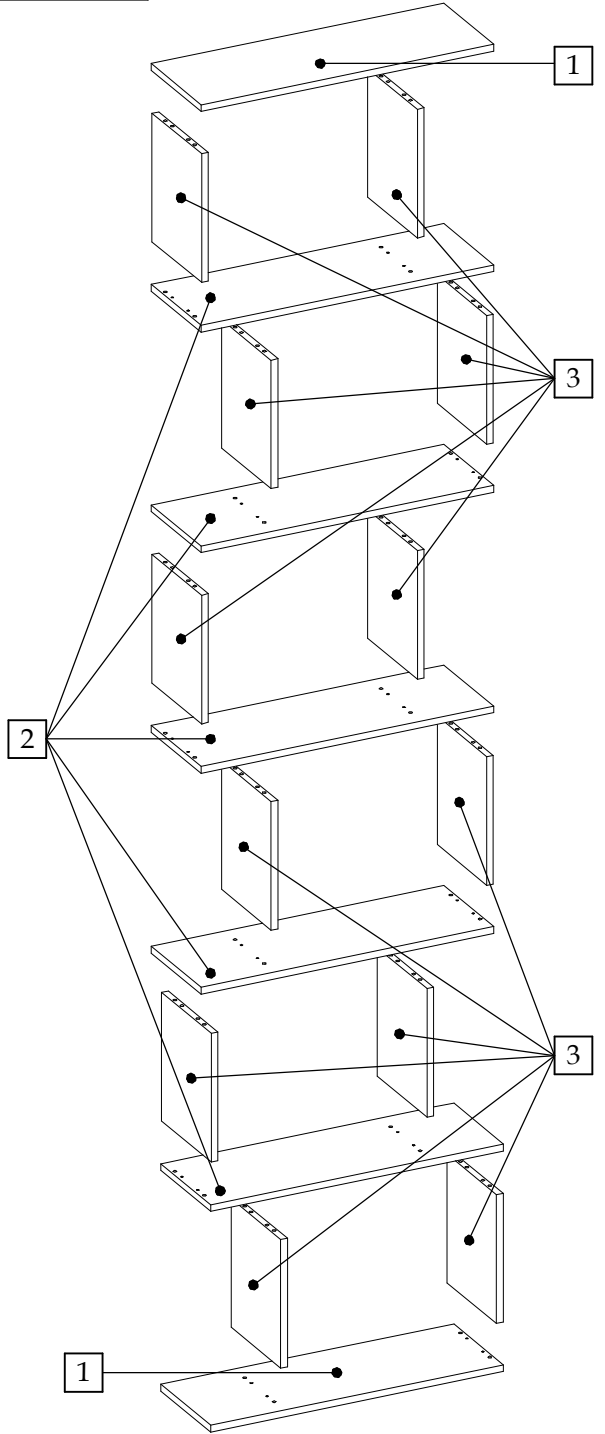

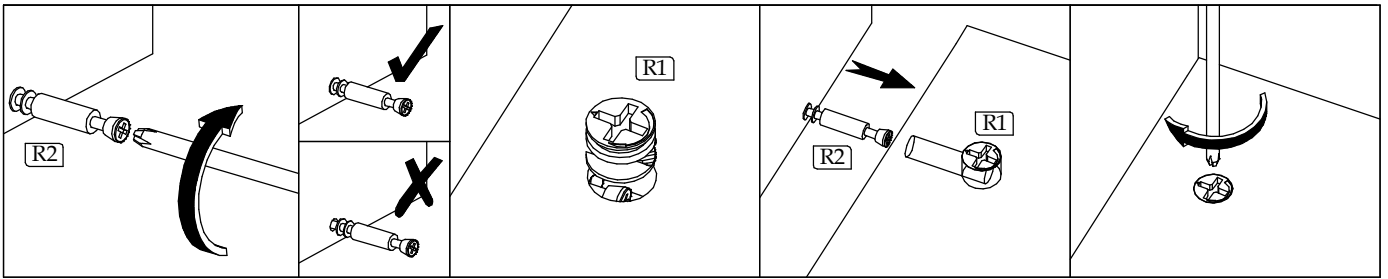

▶ 1

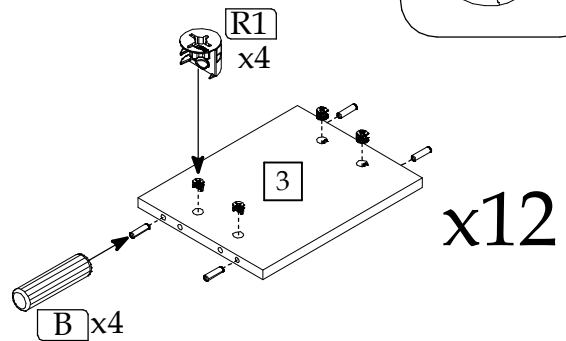
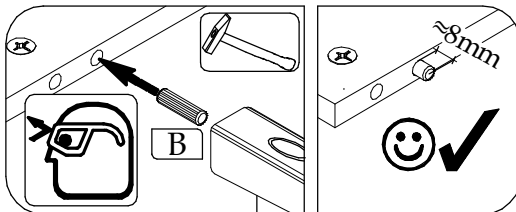
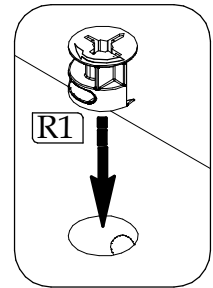
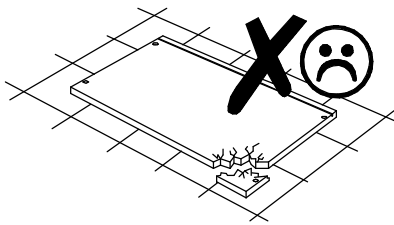
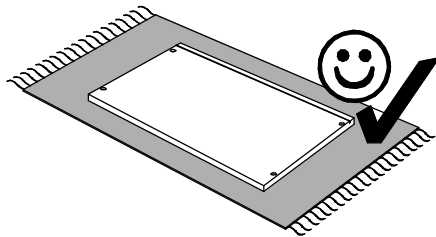
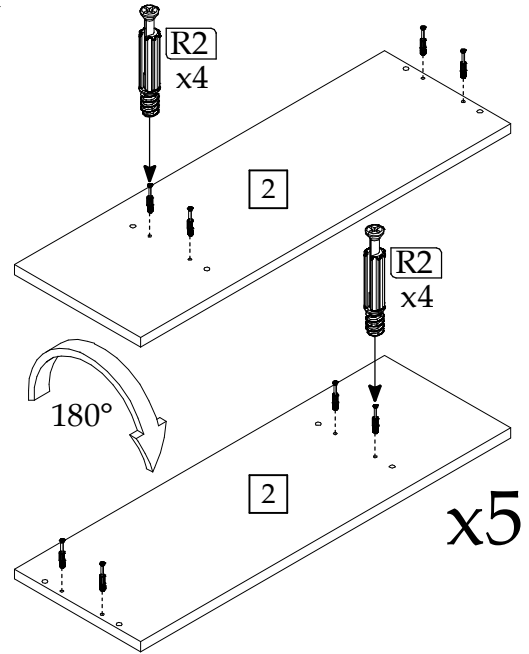
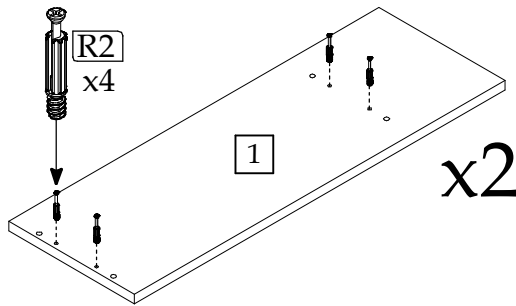
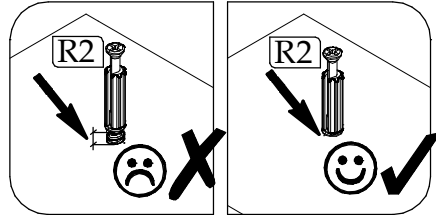

▶ 2

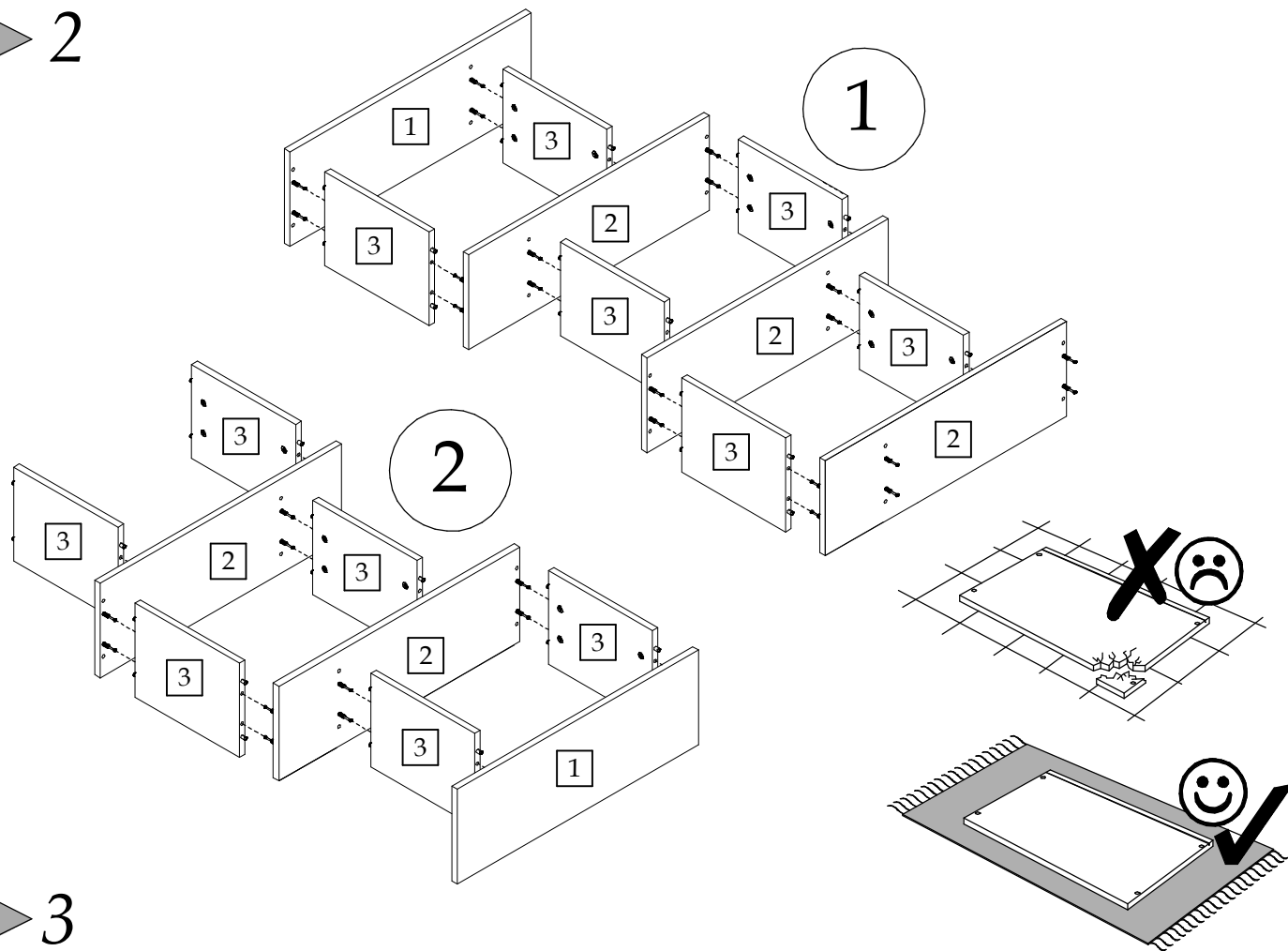

▶ 3

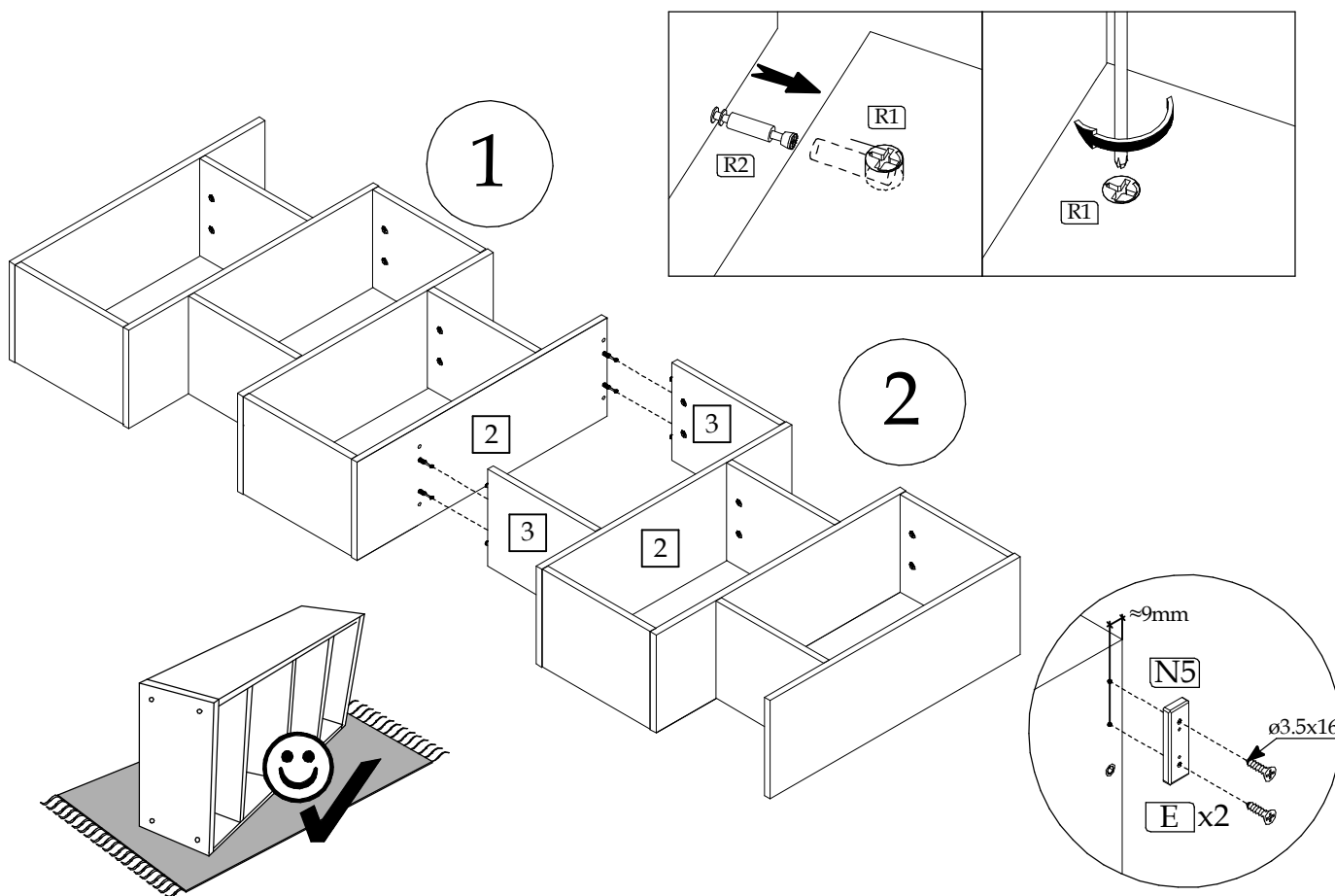

▶ 4

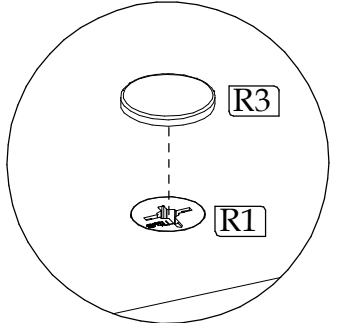
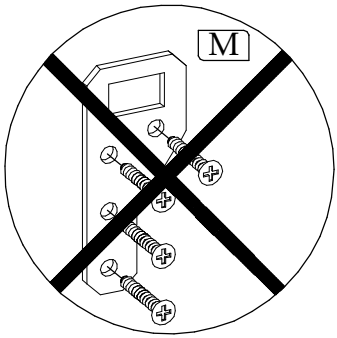
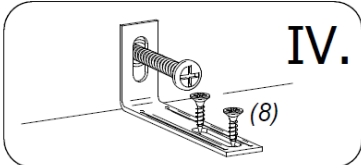
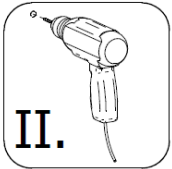
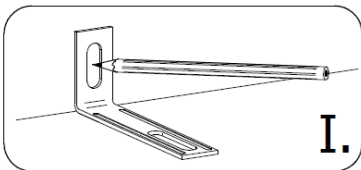
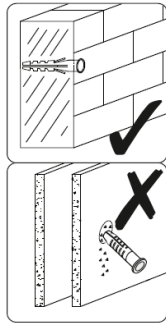
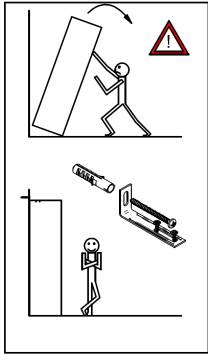
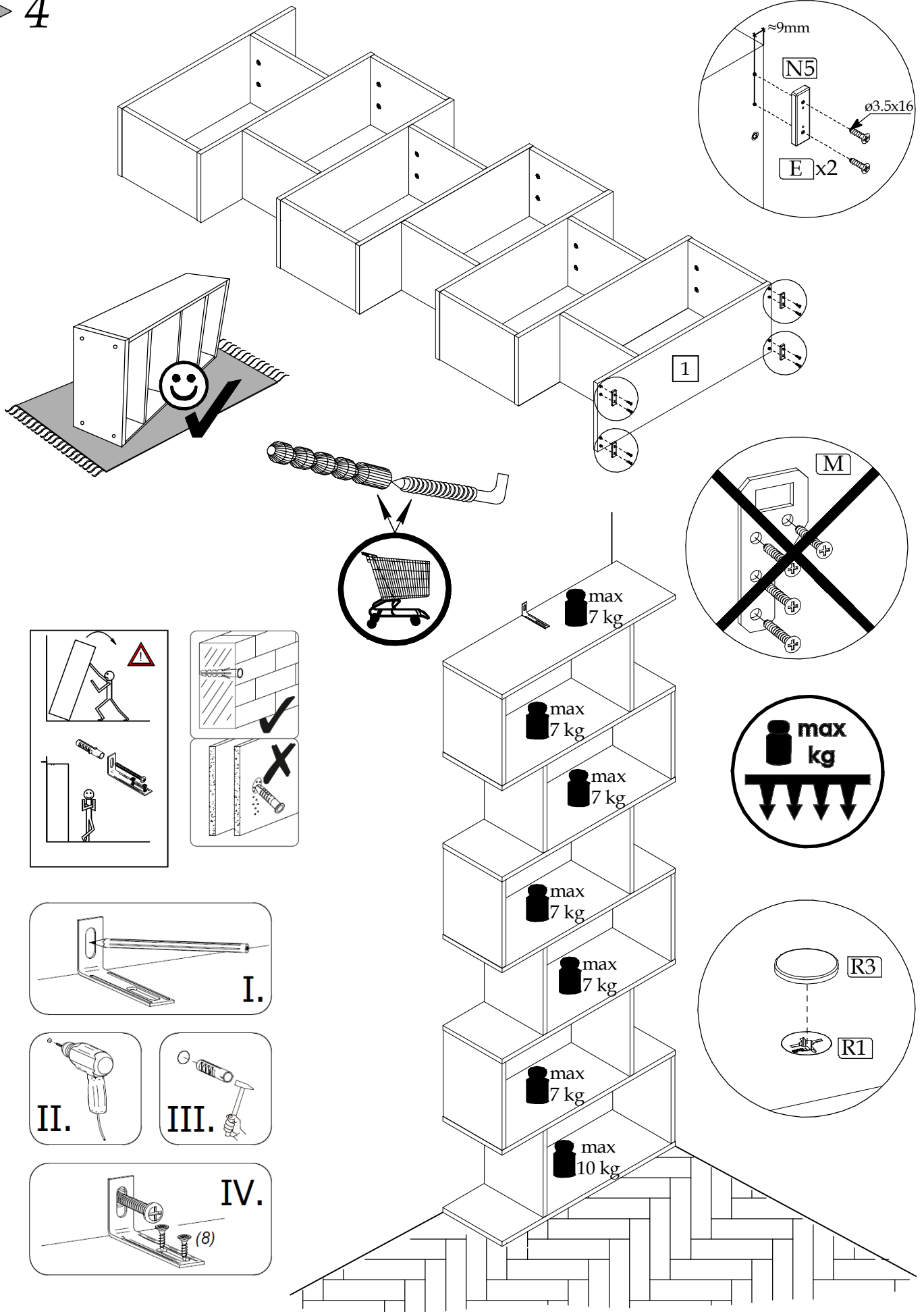

5

