

TIRION D

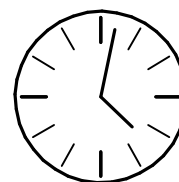

100 min

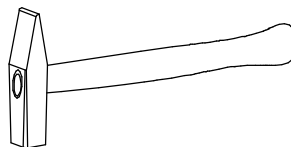

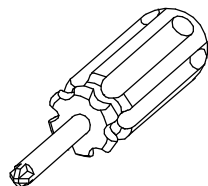
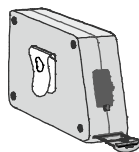
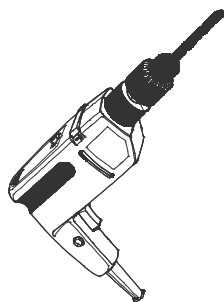
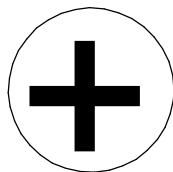
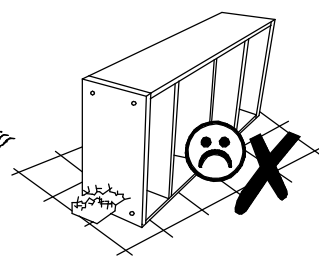
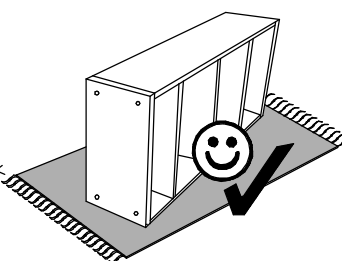
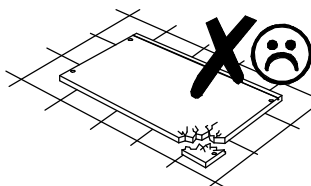
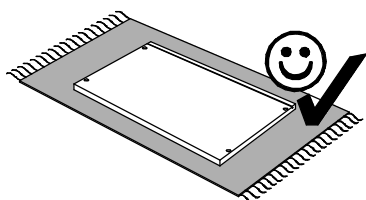
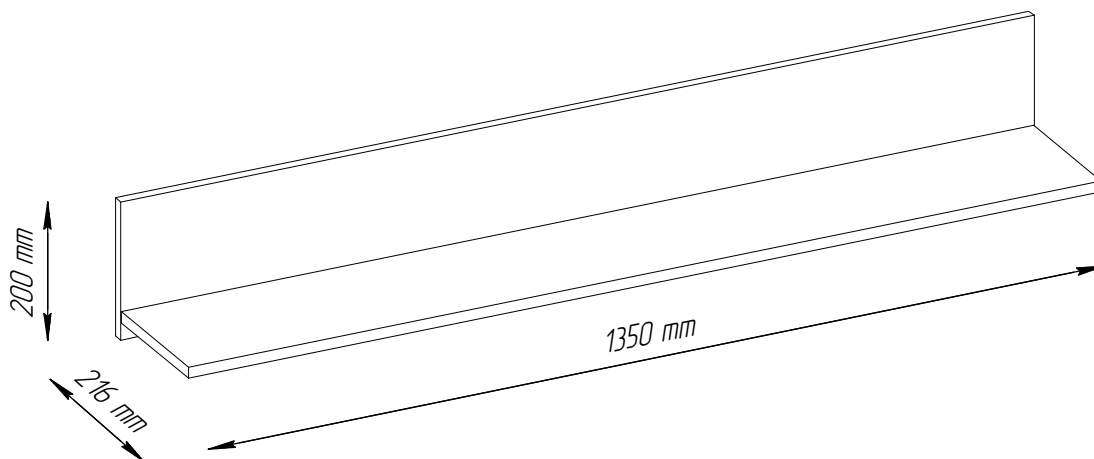
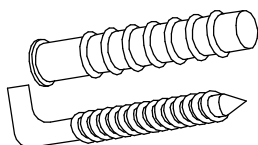
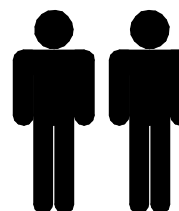
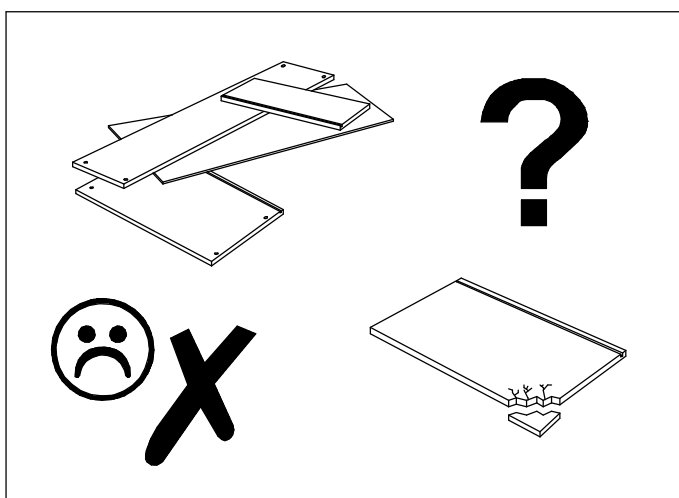
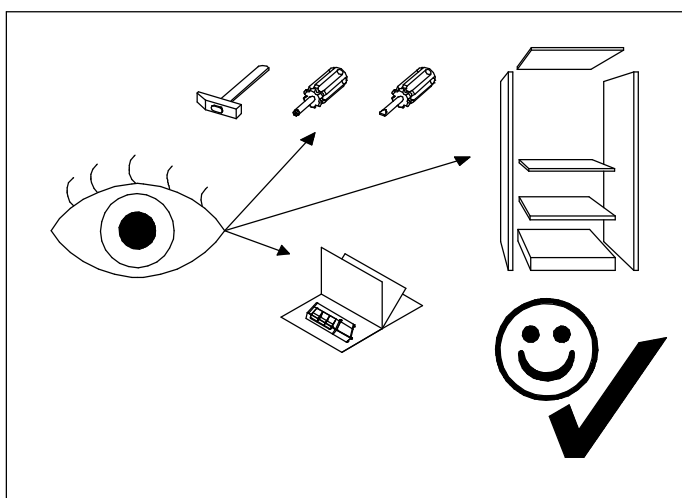
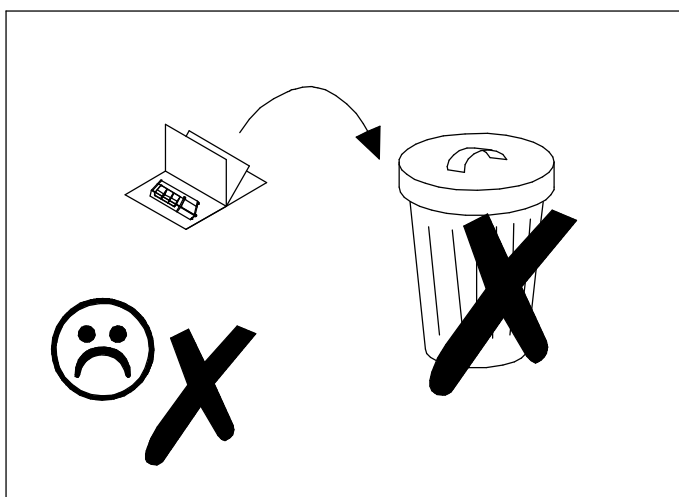
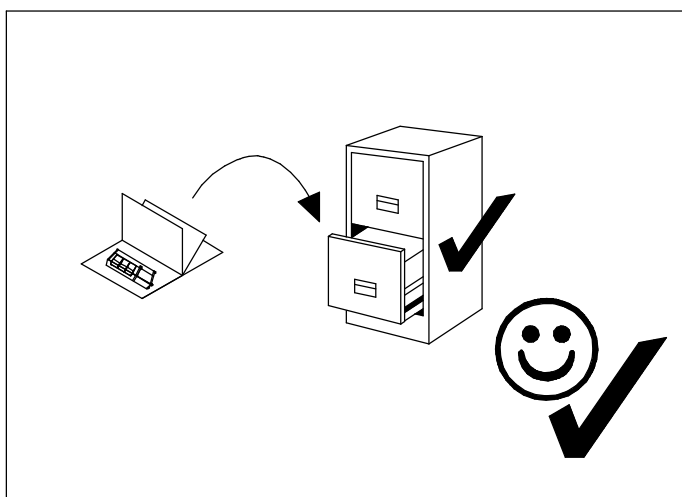
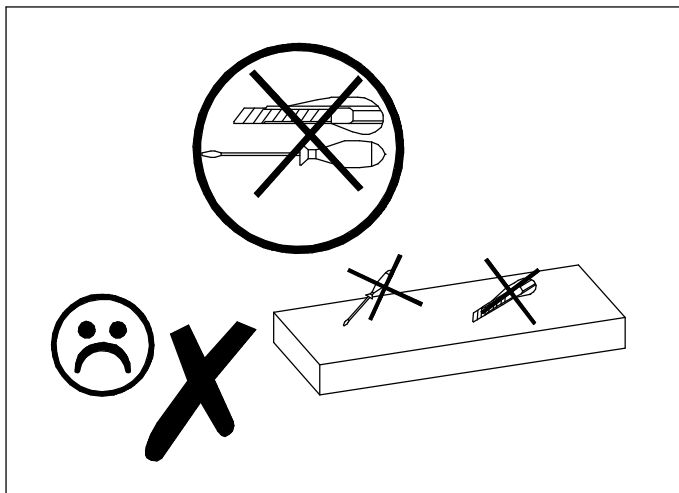
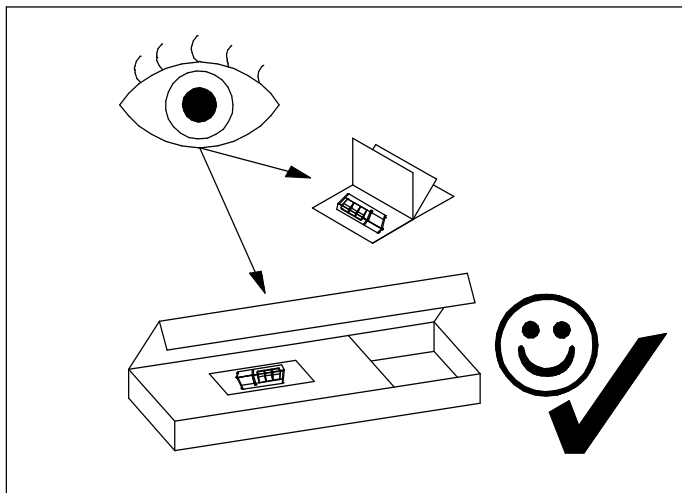

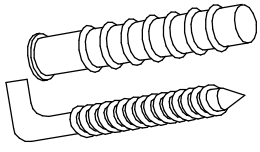
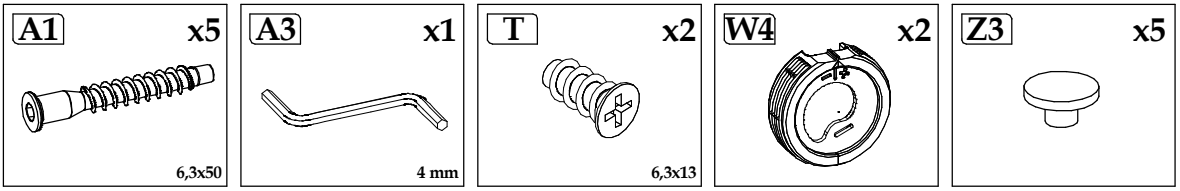

Element symbol	Measurements				Code	Pack
1	1350	200	16	1	1001	1/ 1
2	1348	200	16	1	1002	1/ 1

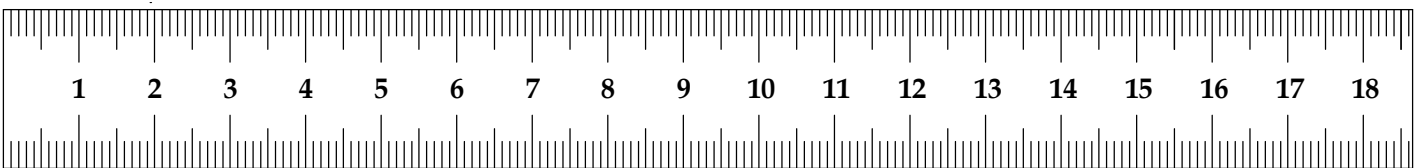
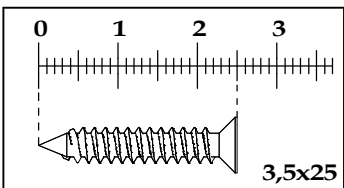
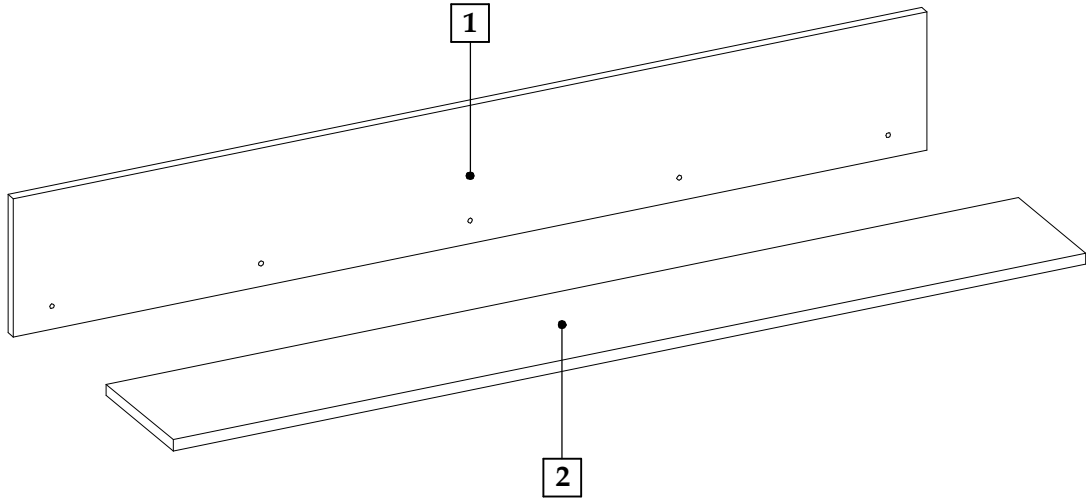

▶ 1

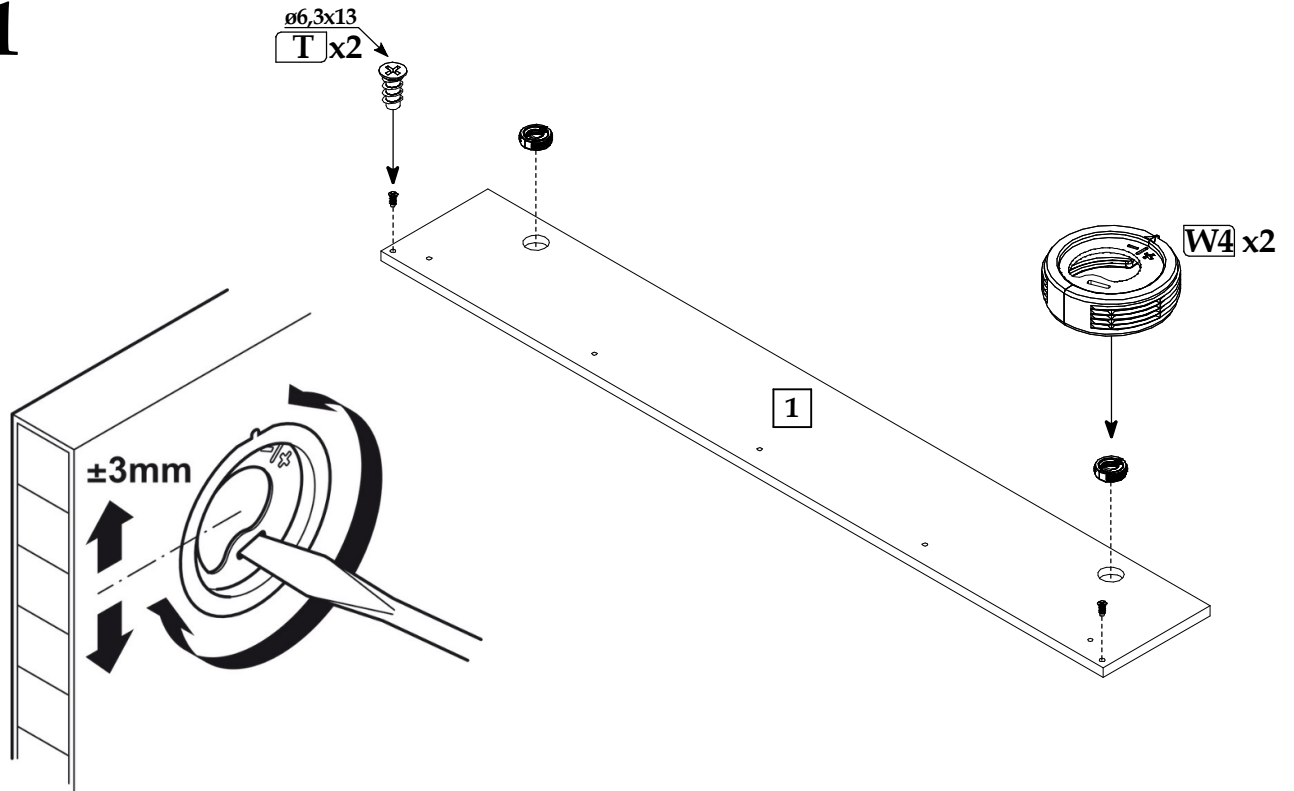

▶ 2

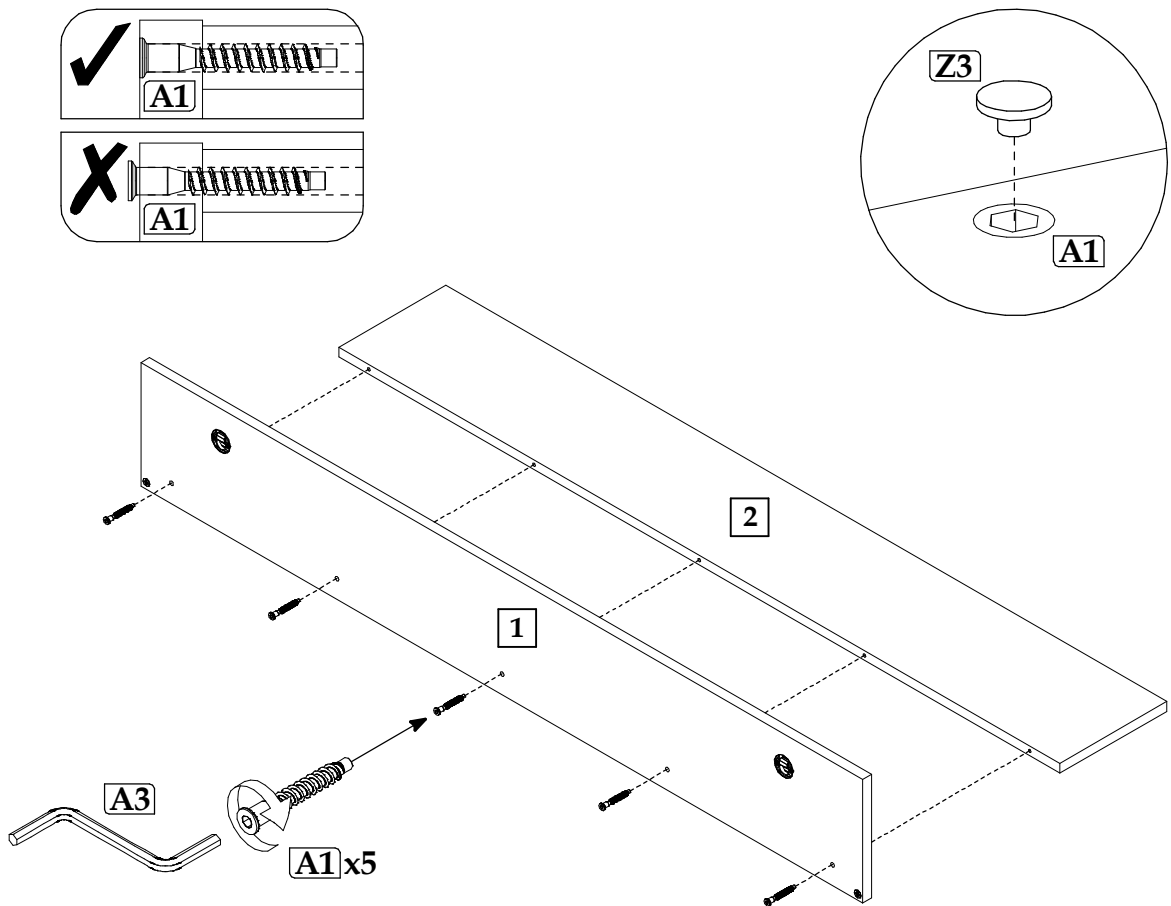

▶ 3

