

# Toronto

## Typ E

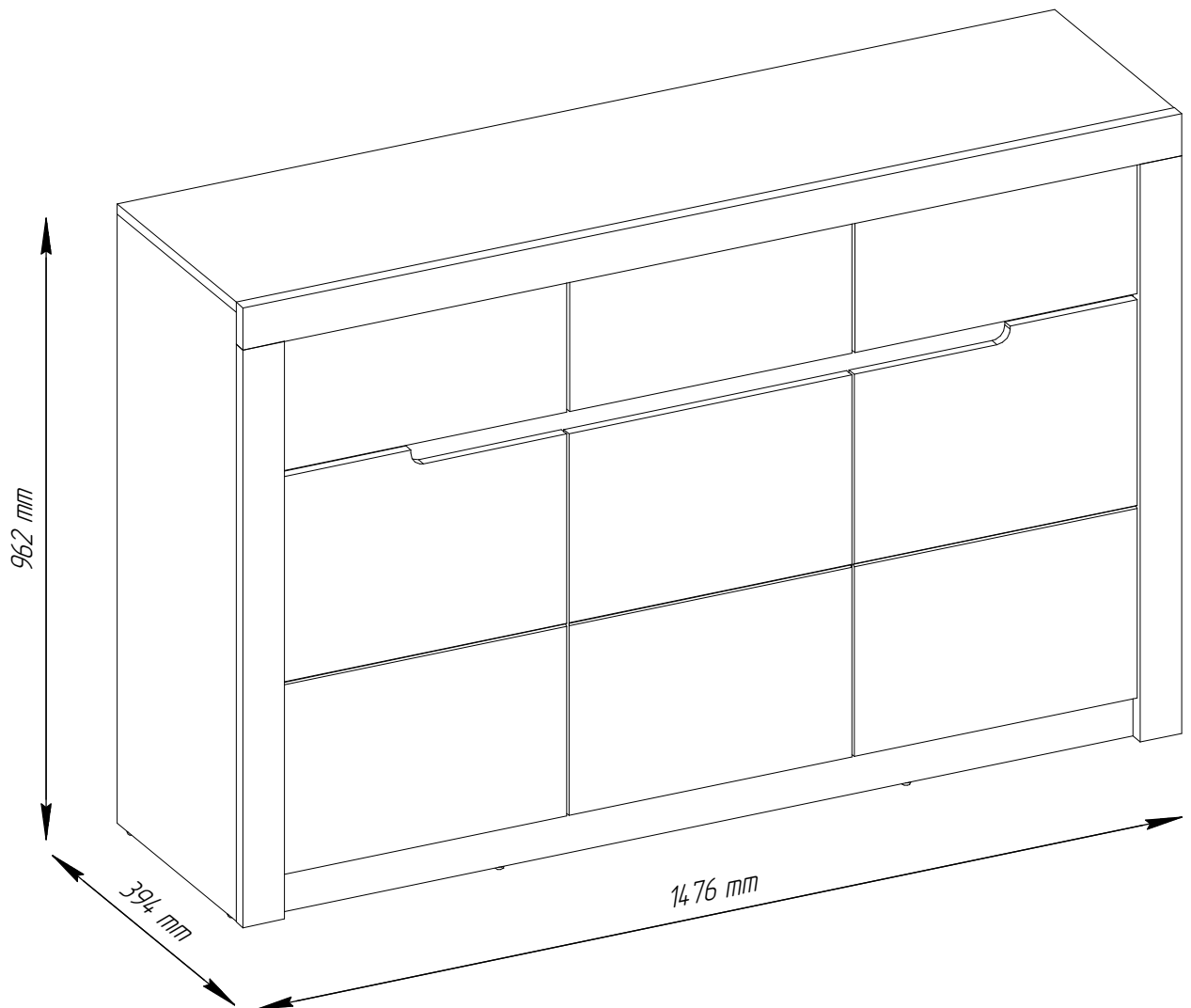

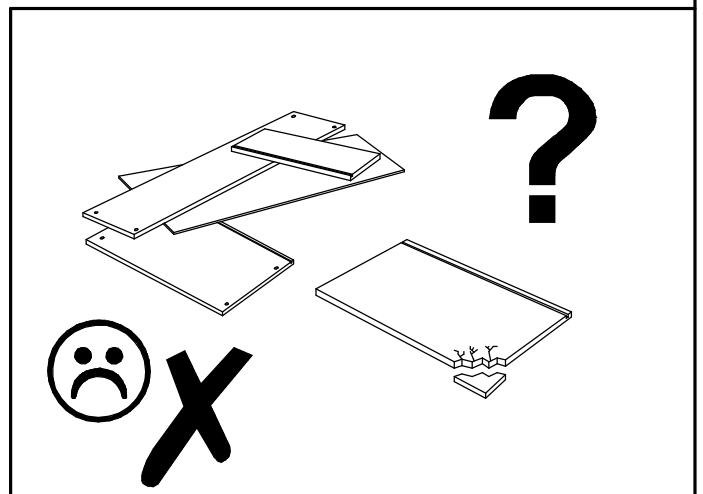

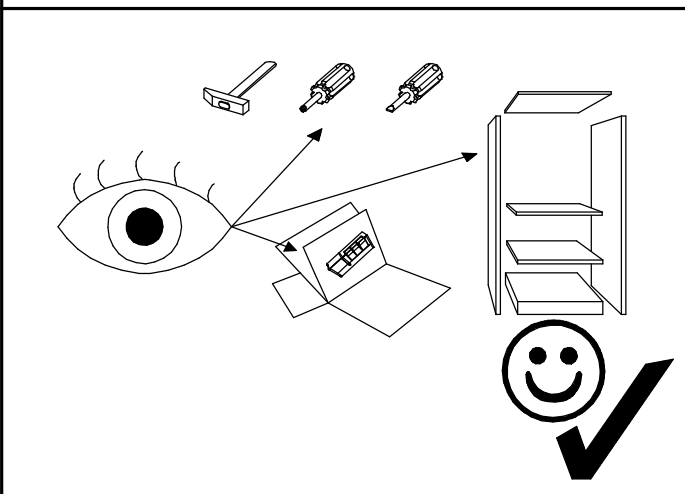
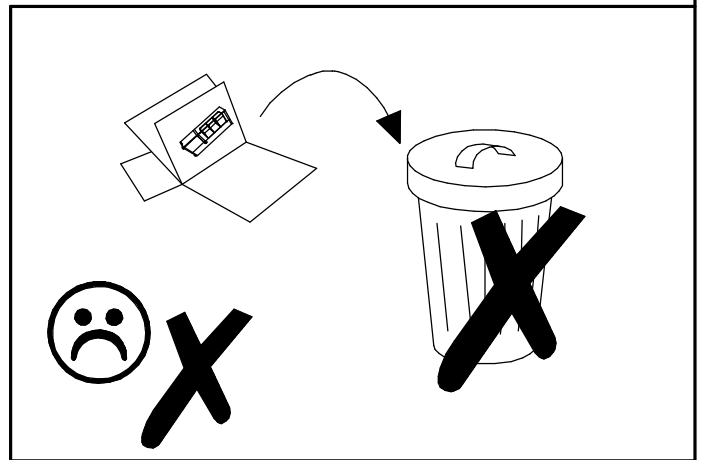
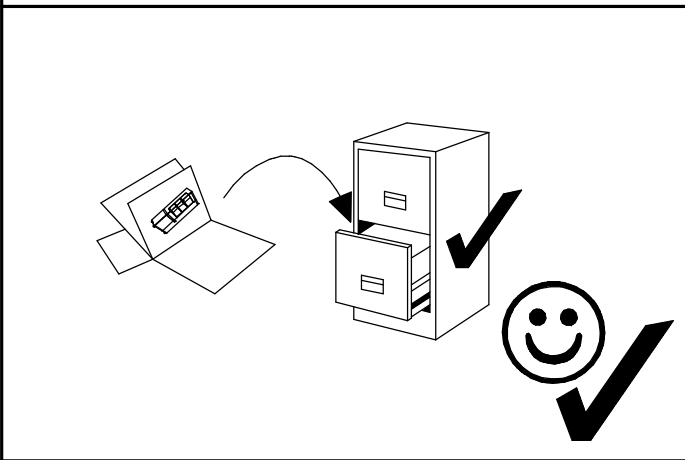
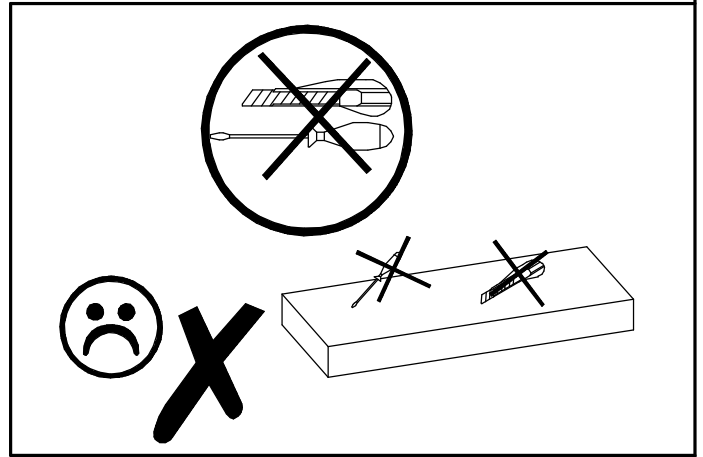
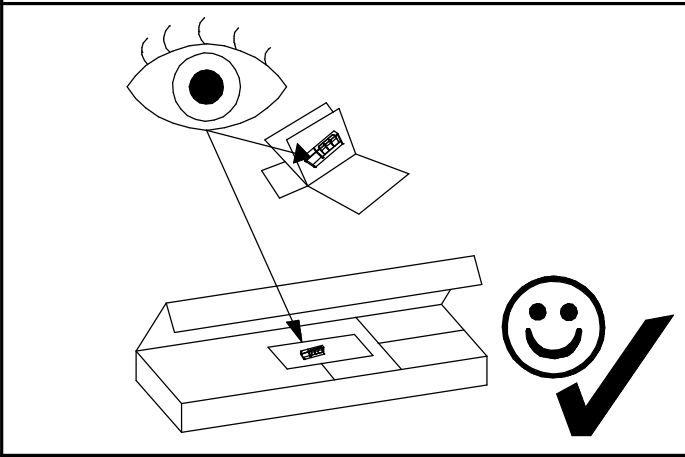
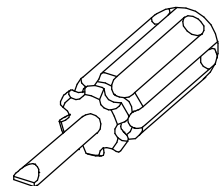
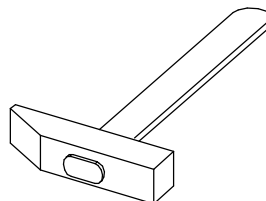
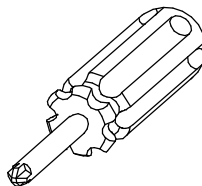
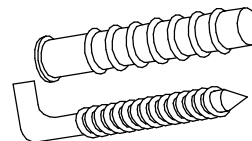
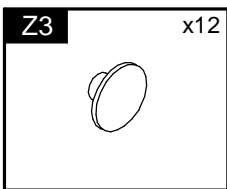
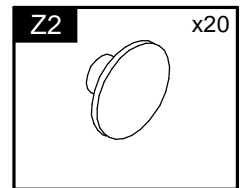
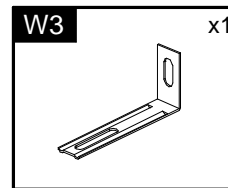
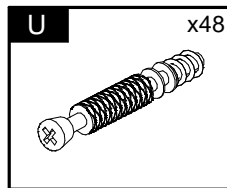
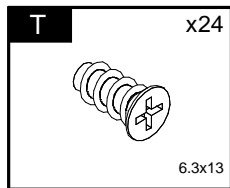
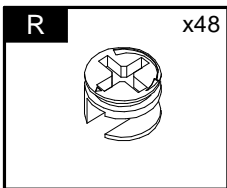
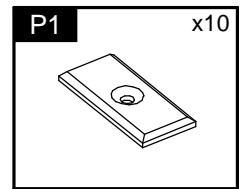
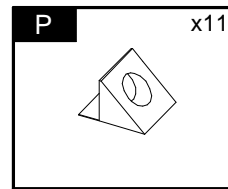
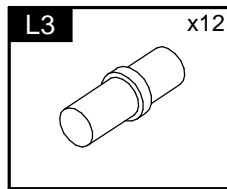
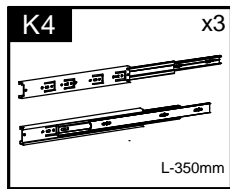
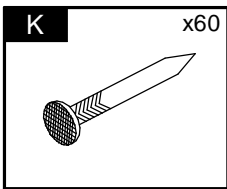
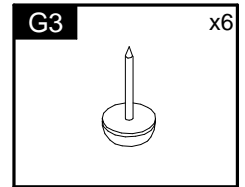
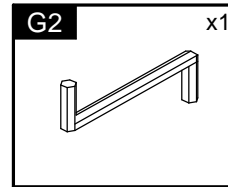
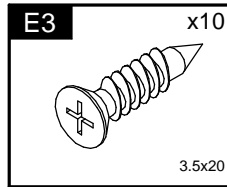
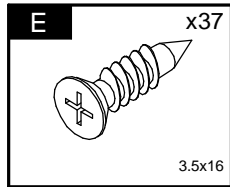
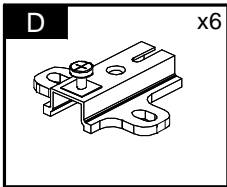
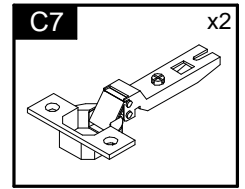
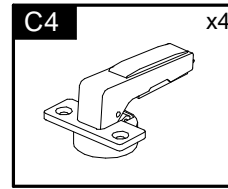
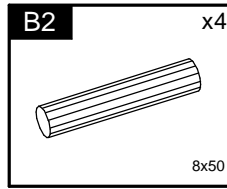
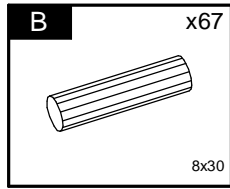
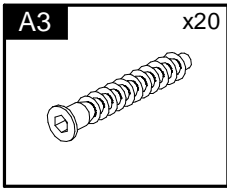
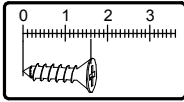
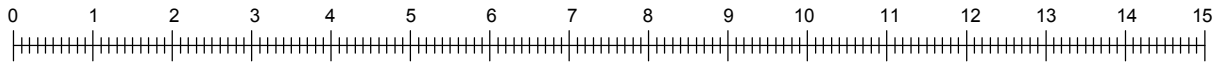

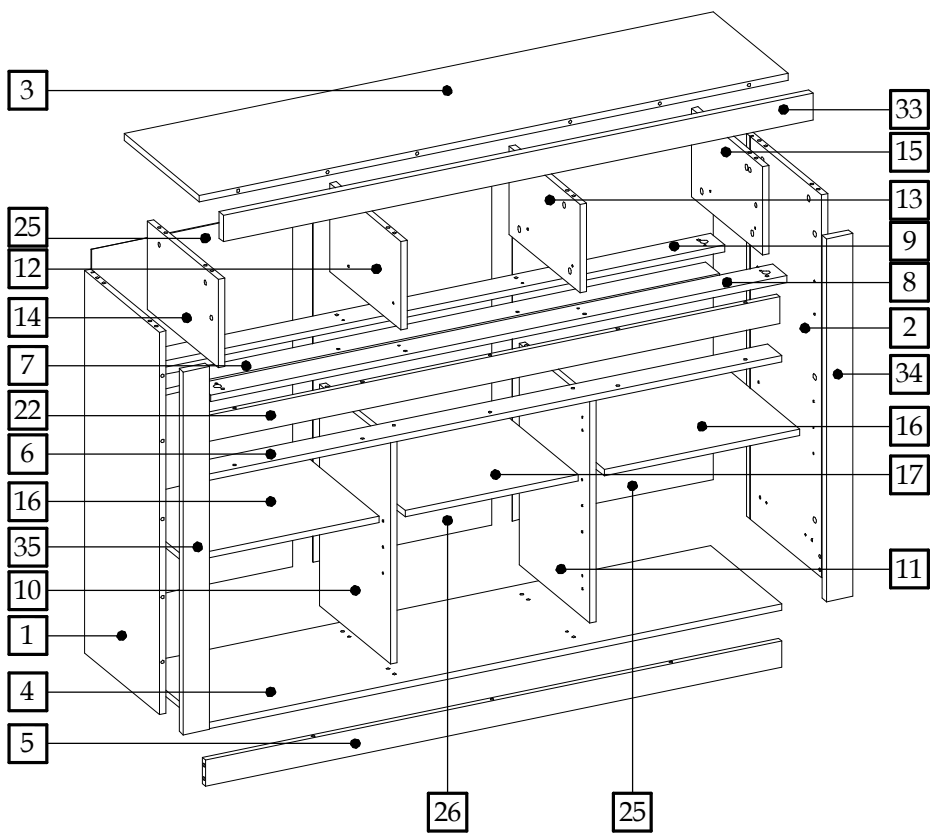
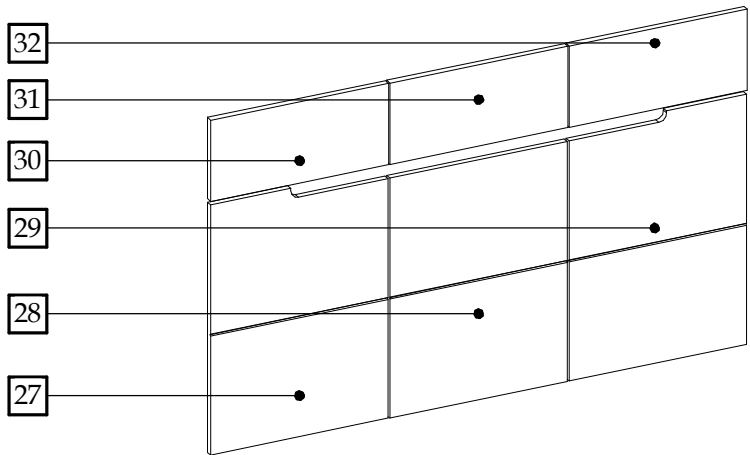
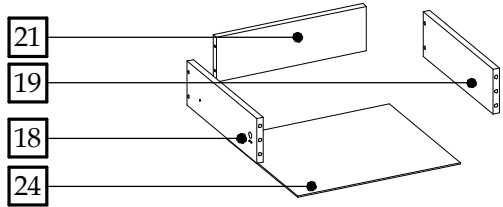
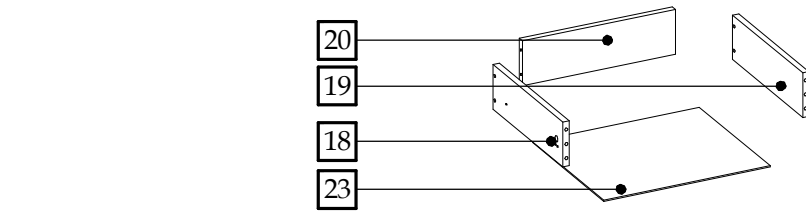

Element symbol	Measurements				Code	Paket
	1	2	3	4		
1	941	375	16	1	1002	2/3
2	941	375	16	1	1003	2/3
3	1476	375	16	1	1004	1/3
4	1443	355	16	1	1005	1/3
5	1443	65	16	1	1007	1/3
6	1443	70	16	1	1008	1/3
7	1443	70	16	1	1009	1/3
8	1443	70	16	1	1010	1/3
9	1443	70	16	1	1011	1/3
10	545	354.5	16	1	1001	2/3
11	545	354.5	16	1	1012	2/3
12	218	354.5	16	1	1017	1/3
13	218	354.5	16	1	1018	1/3
14	218	354.5	16	1	1019	2/3
15	218	354.5	16	1	1030	1/3
16	489	345	16	2	N/A	1/3 2/3
17	433	345	16	1	N/A	2/3
18	350	110	16	3	1021	1/3
19	350	110	16	3	1023	2/3
20	384	110	16	2	1022	1/3
21	375.5	110	16	1	1027	1/3
22	1443	65	16	1	1016	1/3
23	416	355	3	2	N/A	1/3
24	407	355	3	1	N/A	1/3
25	882	503	3	2	N/A	1/3
26	882	448	3	1	N/A	1/3
27	617	447	16	1	3037	3/3
28	592	447	16	1	3038	3/3
29	617	447	16	1	3039	3/3
30	447	202	16	1	3020	3/3
31	447	202	16	1	3025	3/3
32	447	202	16	1	3031	3/3
33	1476	65	19	1	4010	1/3
34	892	65	19	1	4011	1/3
35	892	65	19	1	4012	1/3

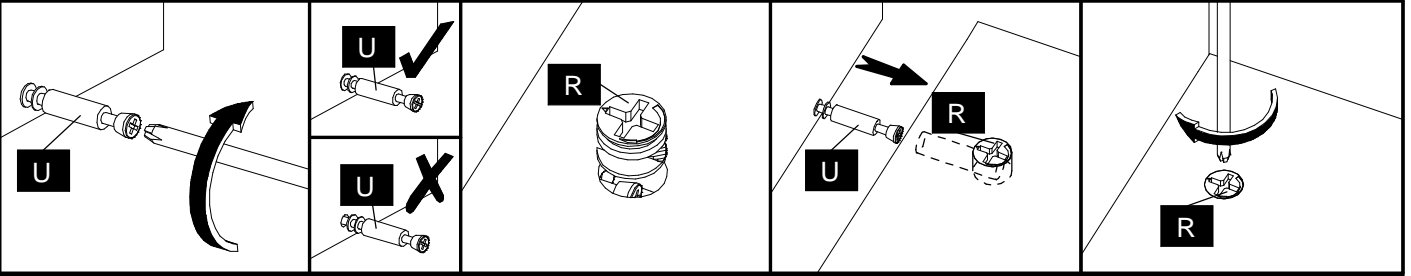

1

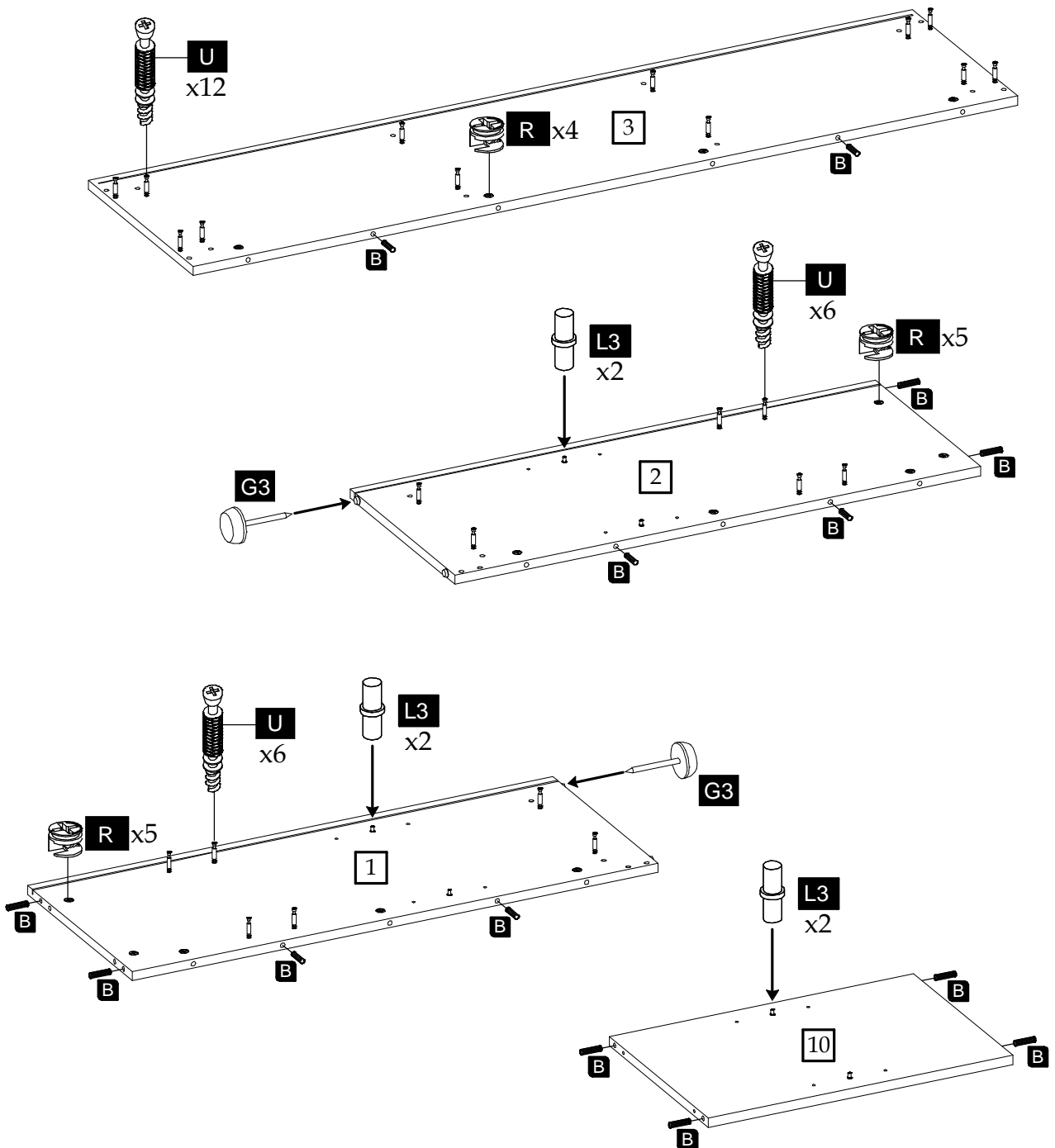

2

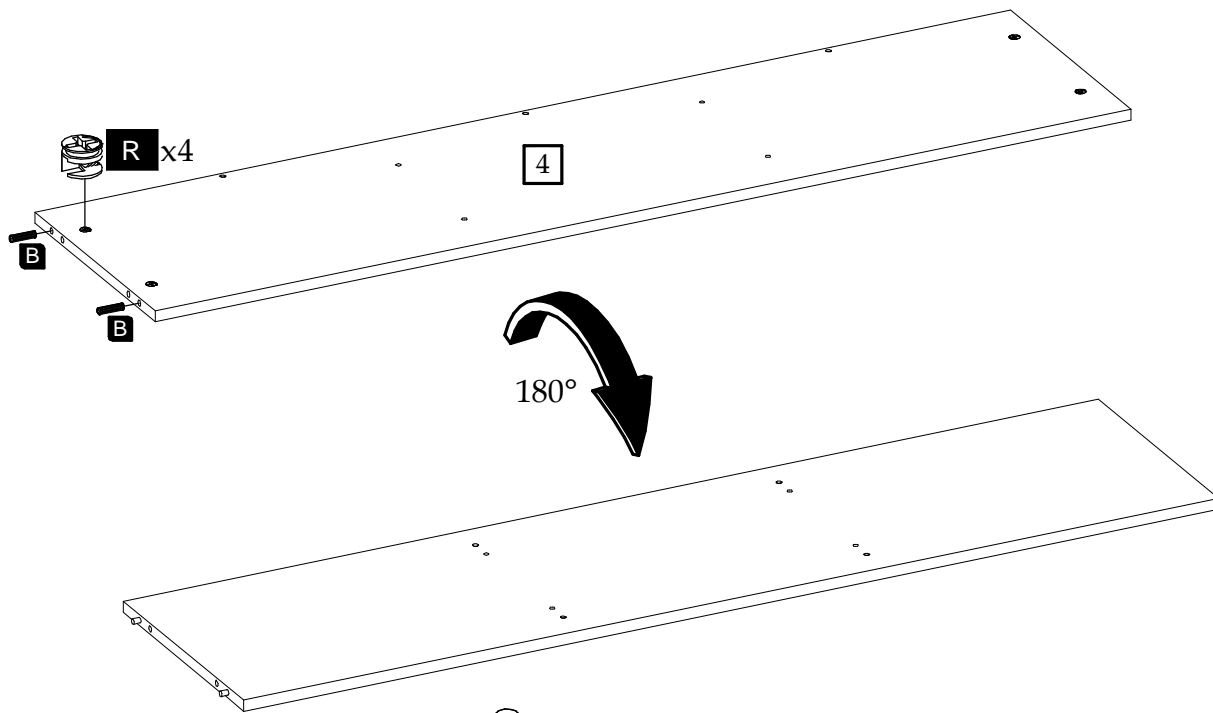

3

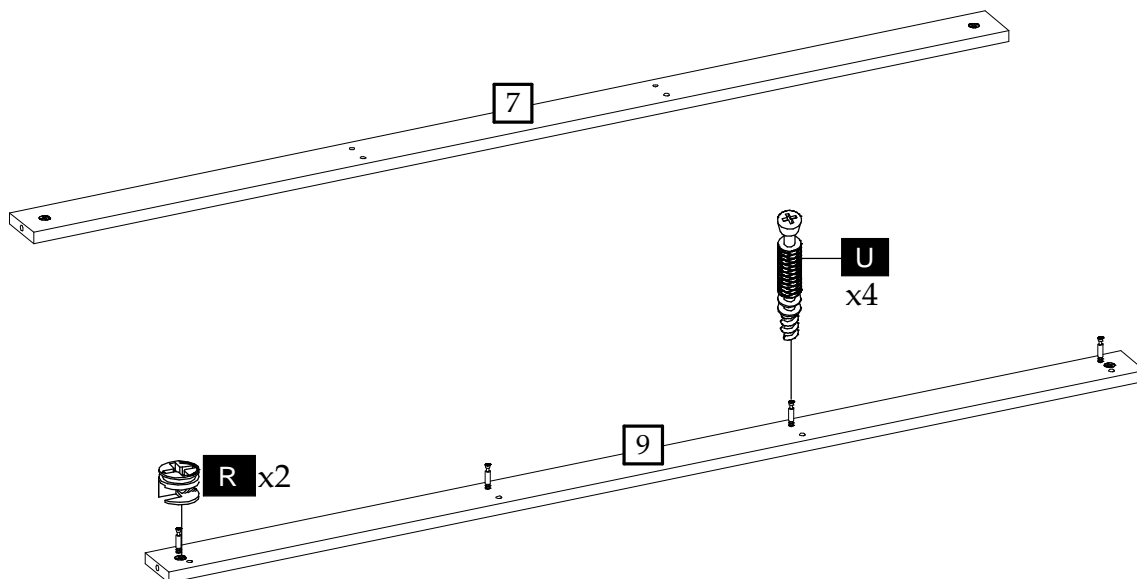
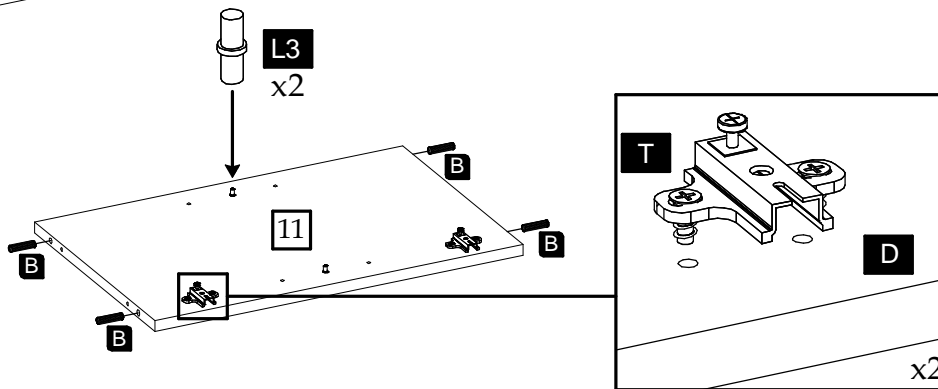

4

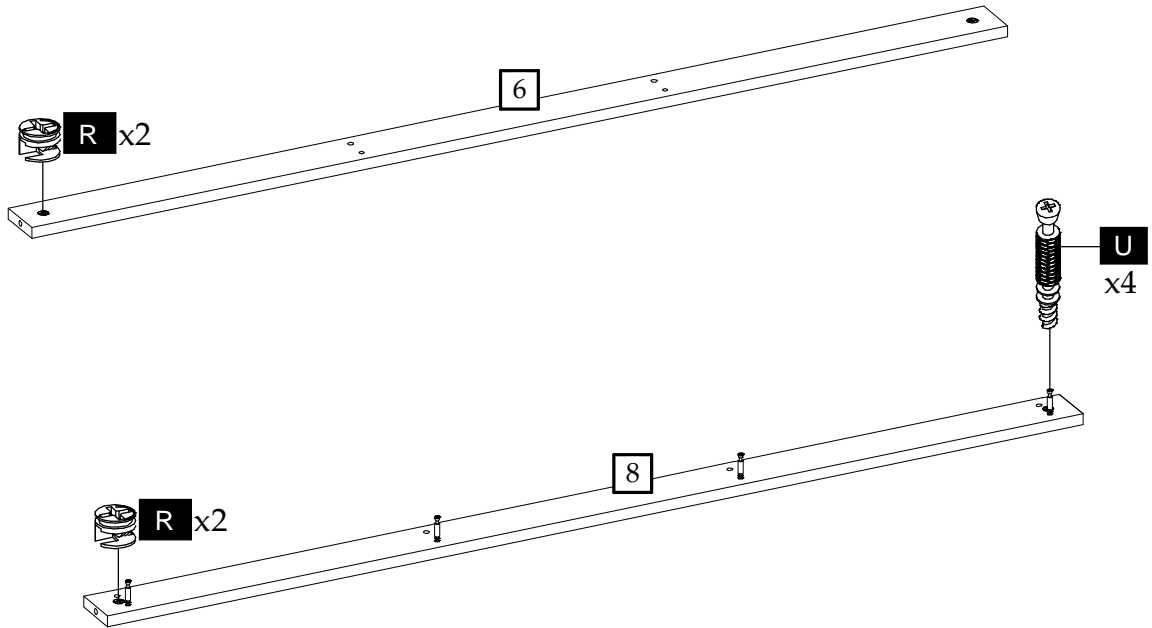

5

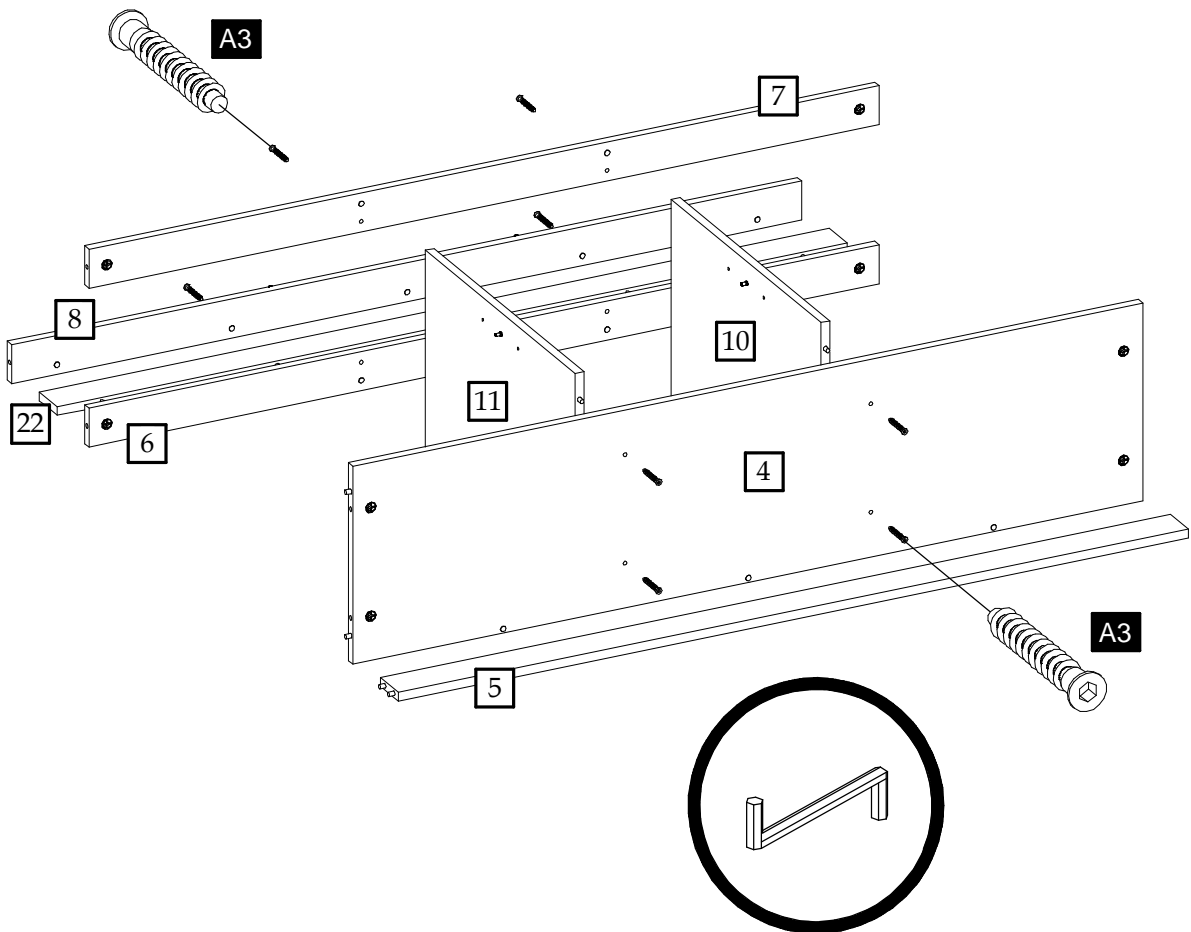

6

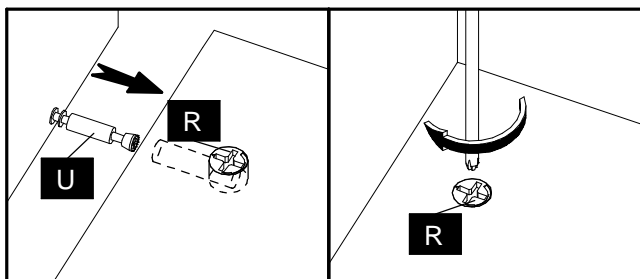
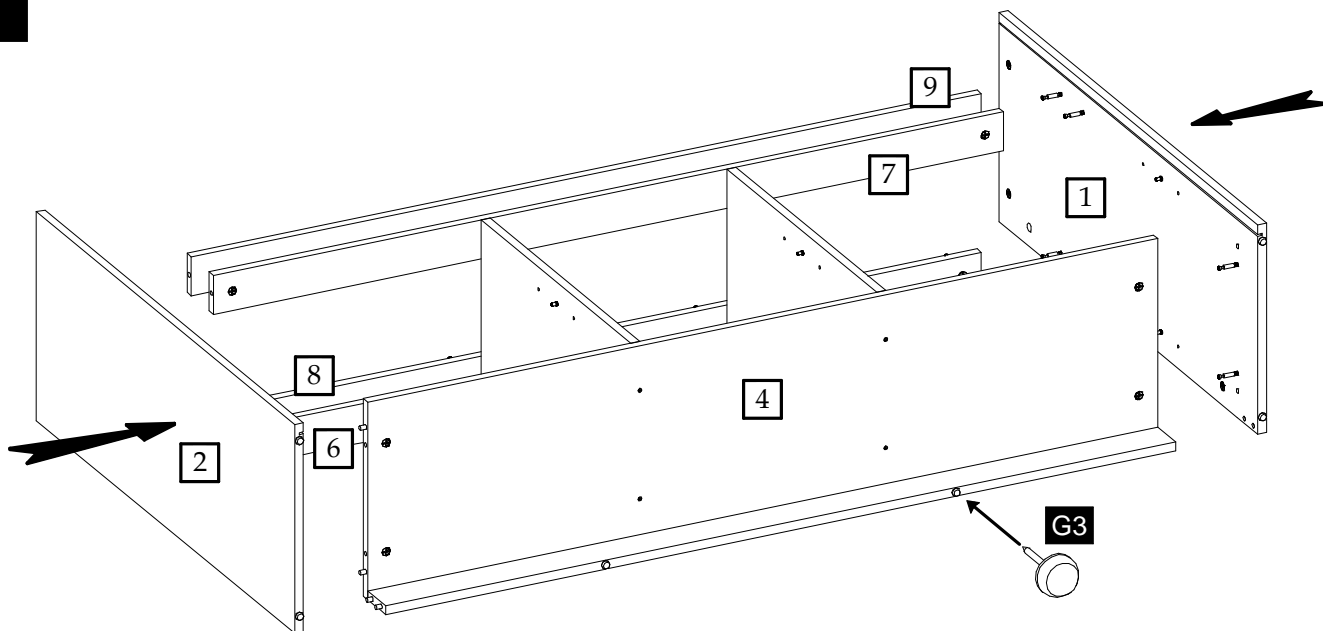

7

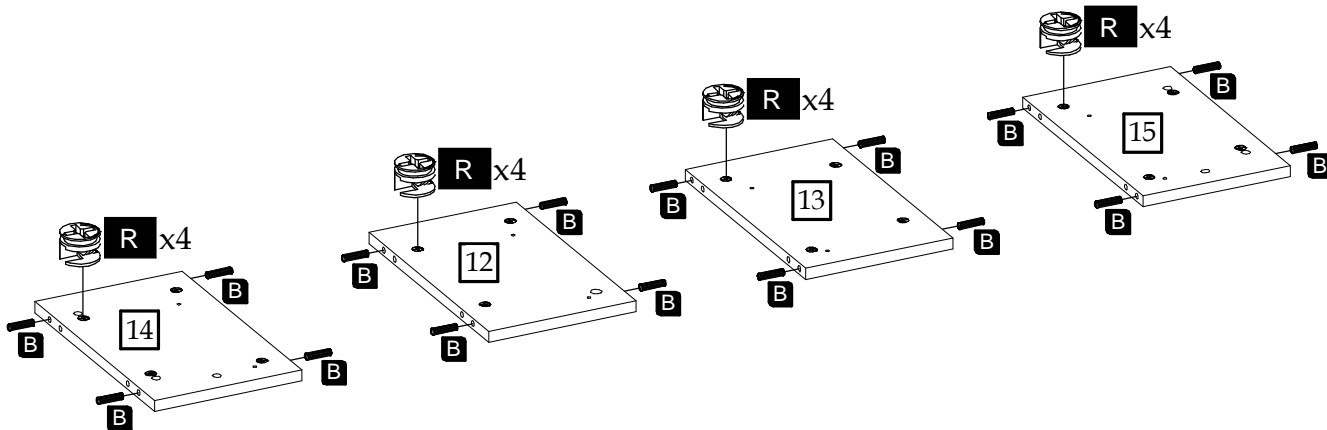



8

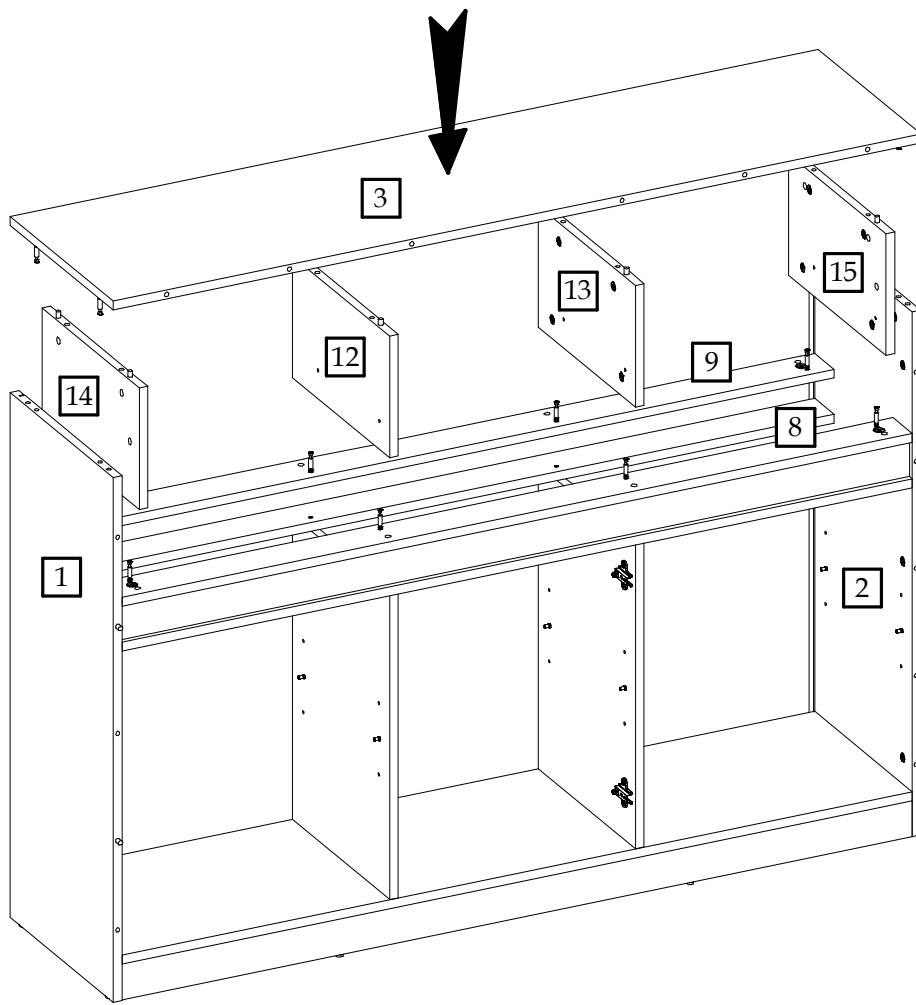

9

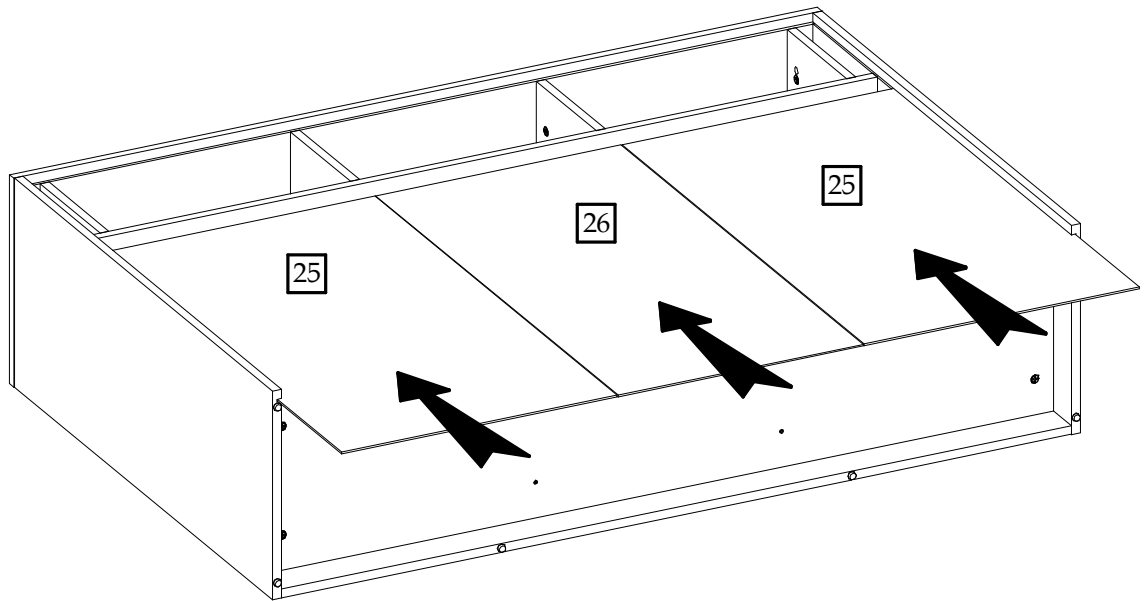

10

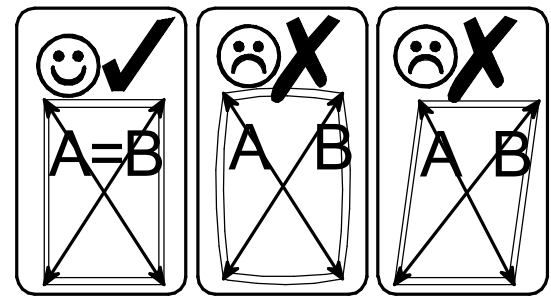
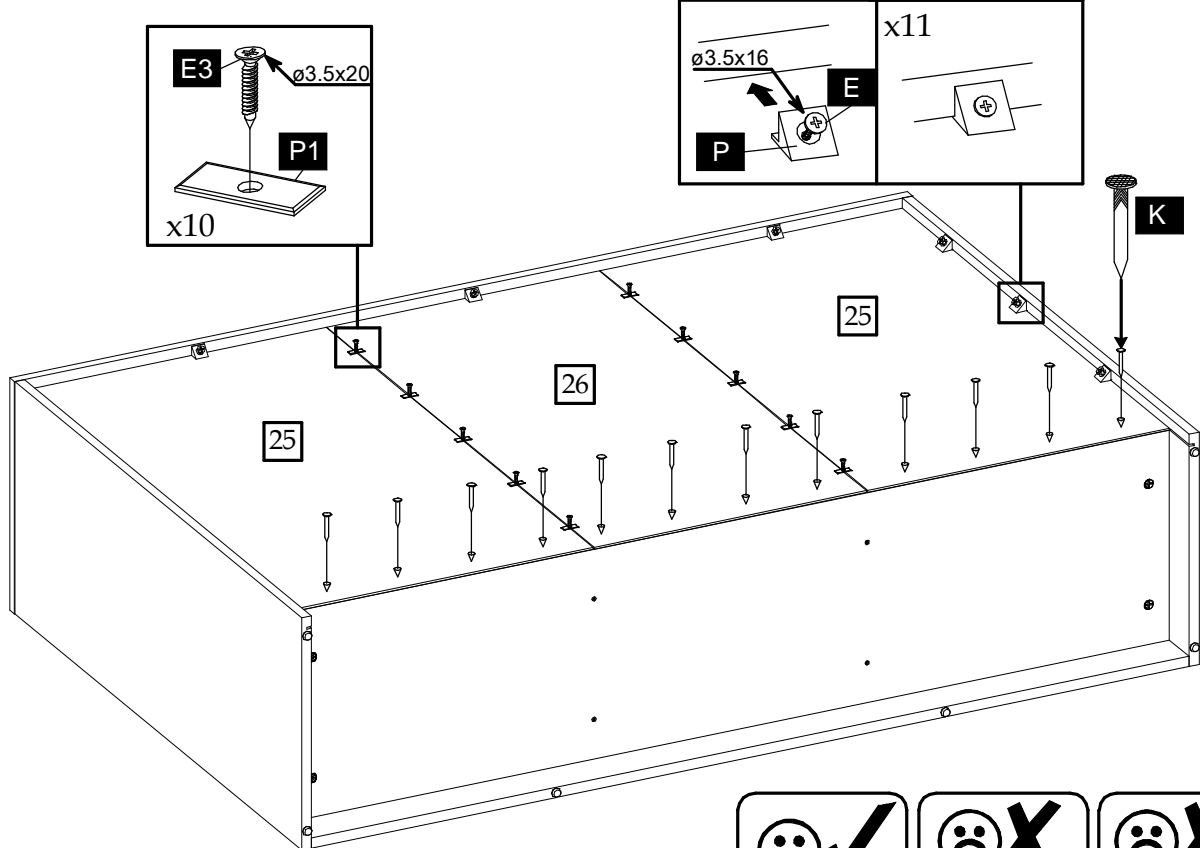

11

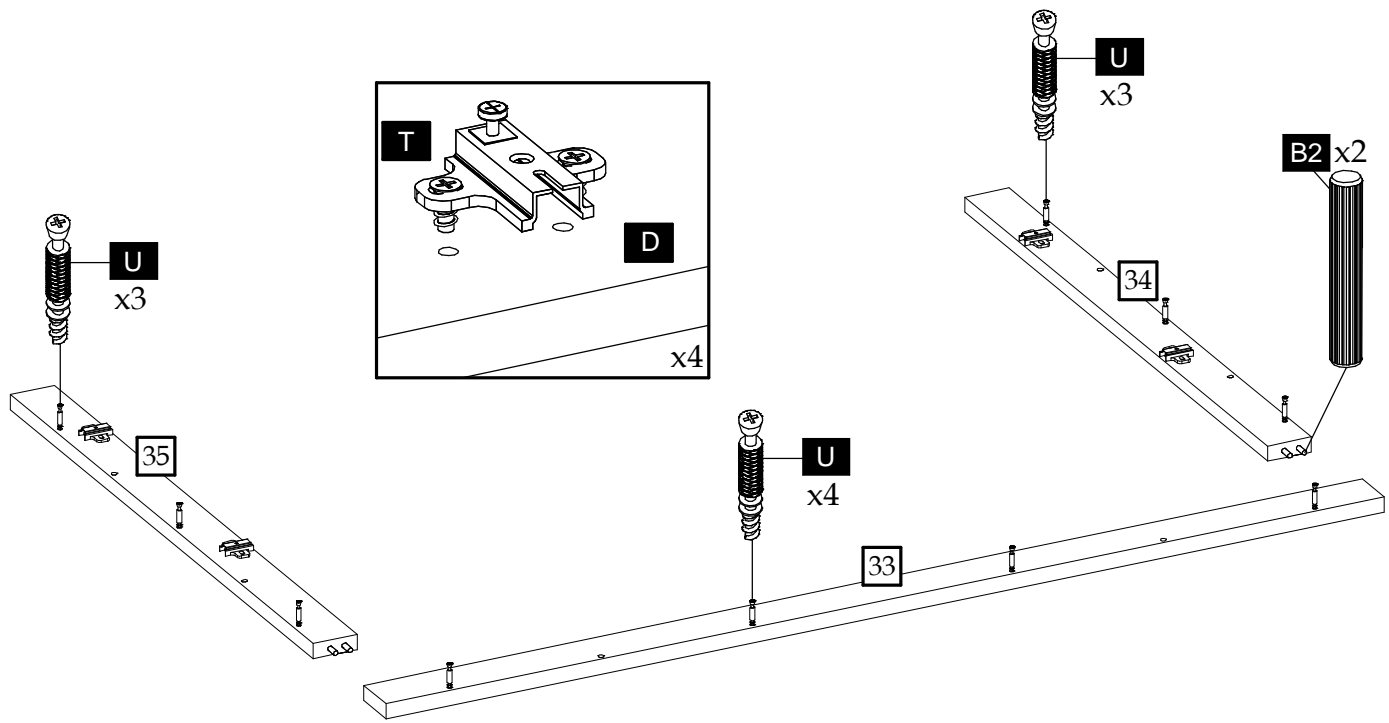

12

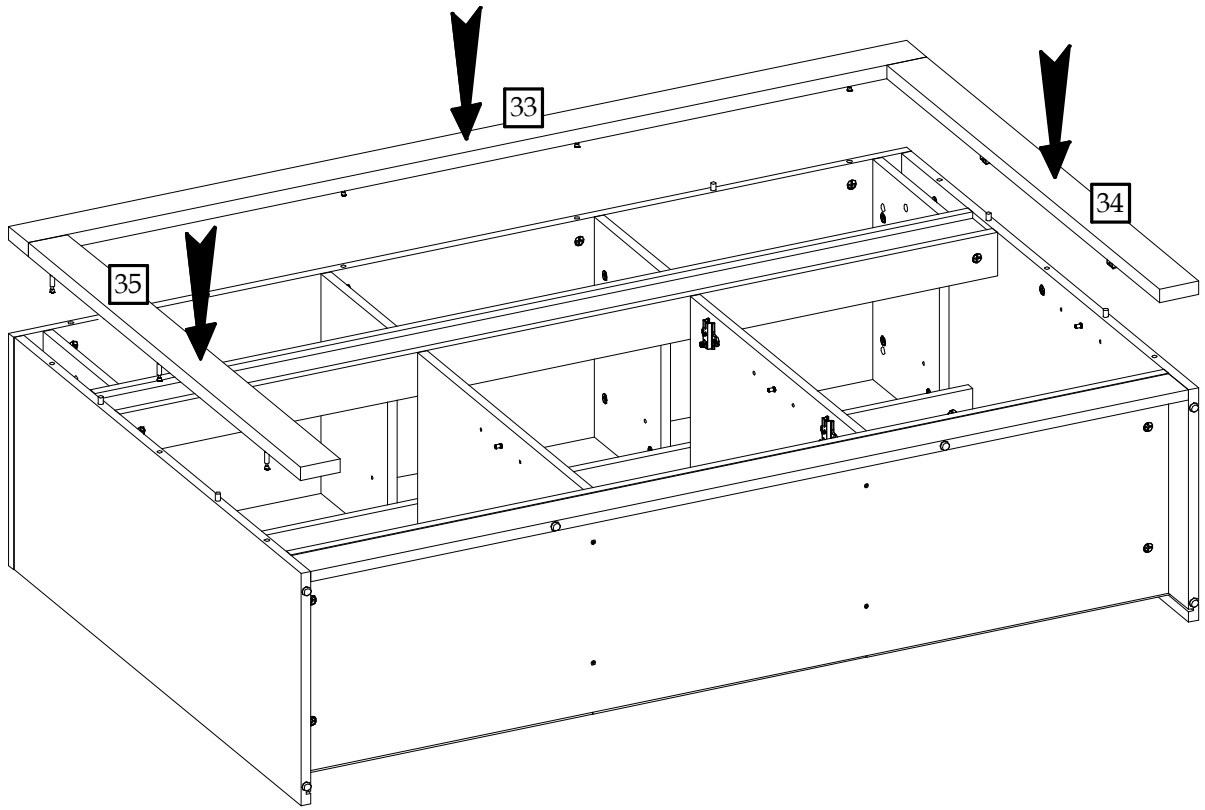

13

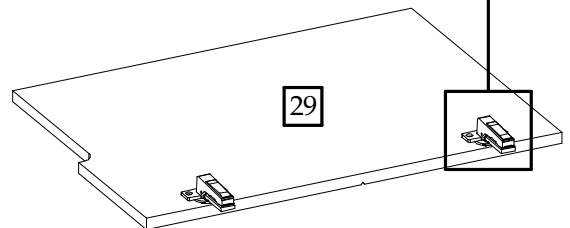
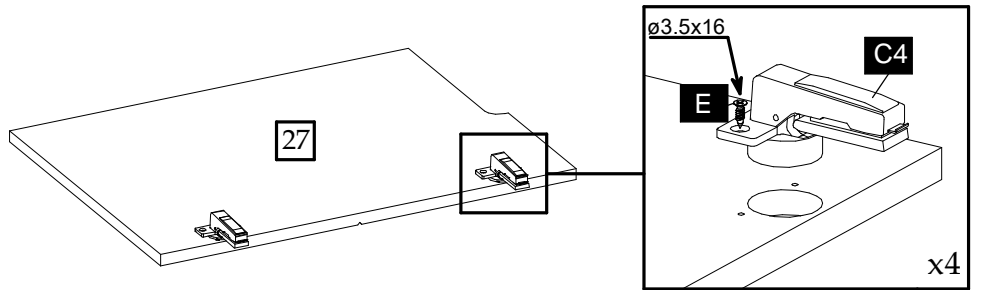
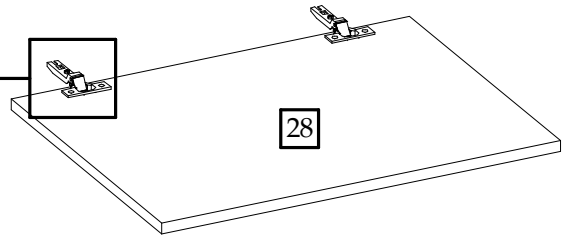
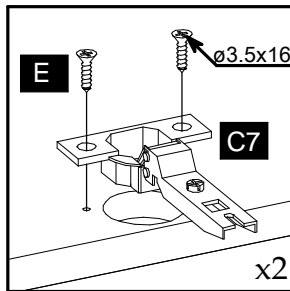

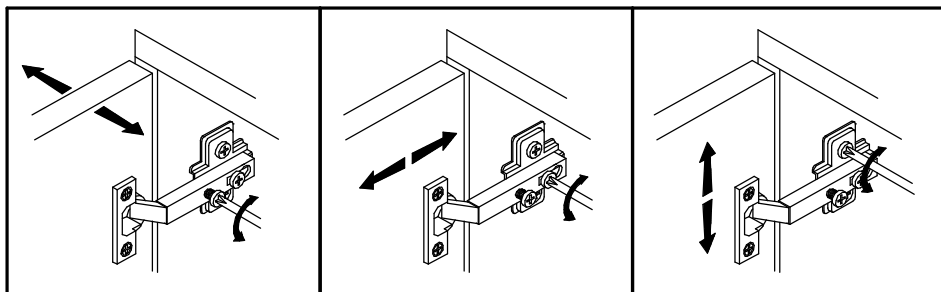
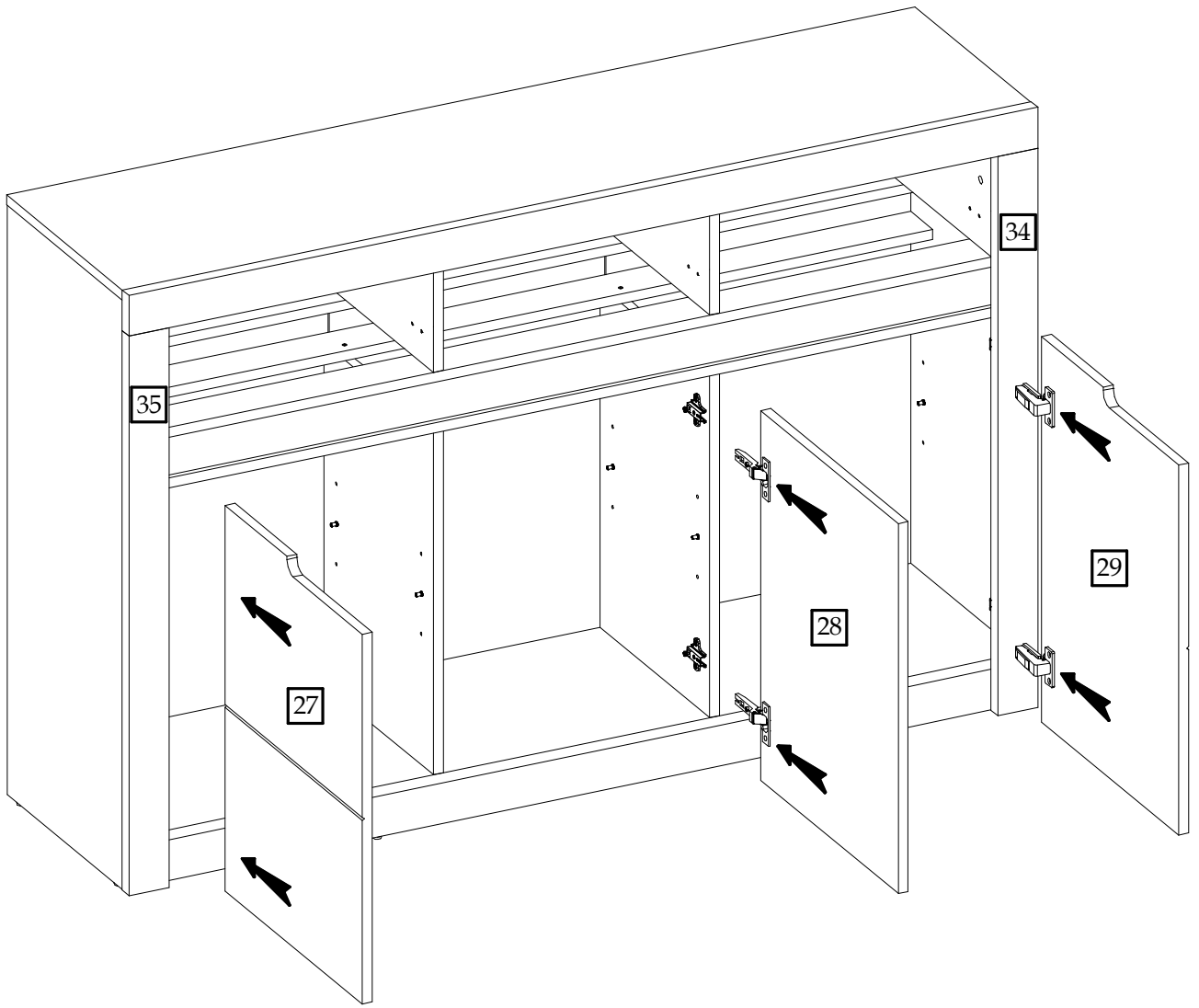

Left

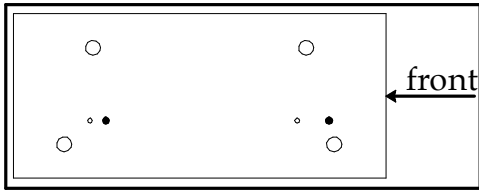

Right

