

Vincent

Typ A2

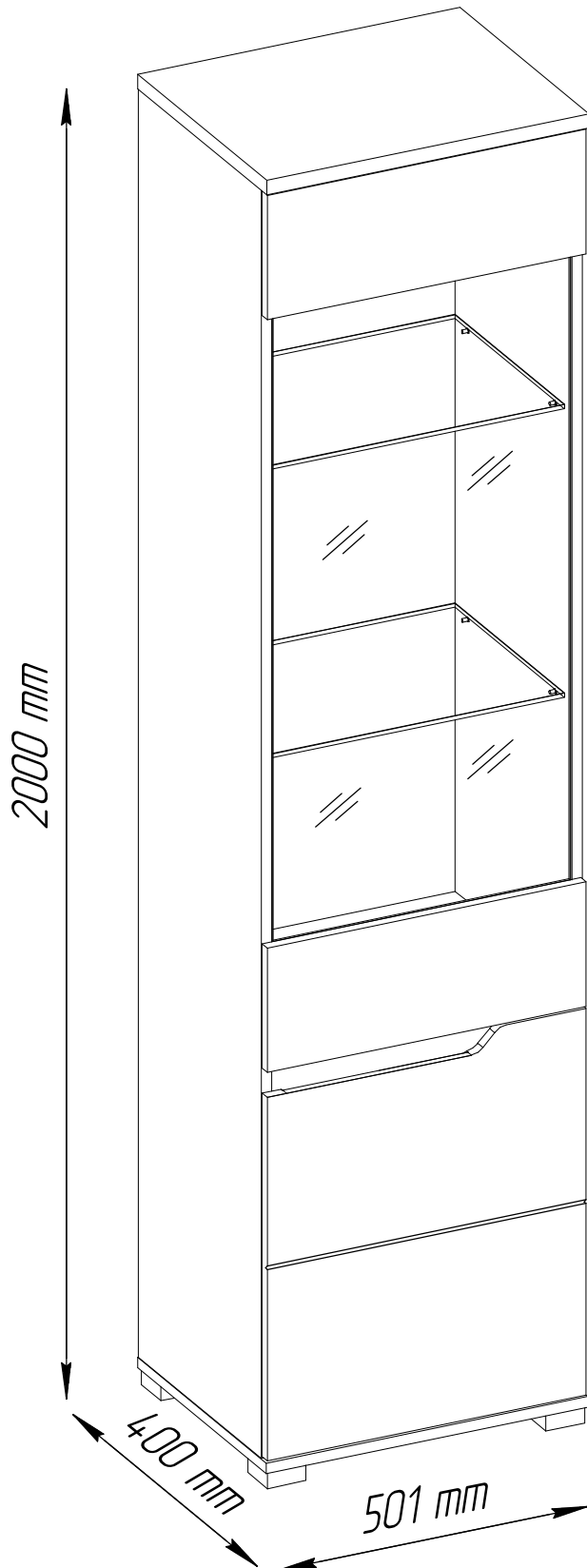

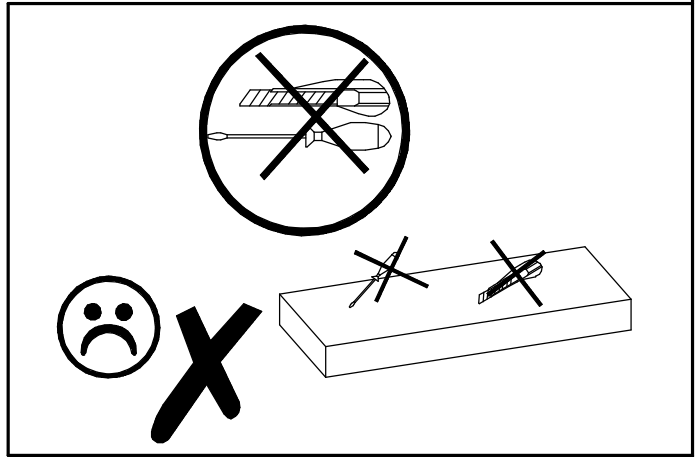

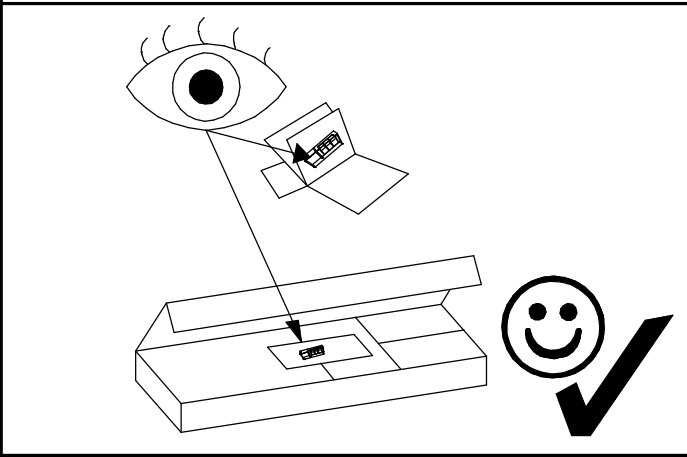
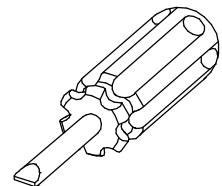
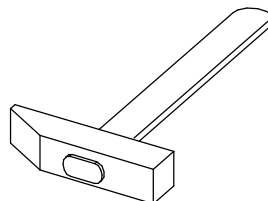
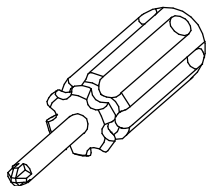
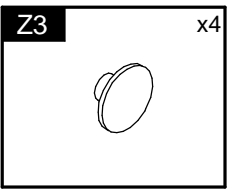
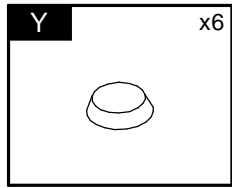
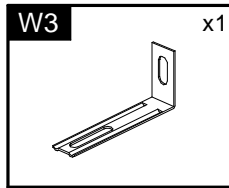
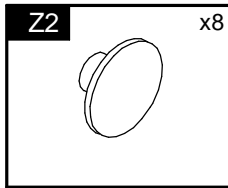
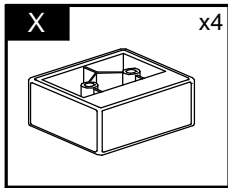
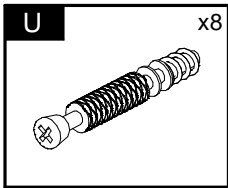
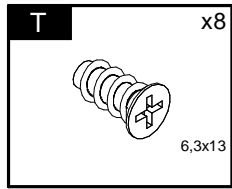
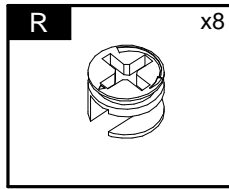
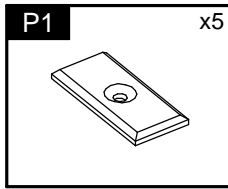
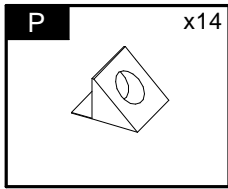
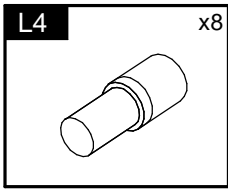
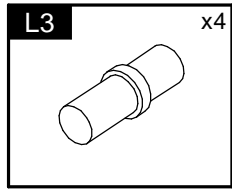
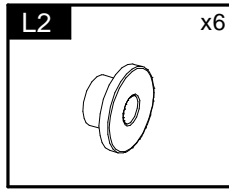
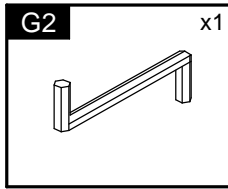
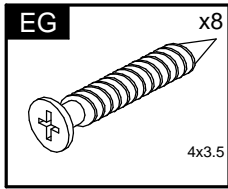
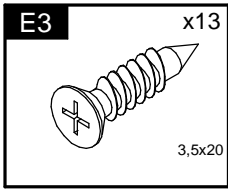
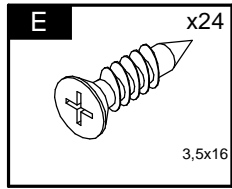
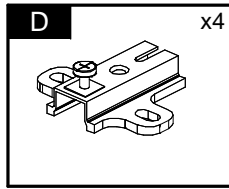
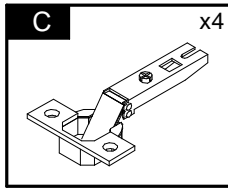
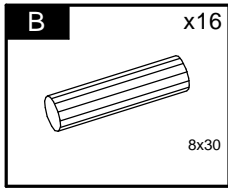
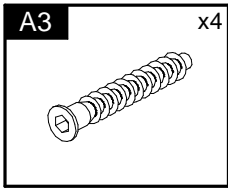
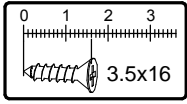

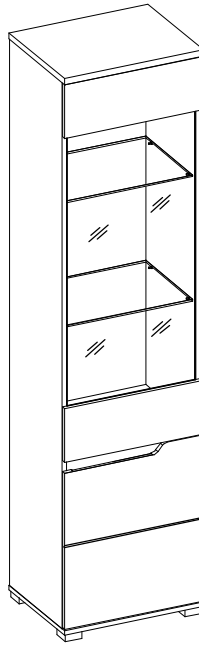

Element symbol	Measurements				Code	Paket
	W	H	T	D		
1	501	400	22	1	1004	1/3
2	501	398.5	16	1	1001	1/3
3	467	344.5	16	1	1006	1/3
4	467	77	16	1	1018	1/3
5	1937	381	16	1	1002	1/3
6	1937	381	16	1	1003	1/3
7	461	351	16	1	N/A	1/3
8	620	480	2.5	1	N/A	2/3
9	1330	480	2.5	1	N/A	1/3
10	590	496	16	1	3015	2/3
11	496	190	16	1	3021	2/3
12	496	190	16	1	3022	2/3
13	1020	463	4	1	N/A	3/3
14	466	340	6	2	N/A	3/3

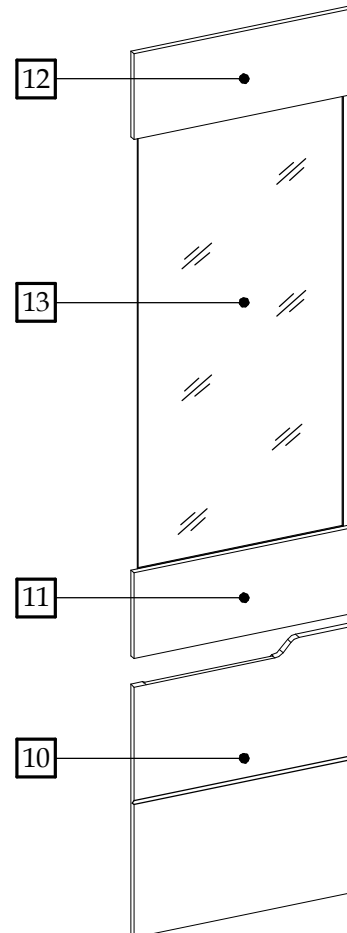
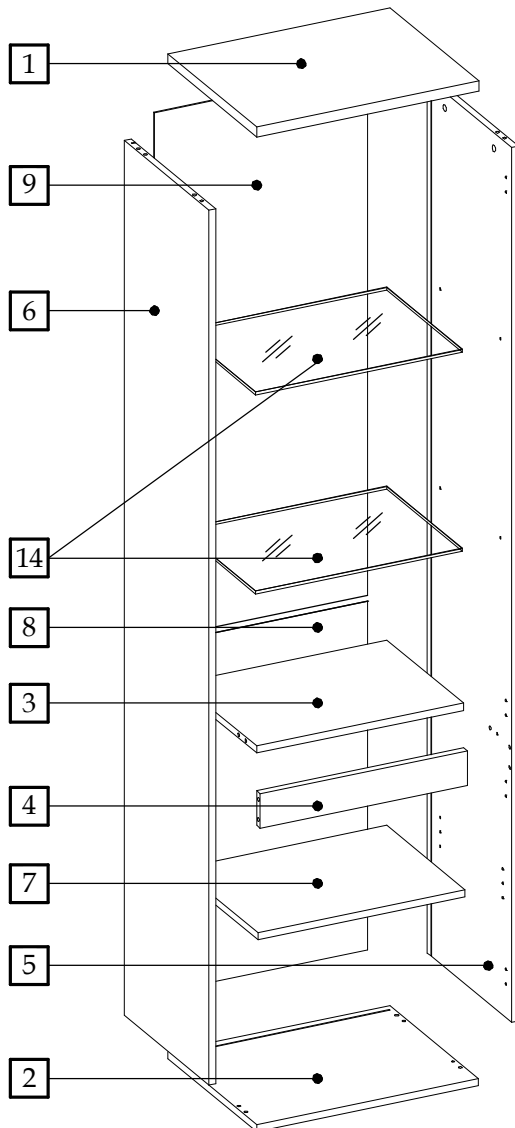

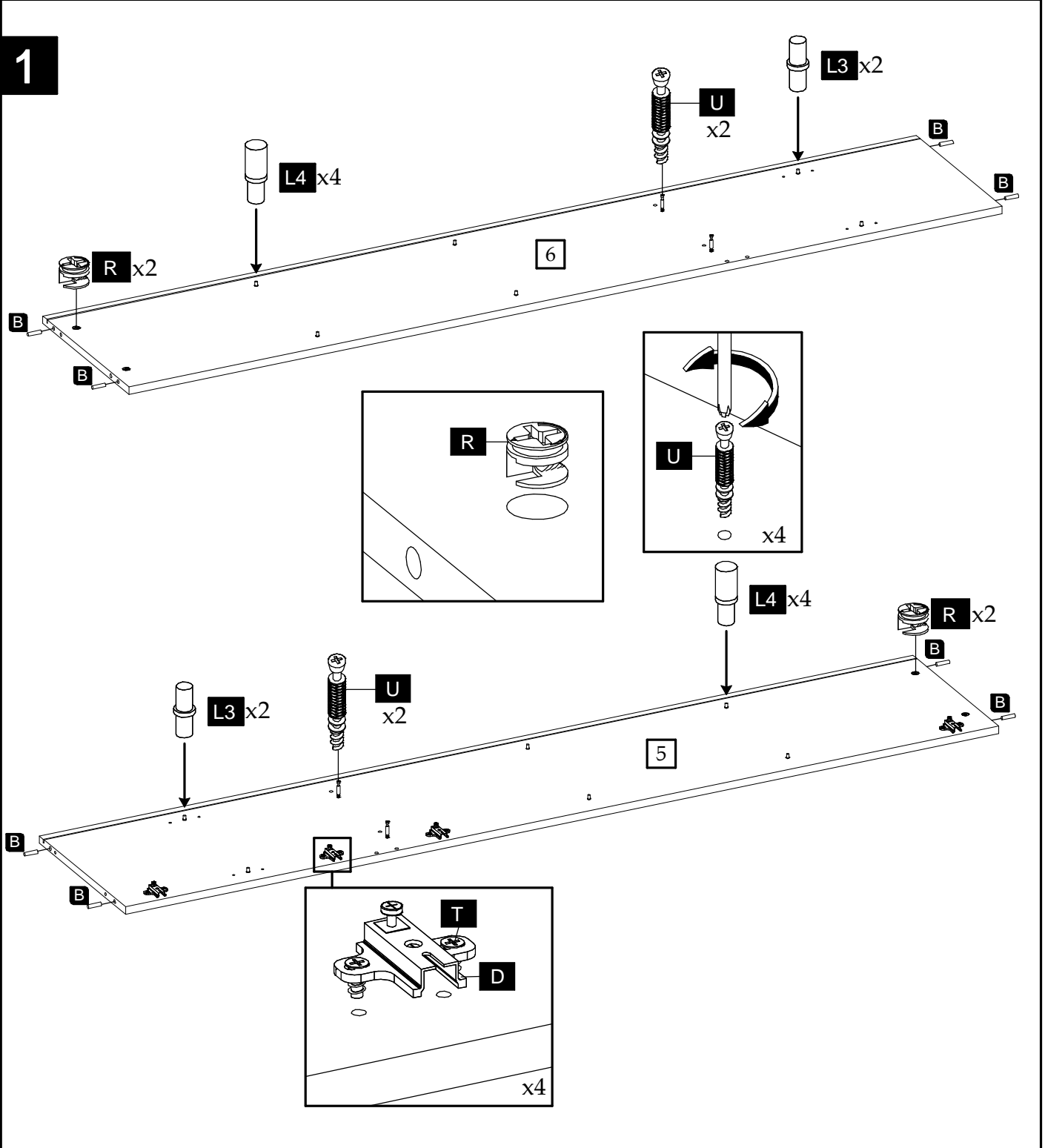

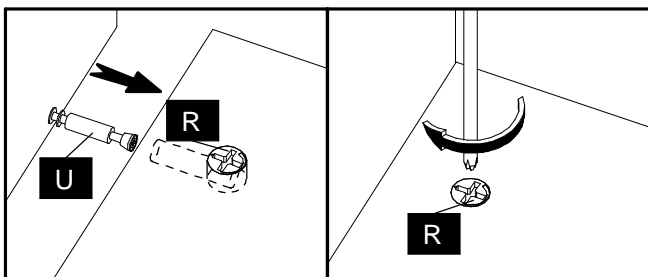
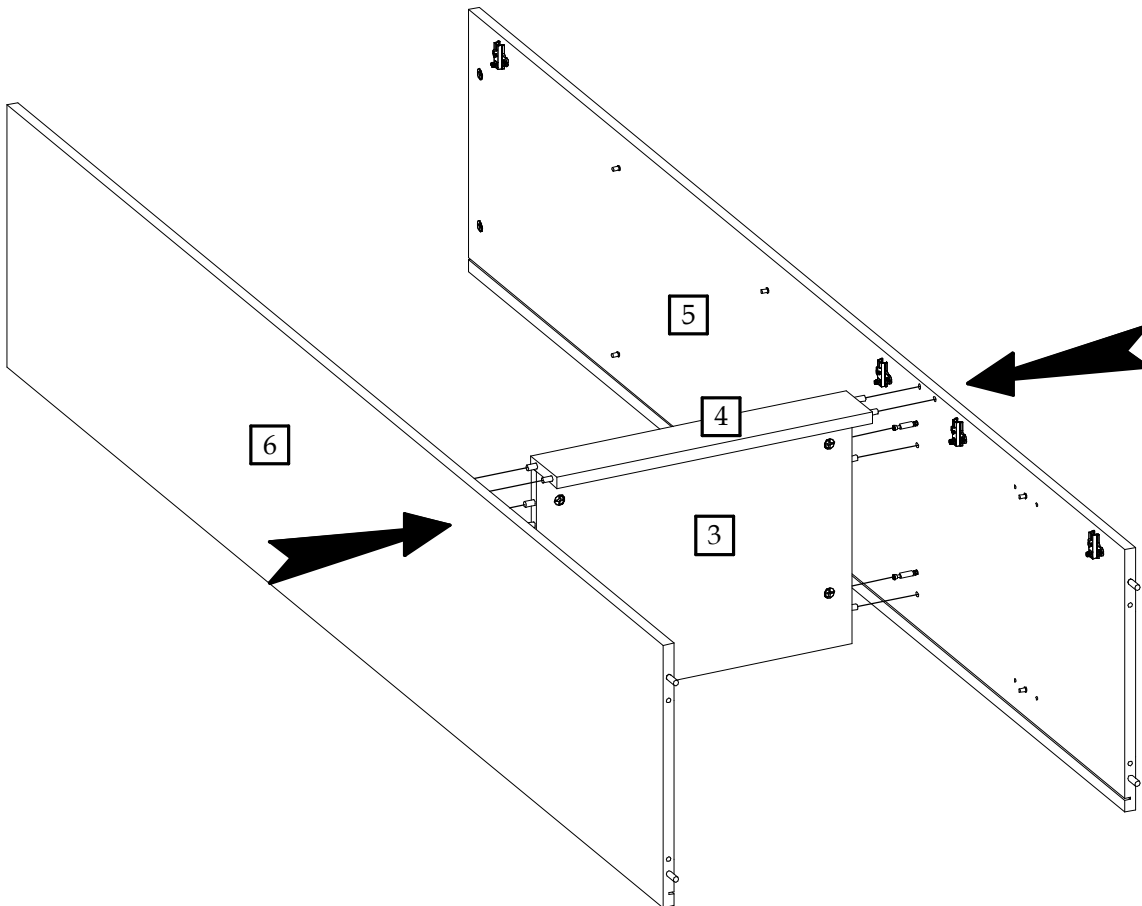
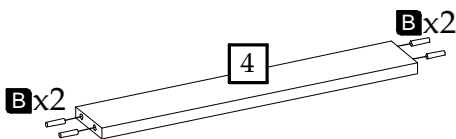
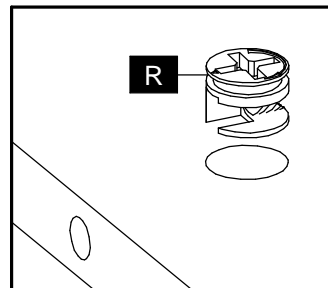
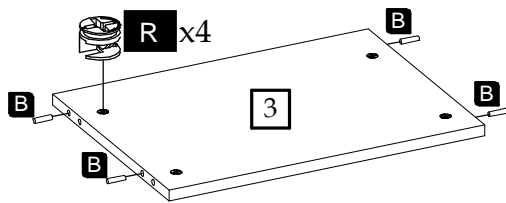

3

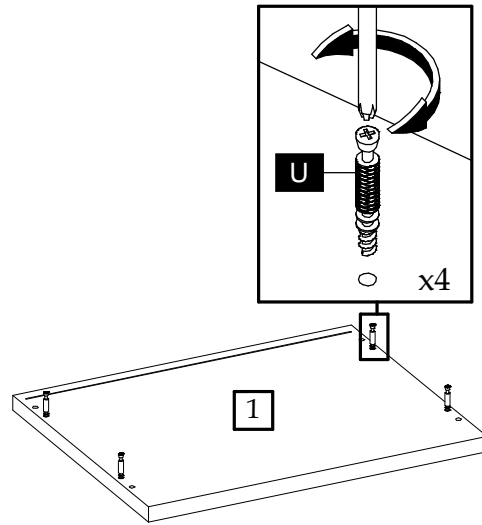
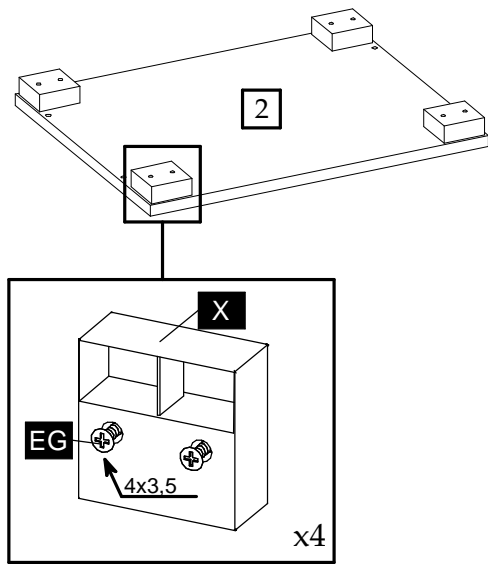

4

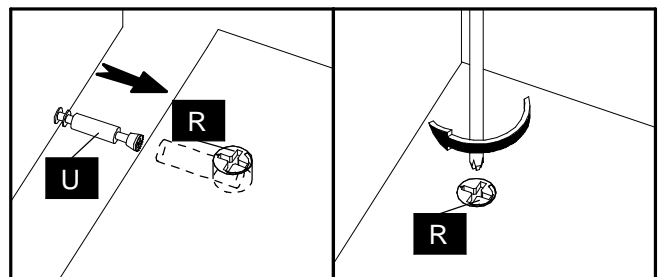
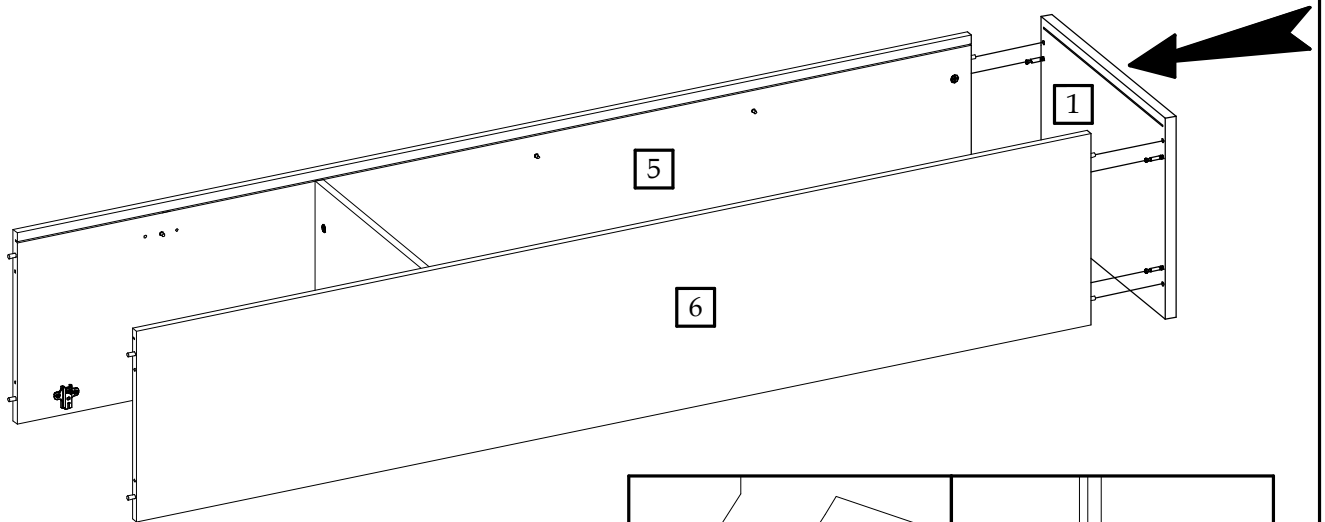

5

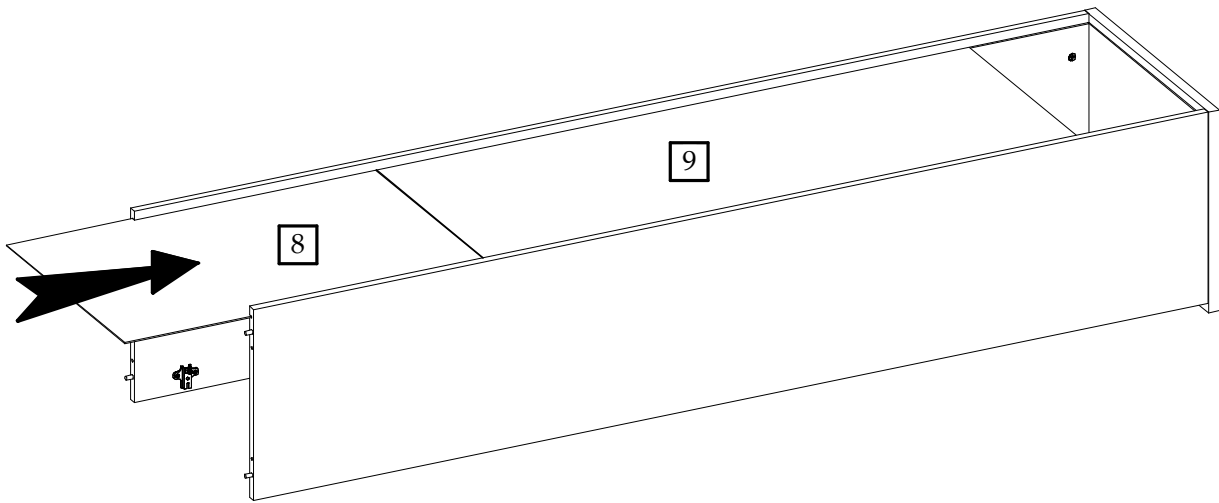

6

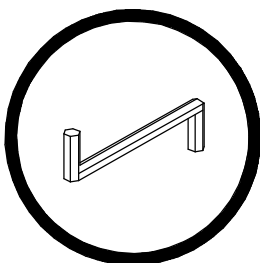
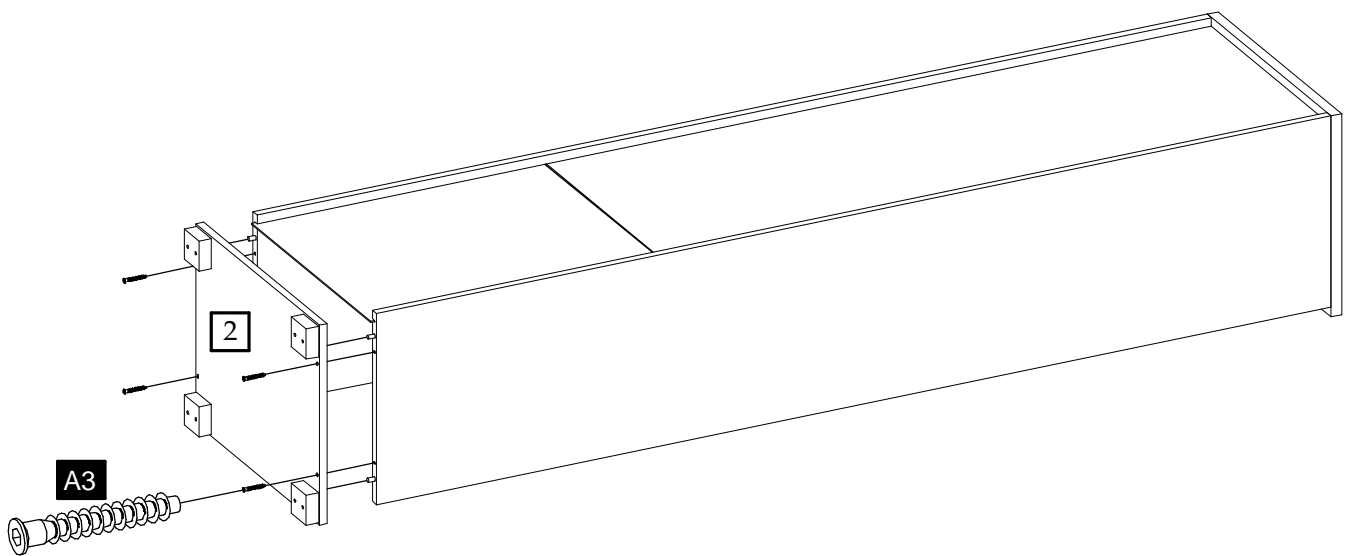

7

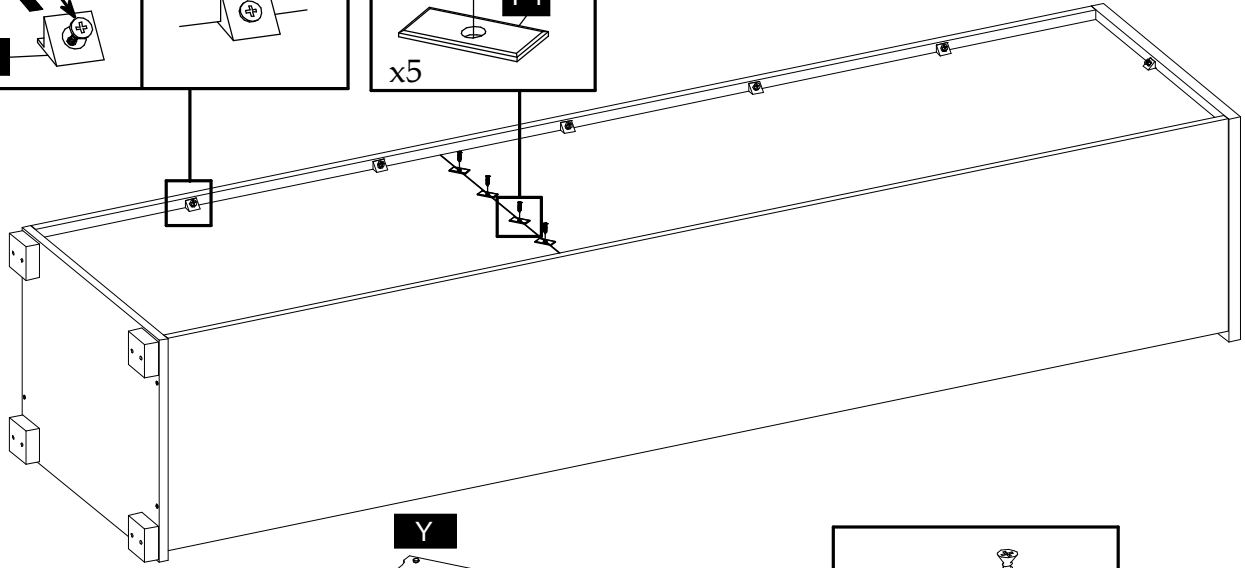
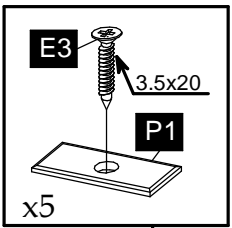
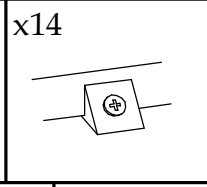
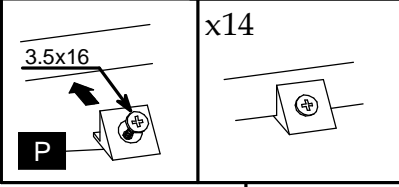
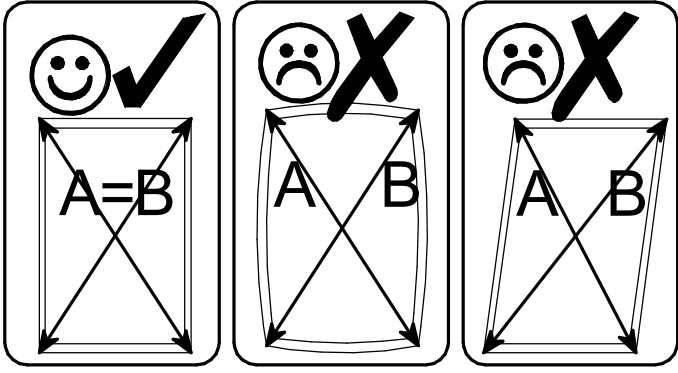
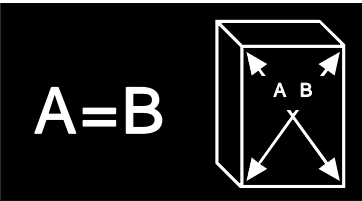

8

