

VINCENT

Typ F

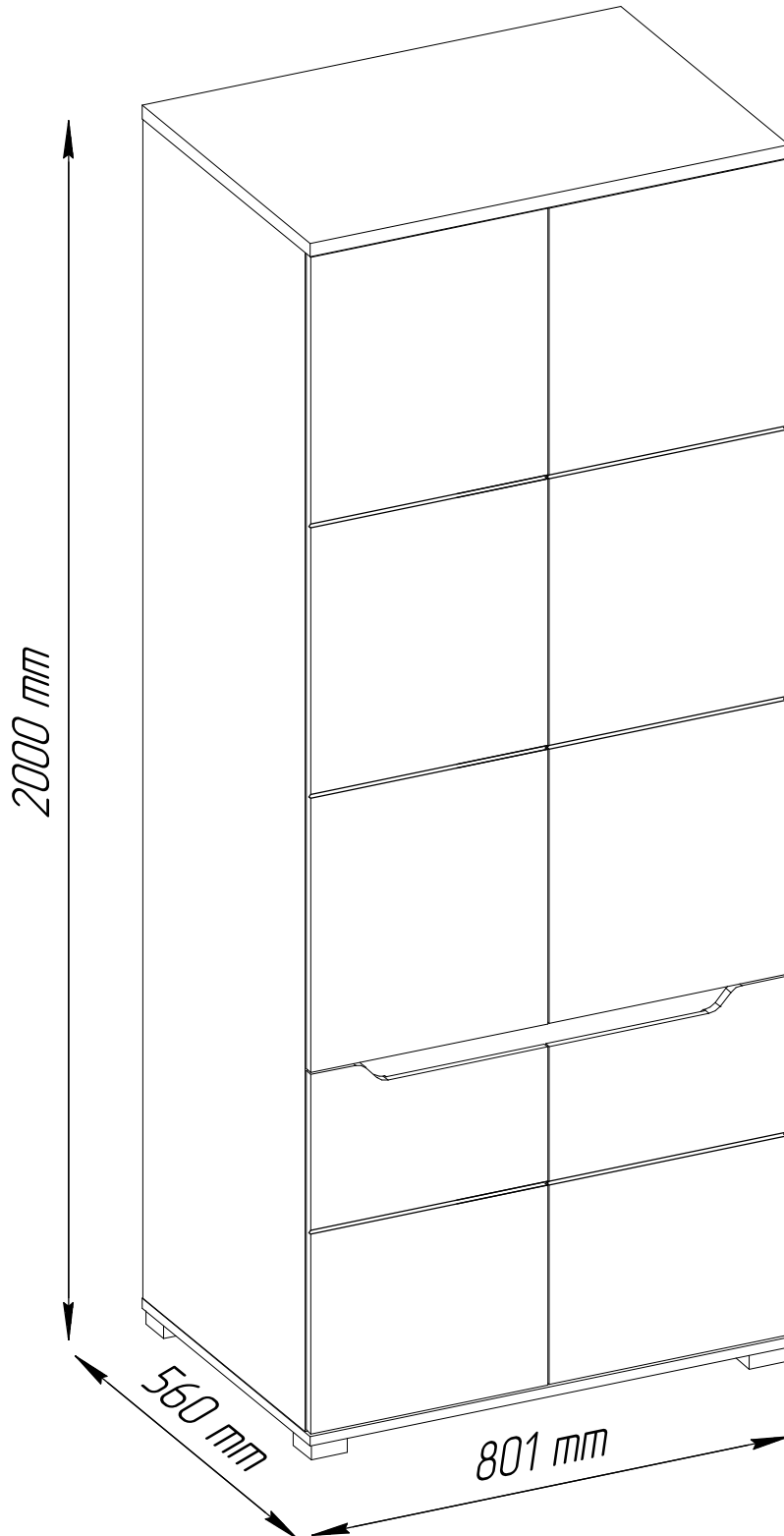

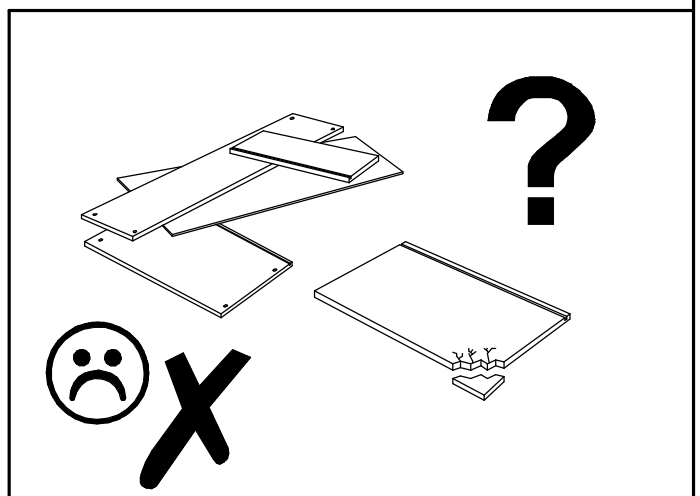

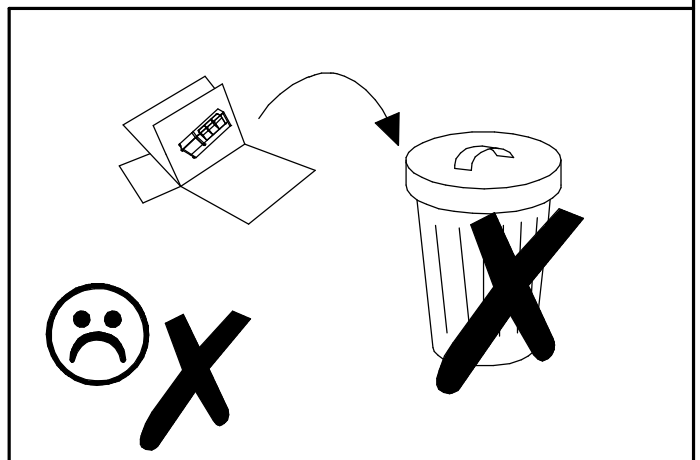
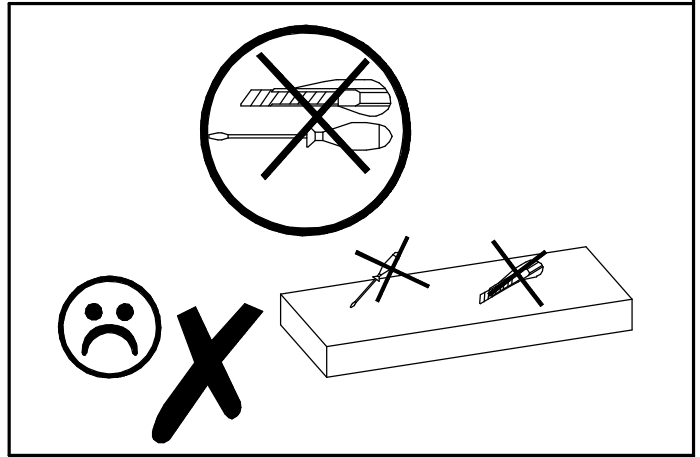
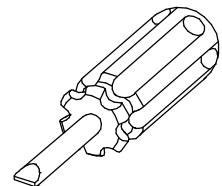
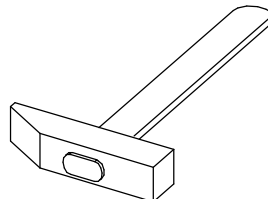
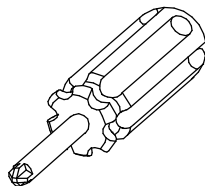
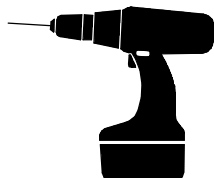
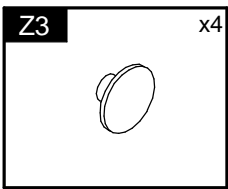
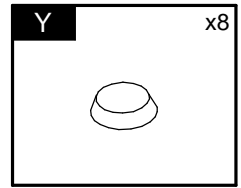
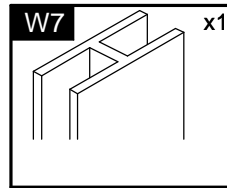
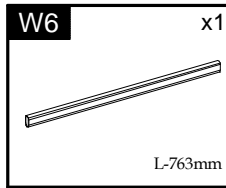
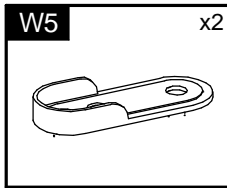
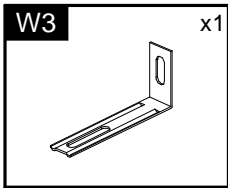
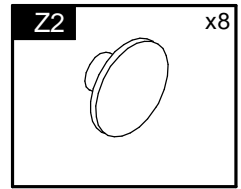
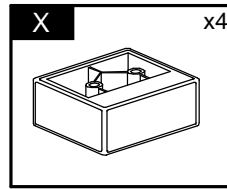
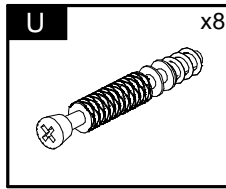
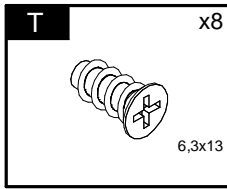
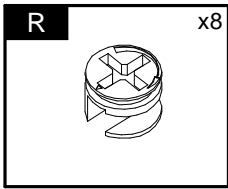
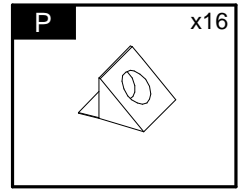
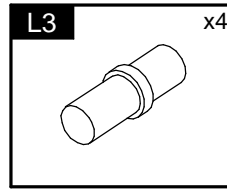
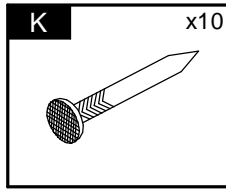
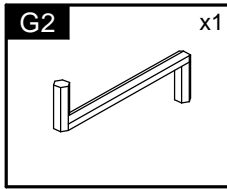
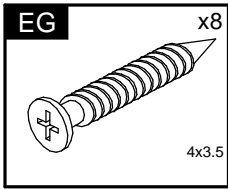
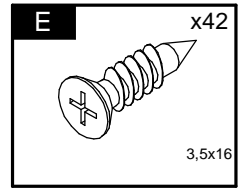
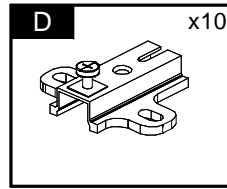
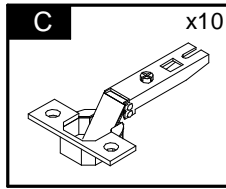
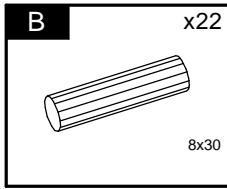
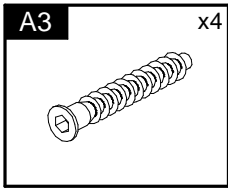
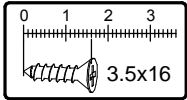

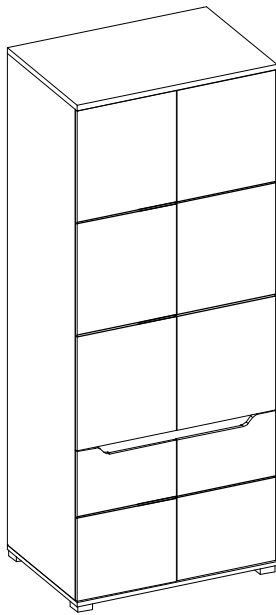

Element symbol	Measurements				Code	Paket
	W	H	T	Gr		
1	801	560	22	1	1004	1/2
2	801	558.5	16	1	1001	1/2
3	767	77	16	1	1018	1/2
4	1937	541	16	1	1002	1/2
5	1937	541	16	1	1003	1/2
6	767	504.5	16	1	1006	1/2
7	767	511	16	1	N/A	1/2
8	1951	390	2.5	2	N/A	1/2
9	590	396	16	1	3015	2/2
10	590	396	16	1	3016	2/2
11	1339	396	16	1	3017	2/2
12	1339	396	16	1	3018	2/2

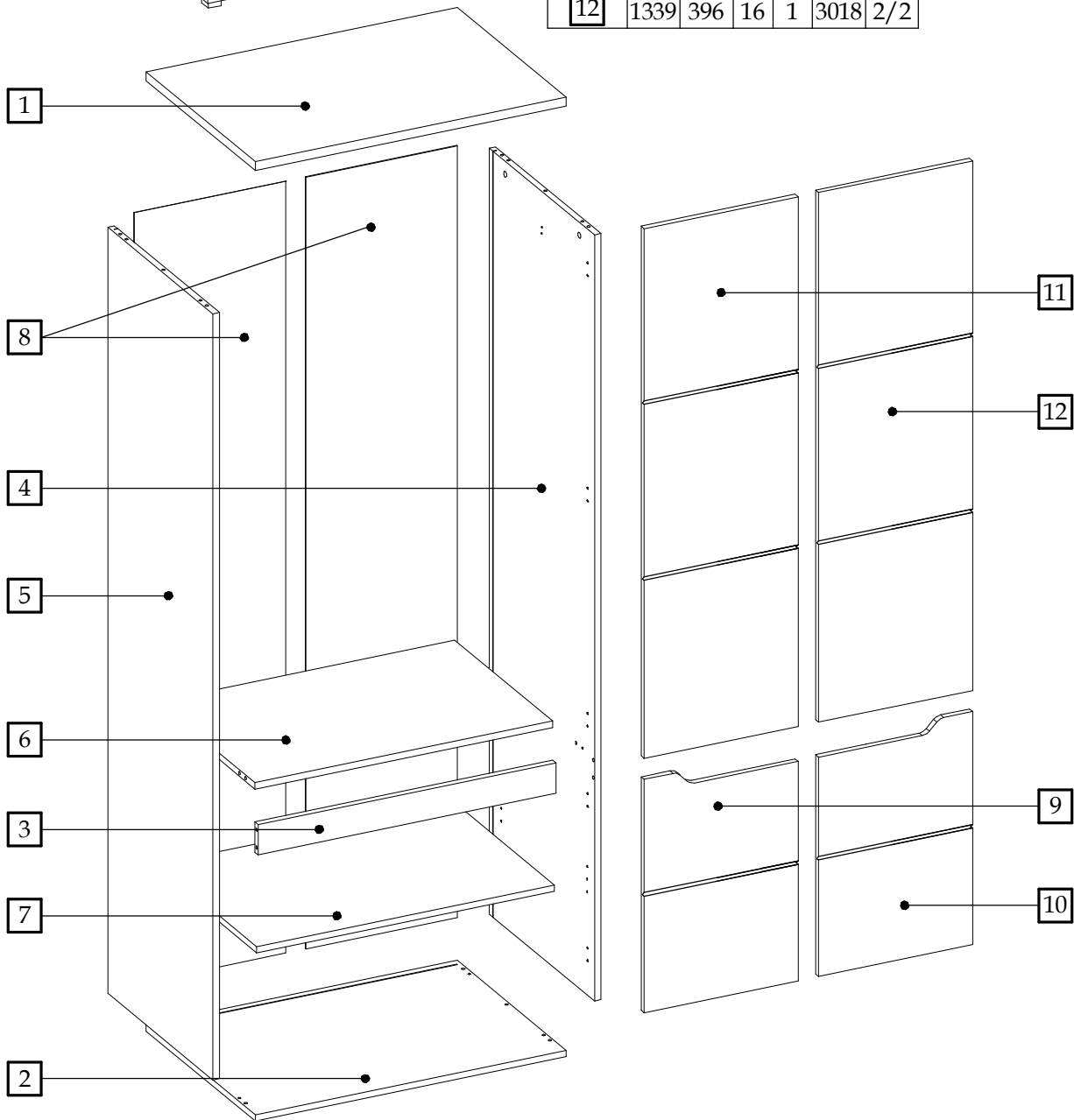

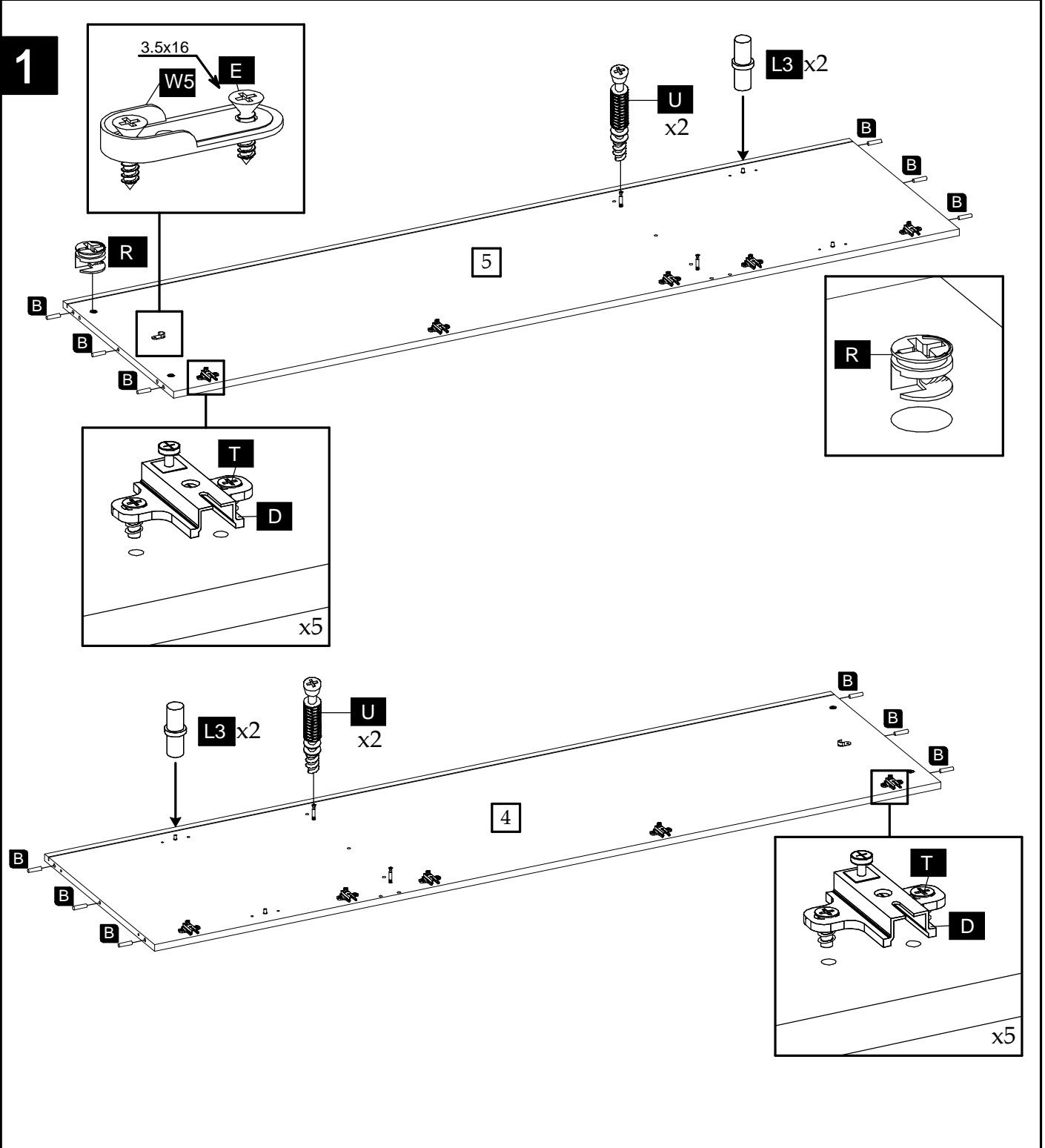

2

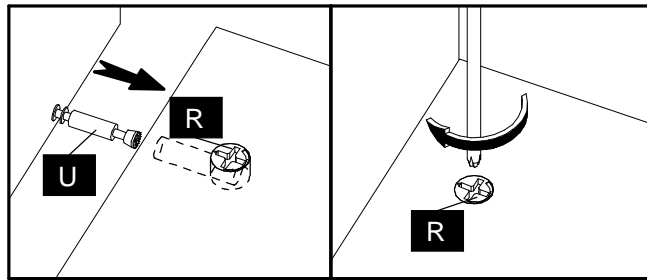
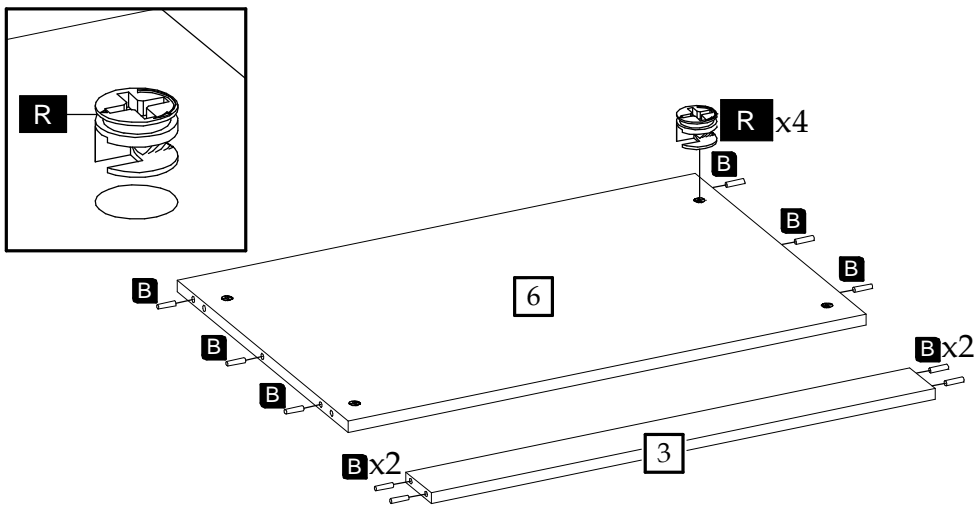

3

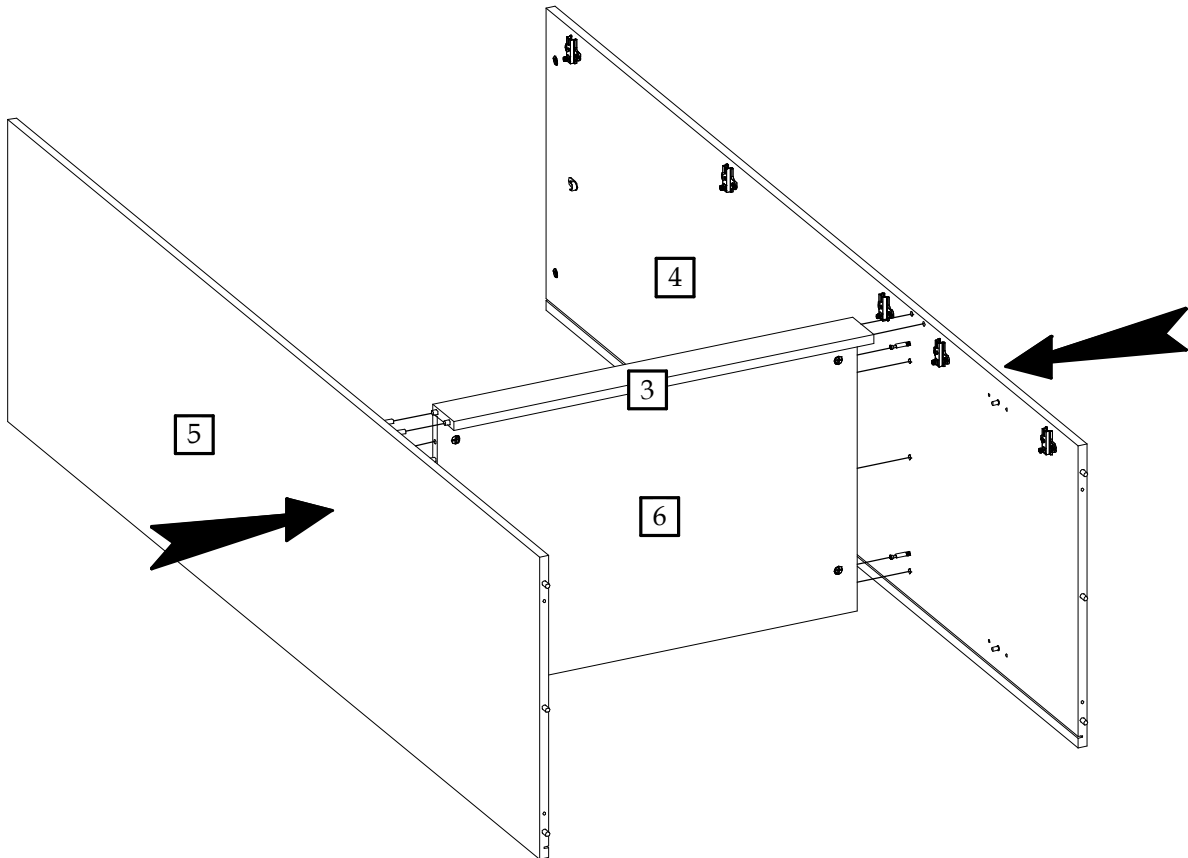

4

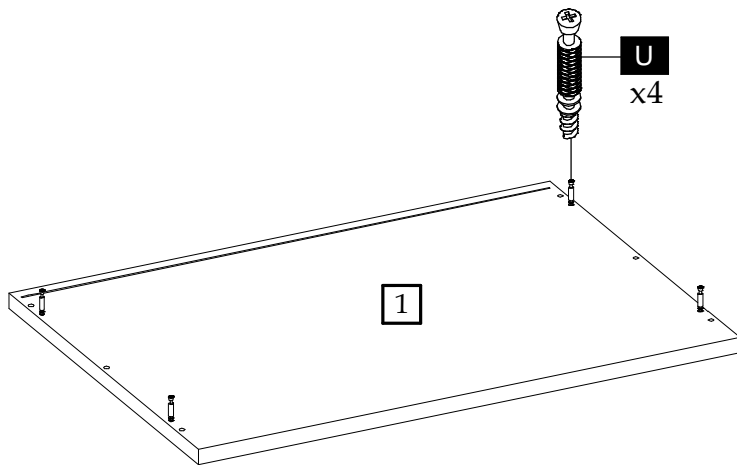

5

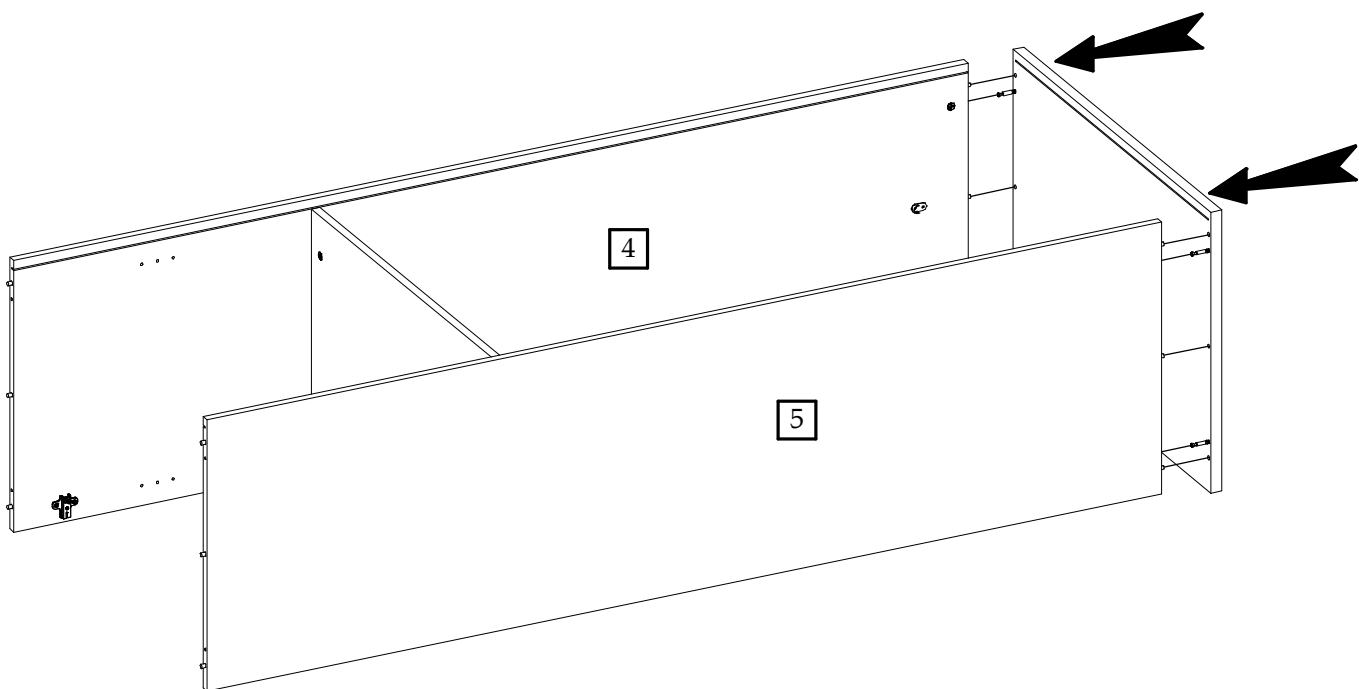

6

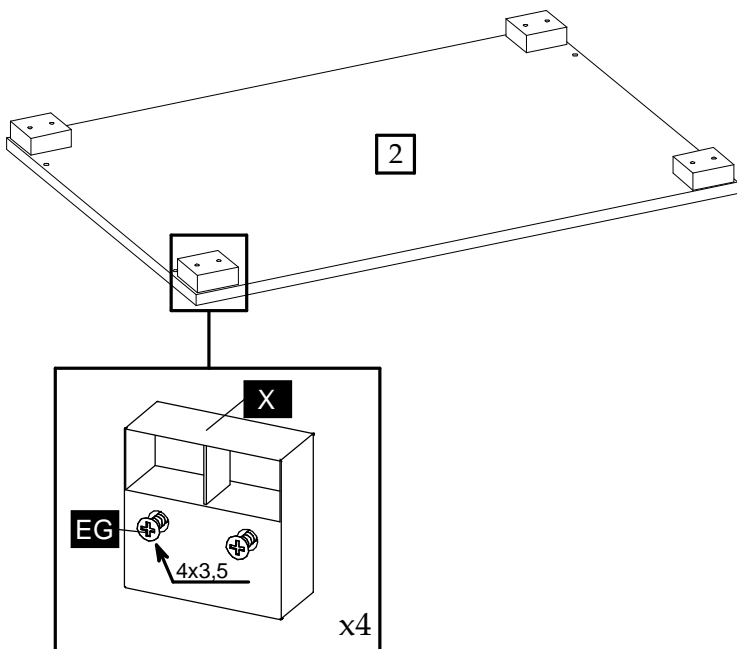

7

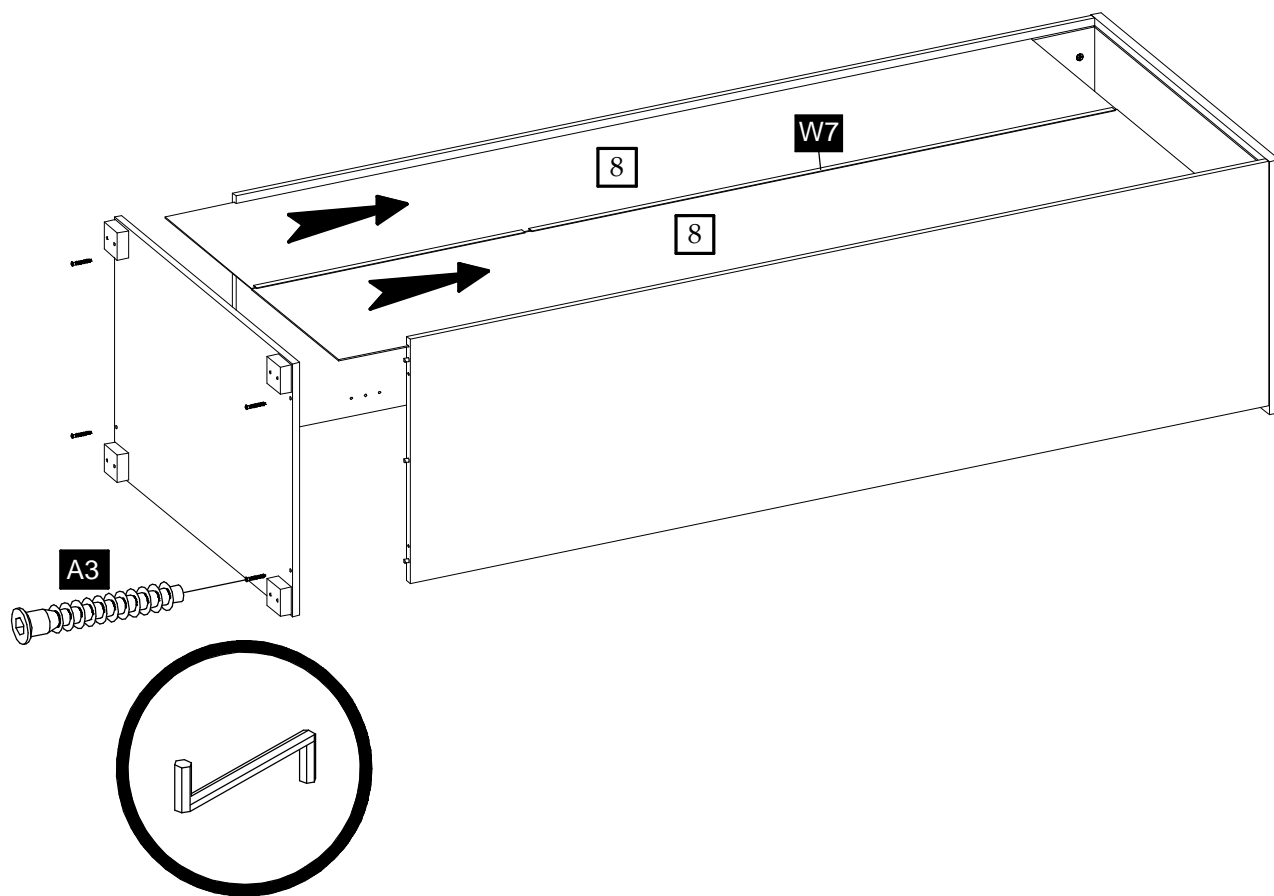

8

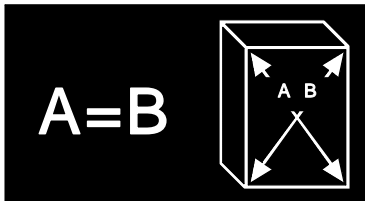

K x10

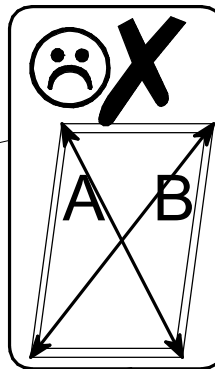
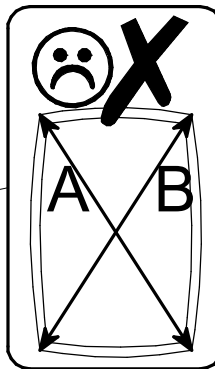
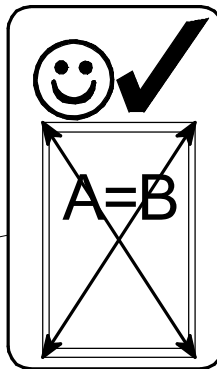
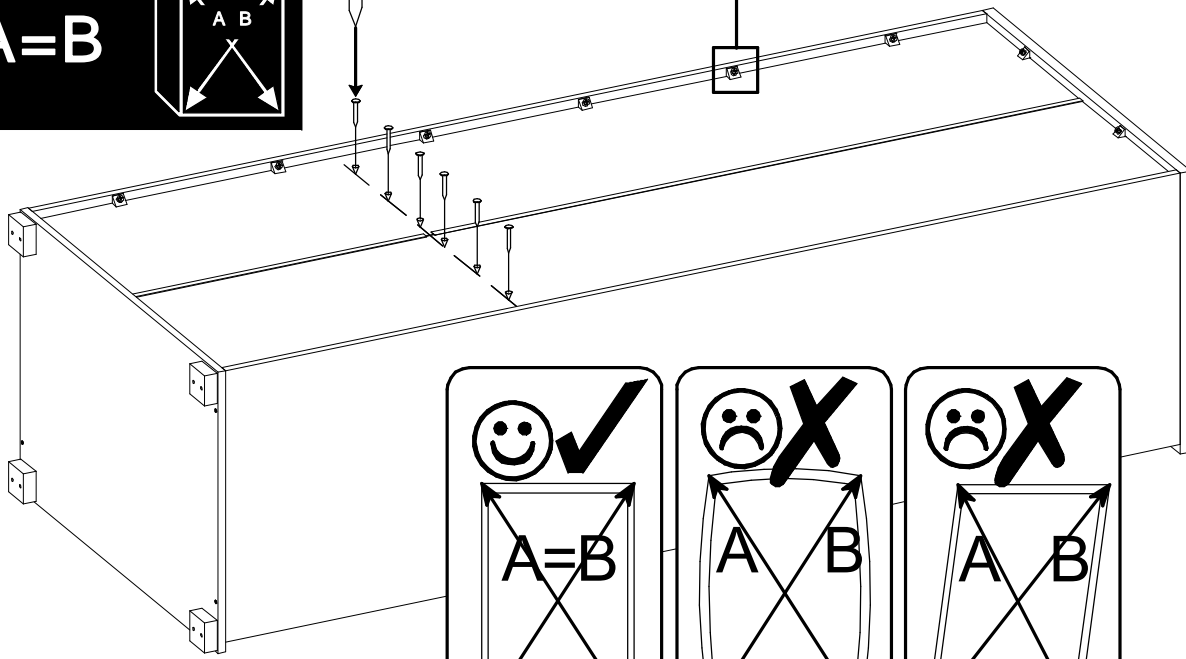
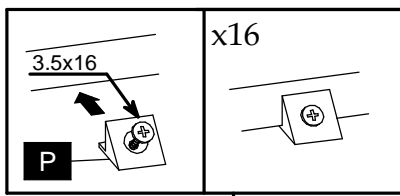

9

