

VALLES

Typ C

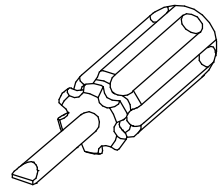

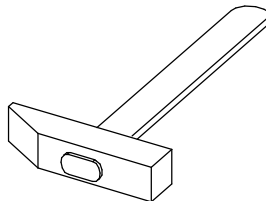

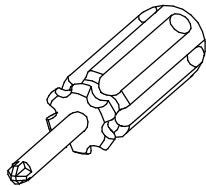
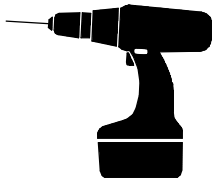
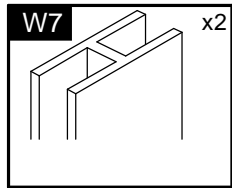
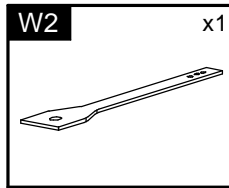
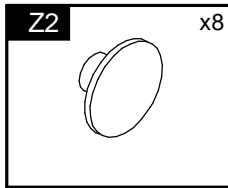
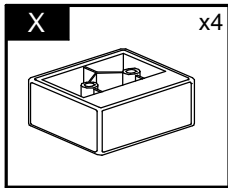
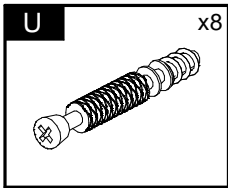
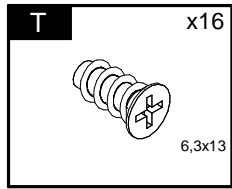
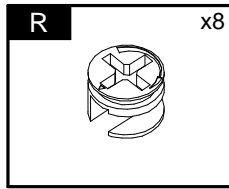
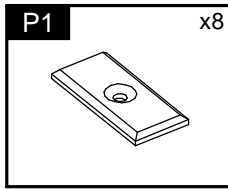
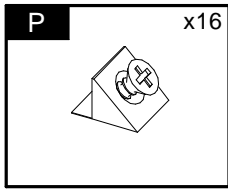
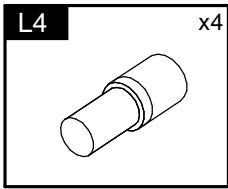
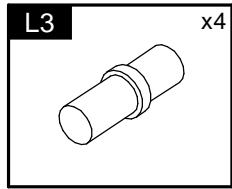
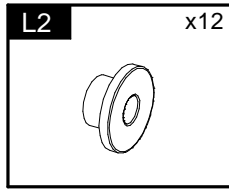
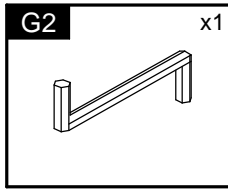
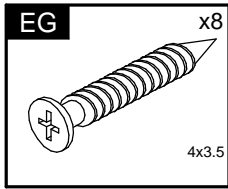
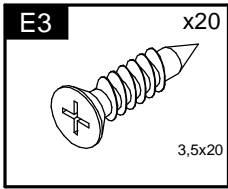
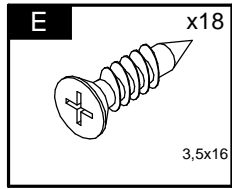
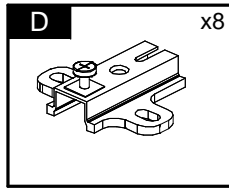
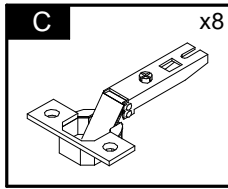
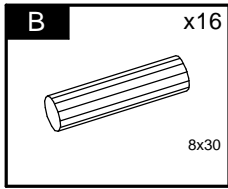
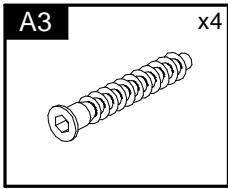

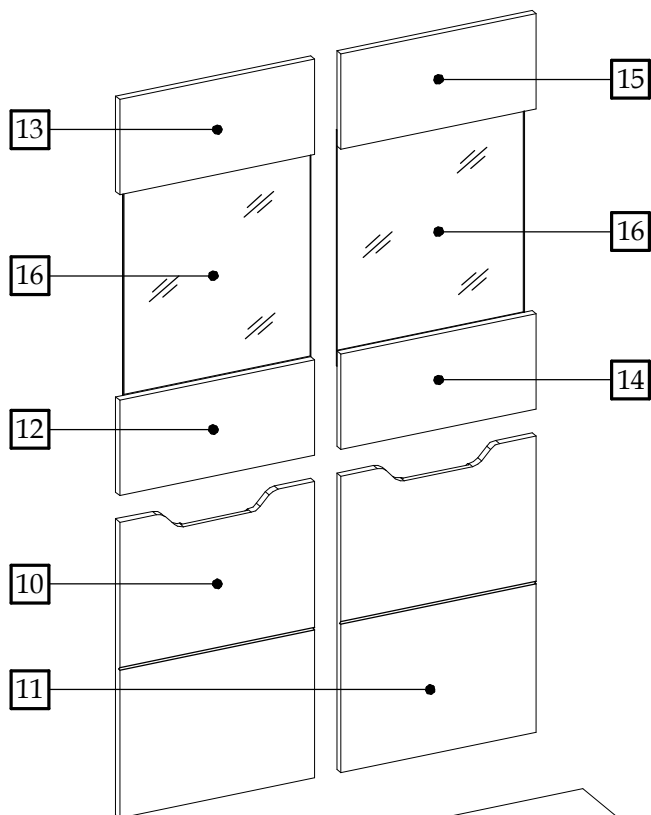

Element symbol	Measurements				Code	Paket
	W	G	T	W		
1	800	400	22	1	1004	1/3
2	800	398.5	16	1	1001	1/3
3	766	344.5	16	1	1006	1/3
4	766	77	16	1	1018	1/3
5	1387	381	16	1	1002	1/3
6	1387	381	16	1	1003	1/3
7	766	351	16	1	N/A	1/3
8	780	390	2.5	2	N/A	1/3
9	780	309	2.5	2	N/A	1/3
10	590	396	16	1	3015	2/3
11	590	396	16	1	3016	2/3
12	396	190	16	1	3021	2/3
13	396	190	16	1	3022	2/3
14	396	190	16	1	3023	2/3
15	396	190	16	1	3024	2/3
16	470	380	4	2	N/A	3/3
17	765	340	6	1	N/A	3/3

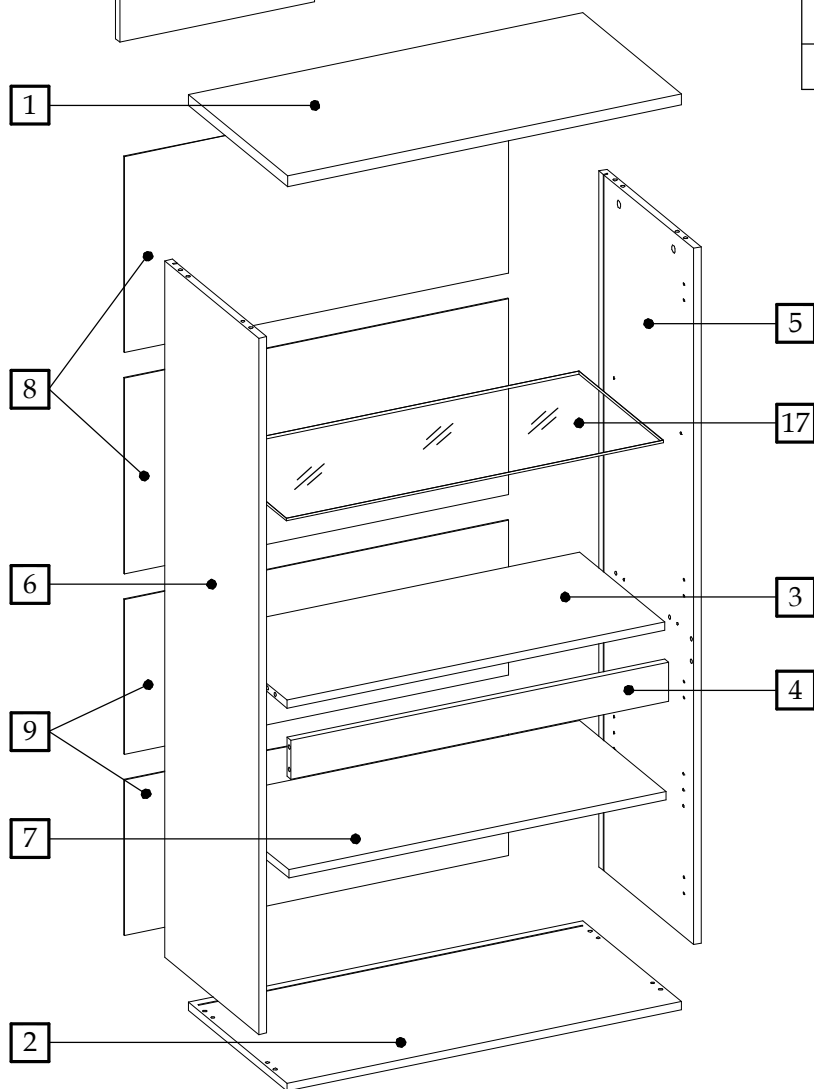



1

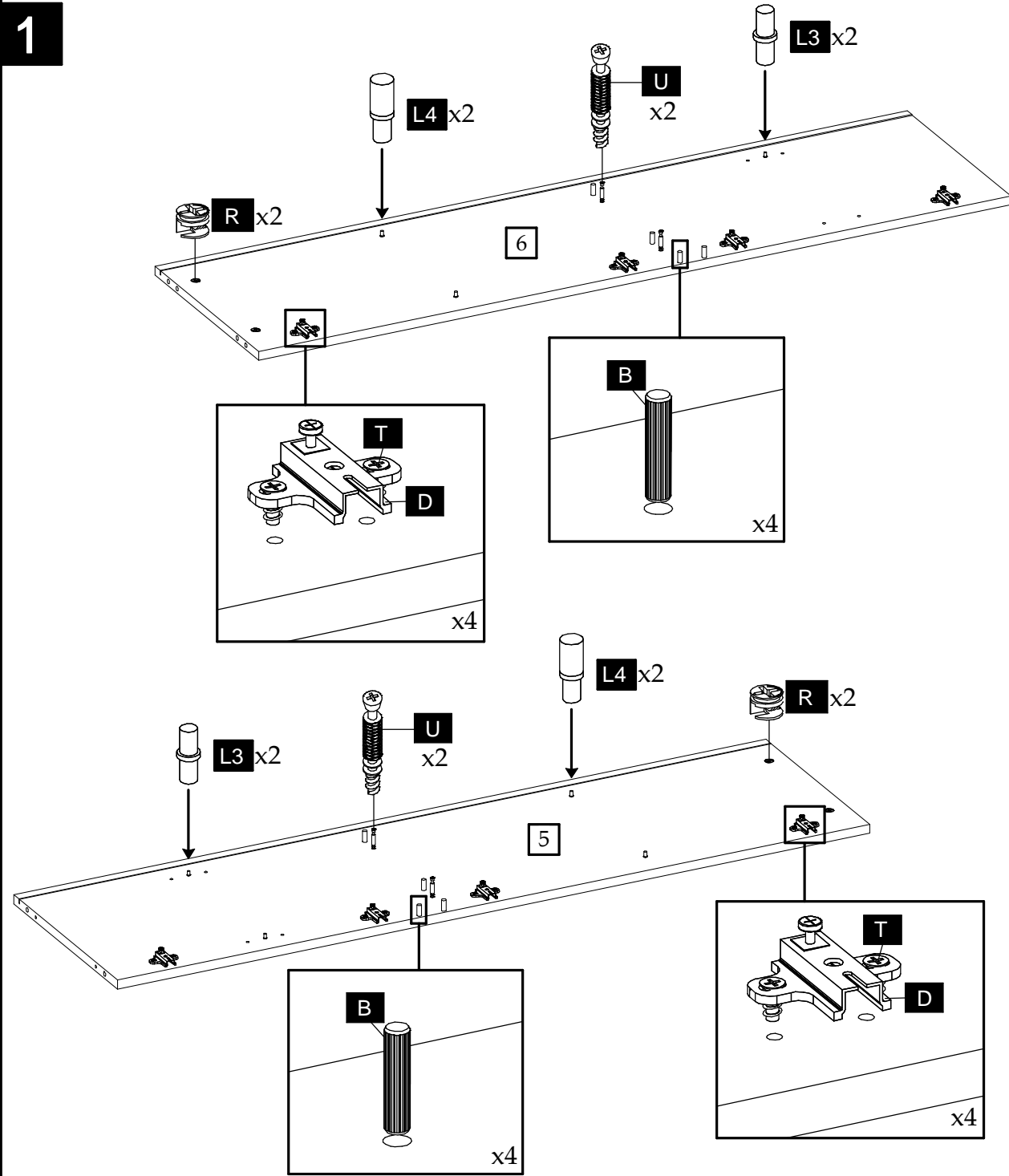

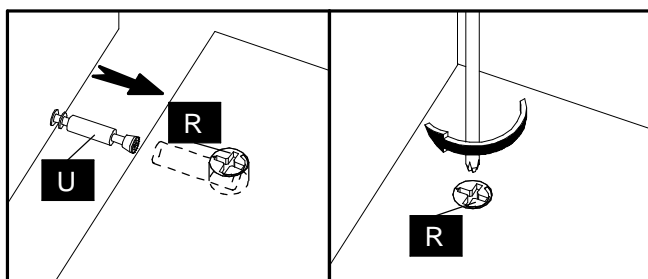
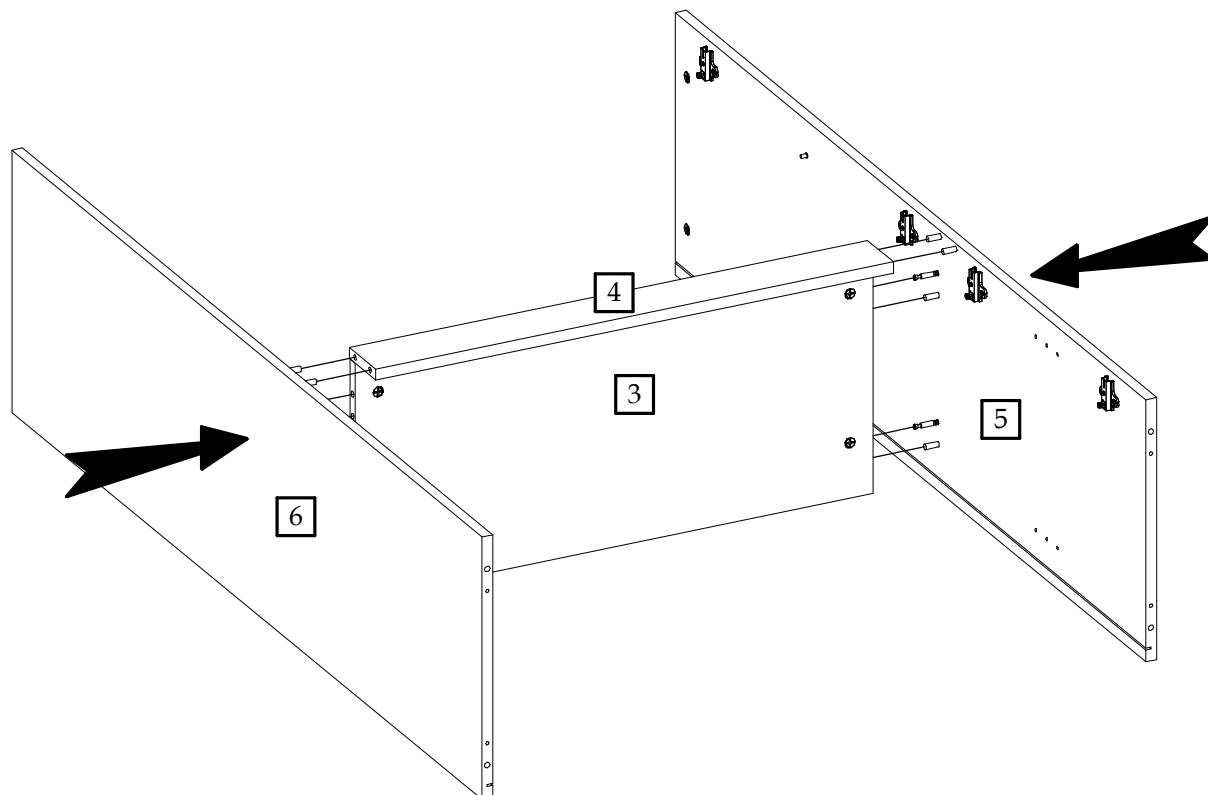
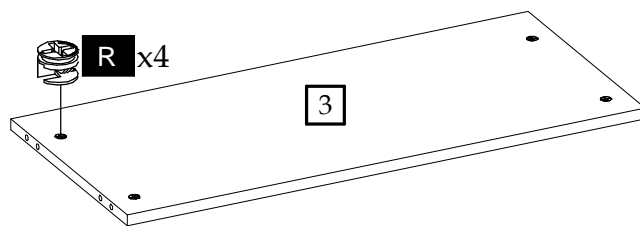

3

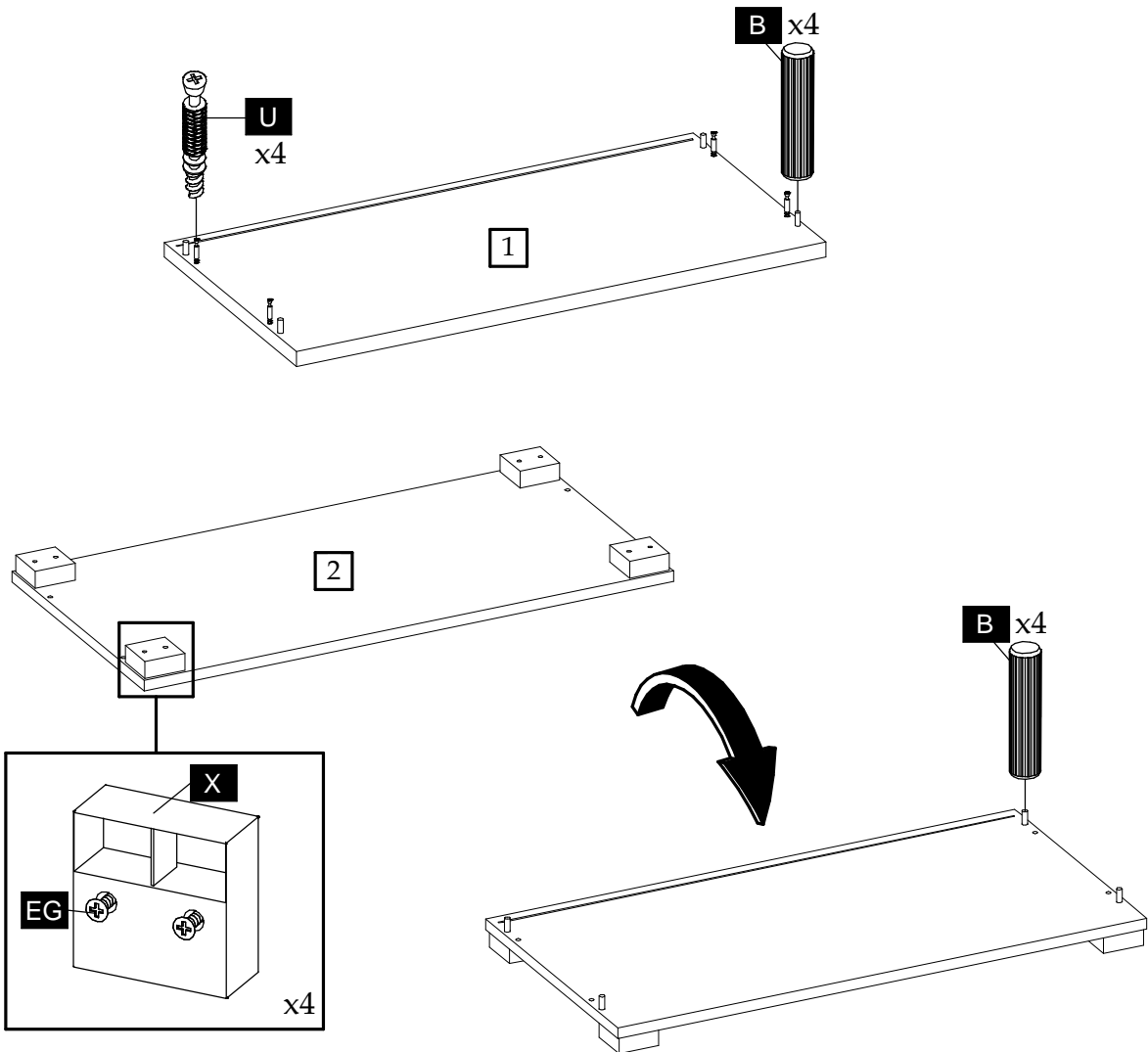

4

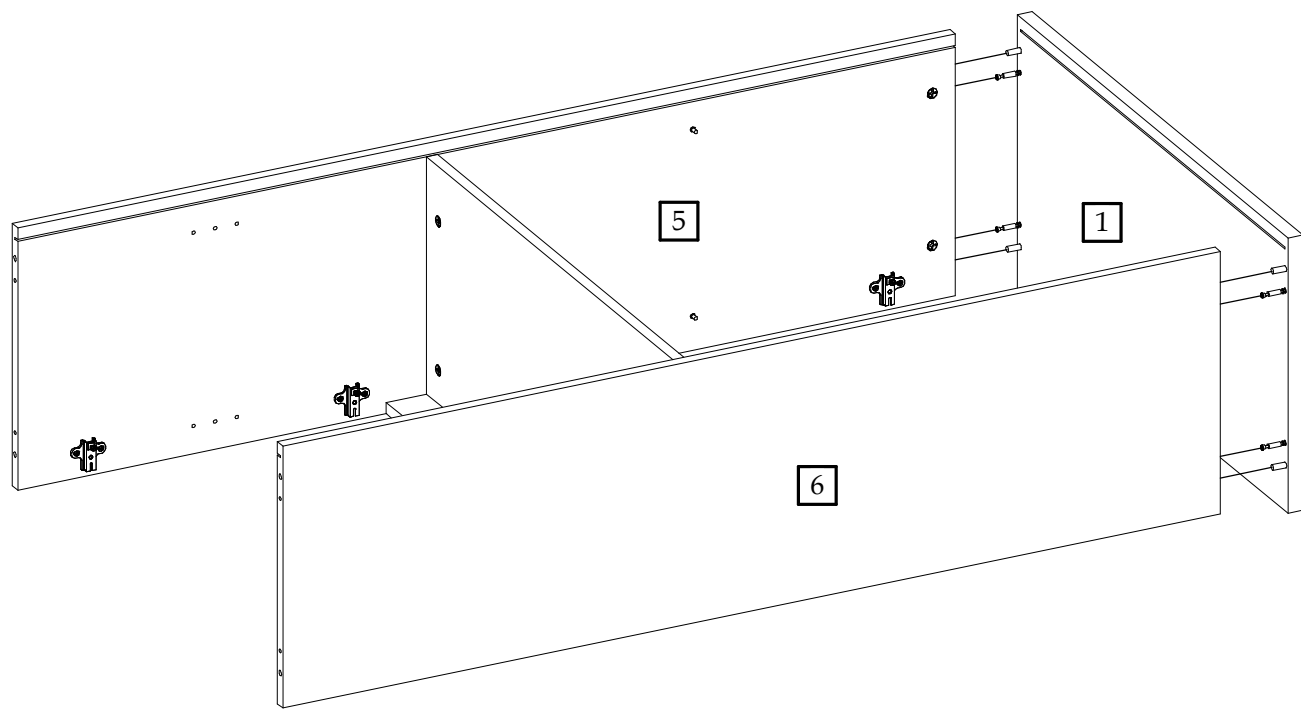

5

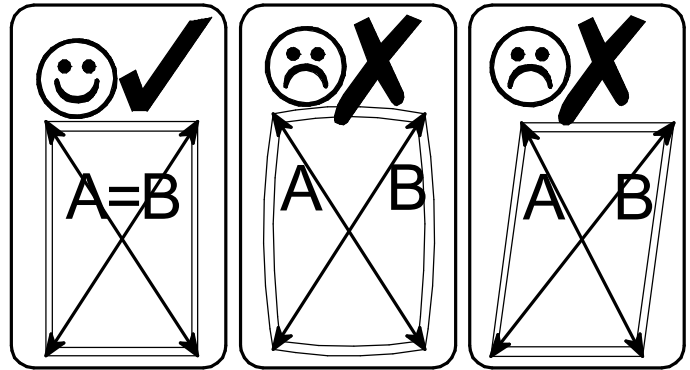
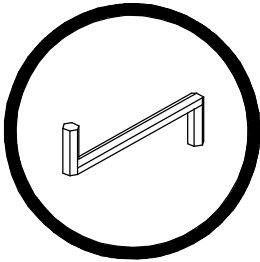
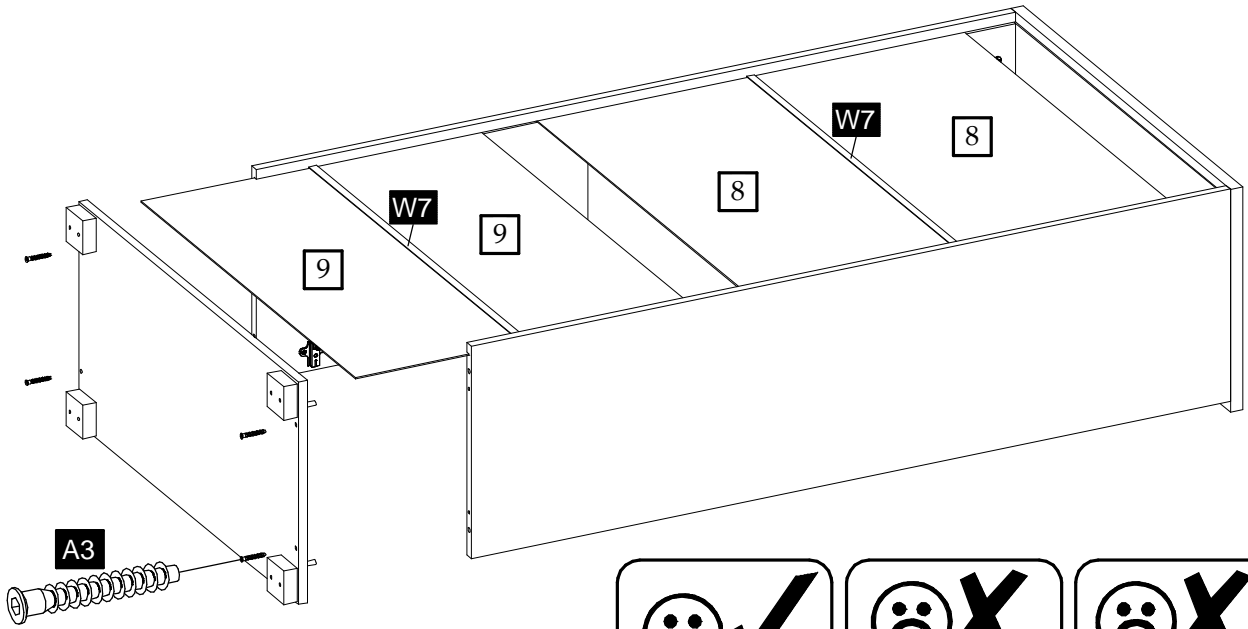

6

