

# VALLES

## Typ D

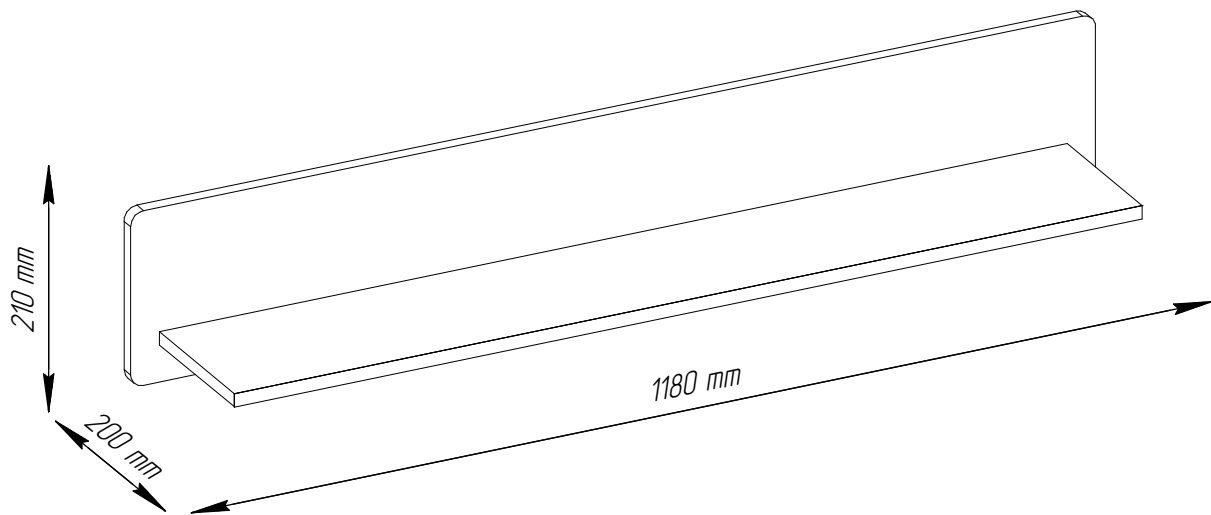

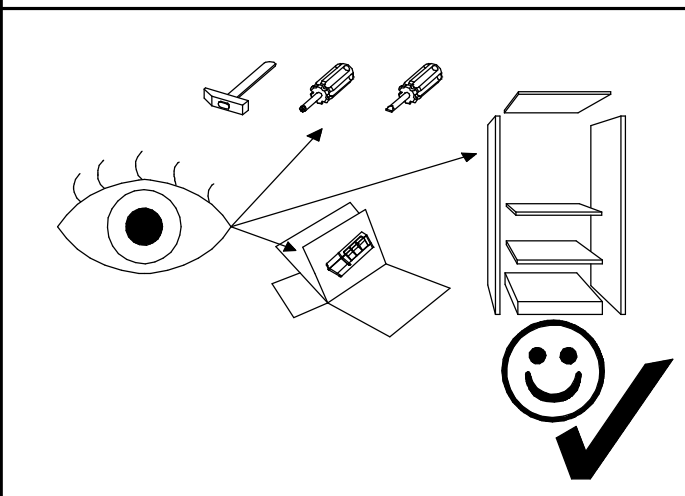

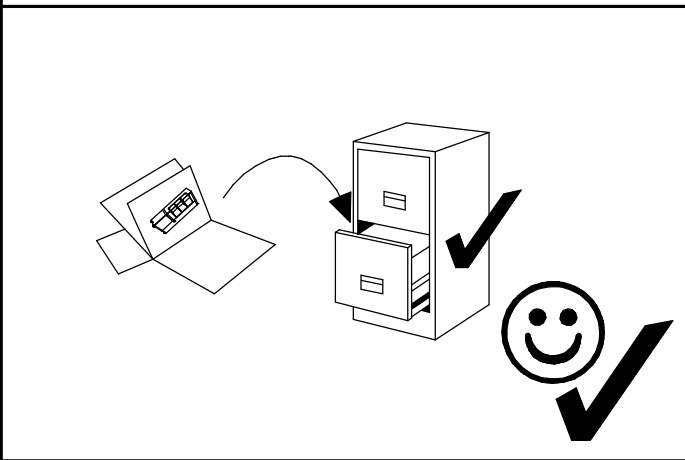
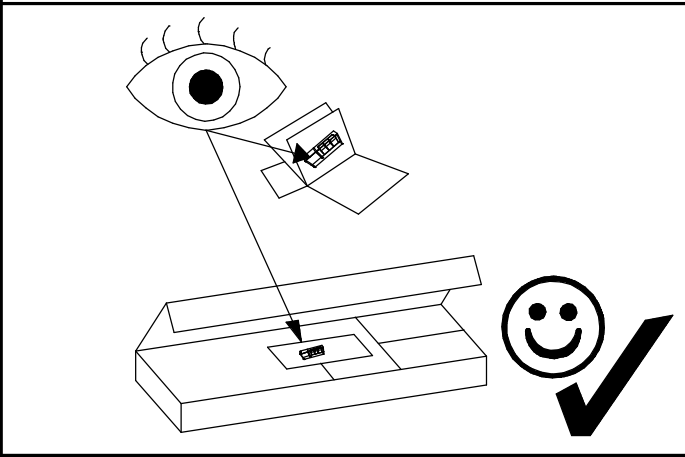
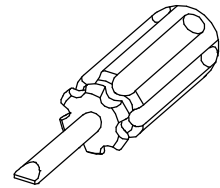
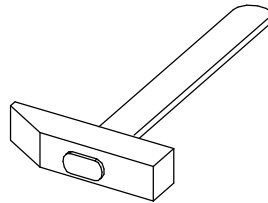
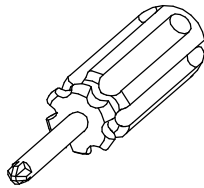
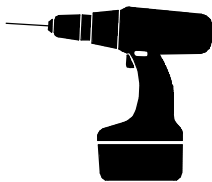
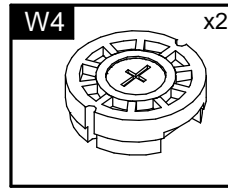
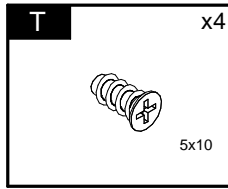
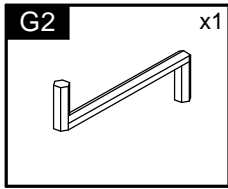
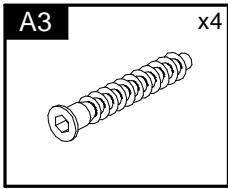

Element symbol	Measurements				Code	Paket
<b>1</b>	1180	210	16	1	3002	1/1
<b>2</b>	1110	184	16	1	1001	1/1

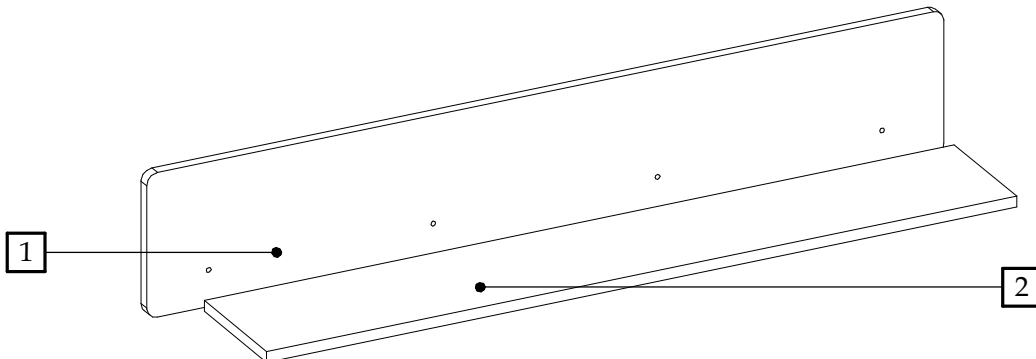

1

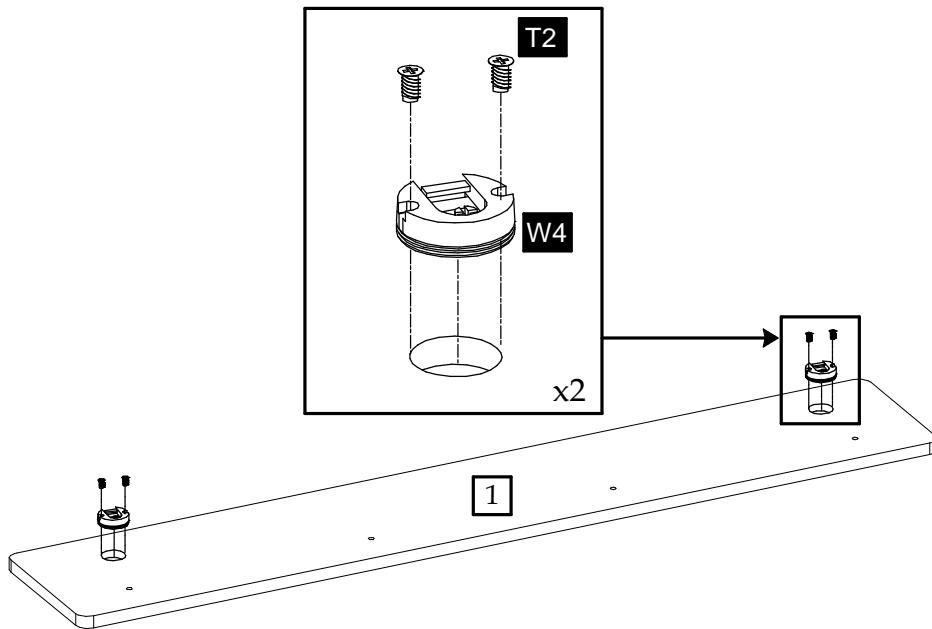

2

