

# VALLES

## Typ H

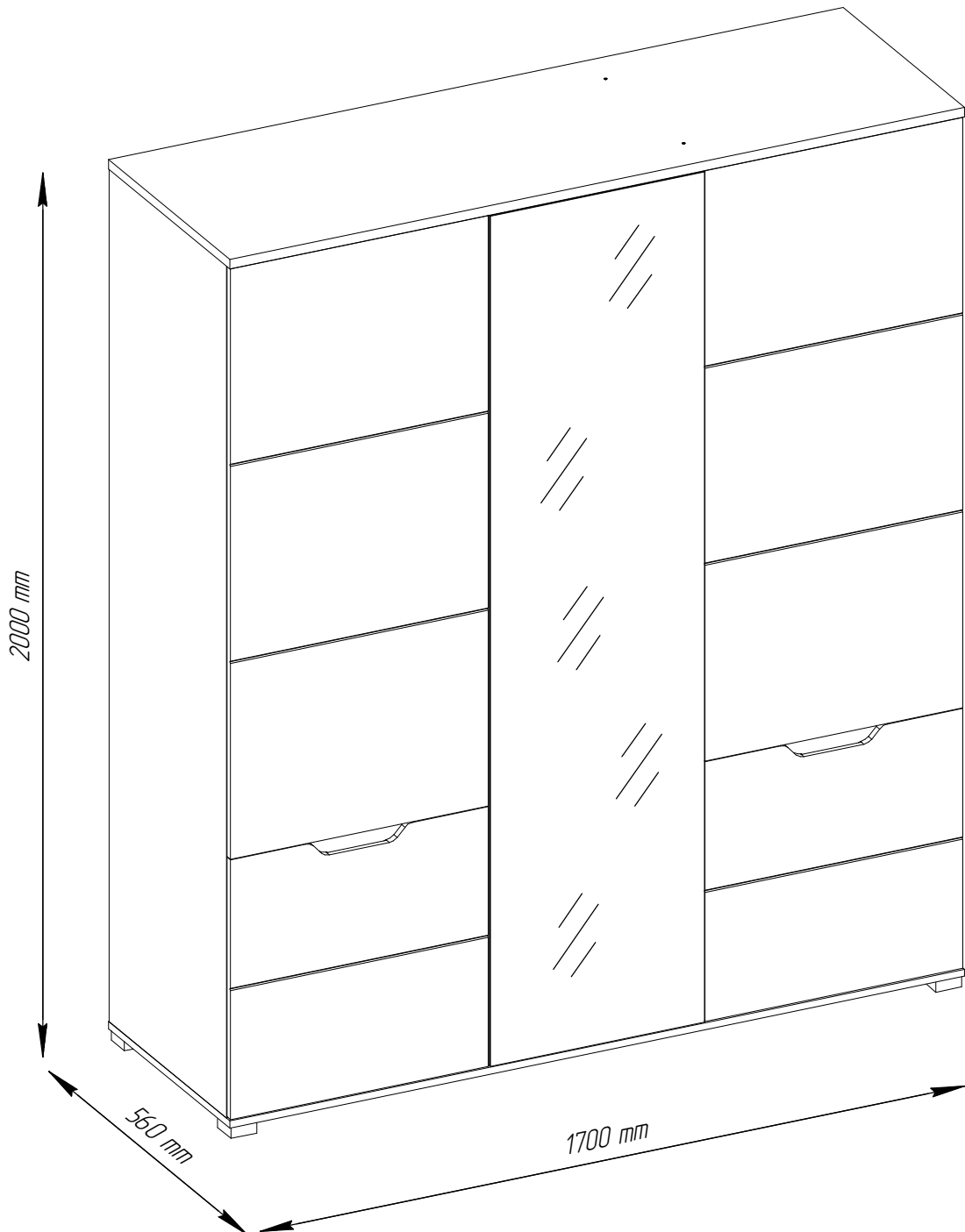

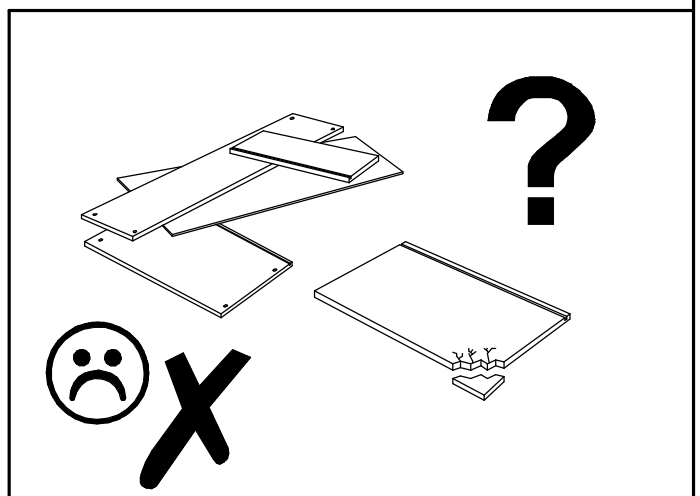

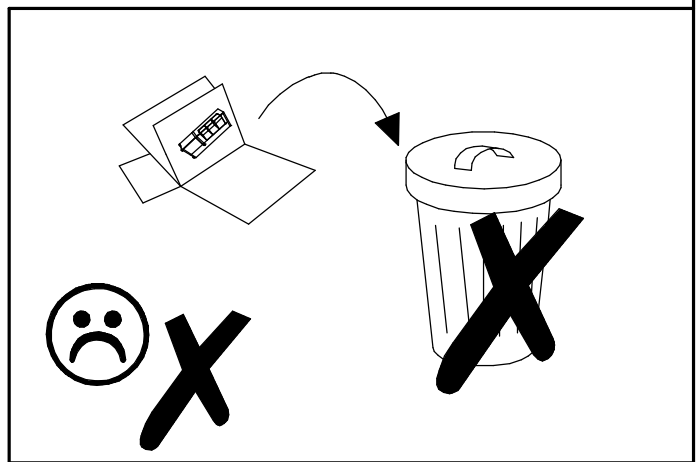
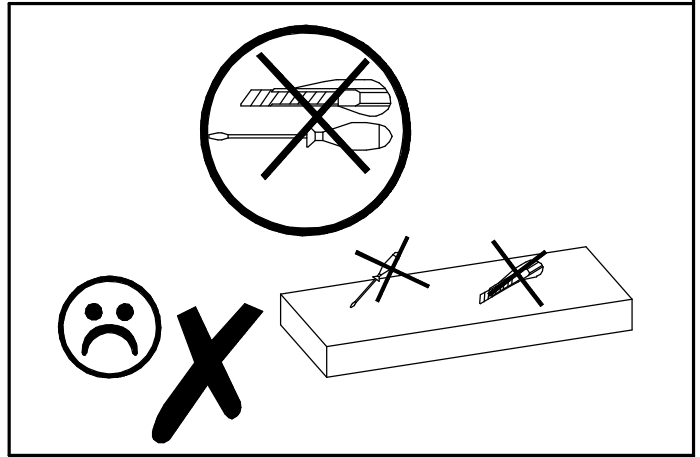
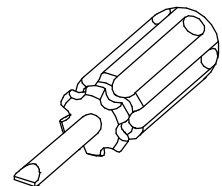
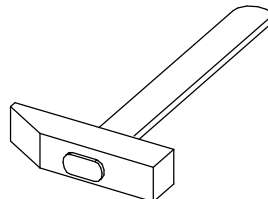
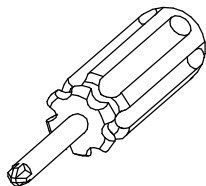
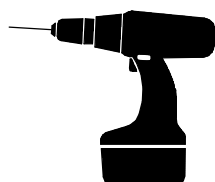
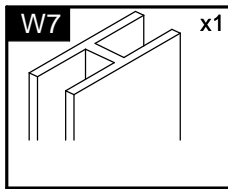
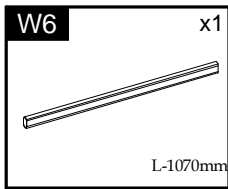
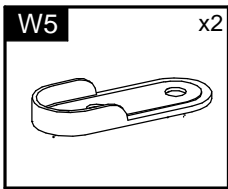
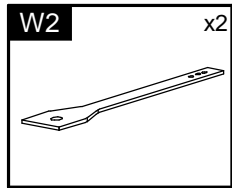
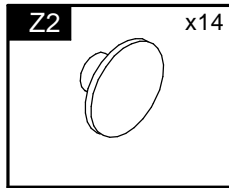
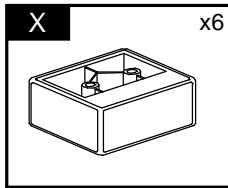
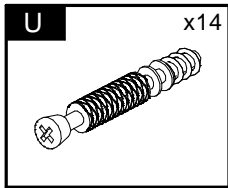
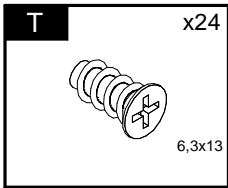
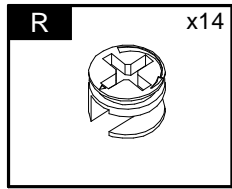
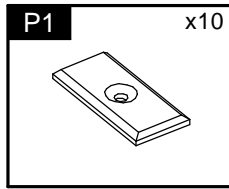
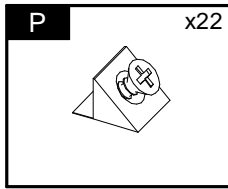
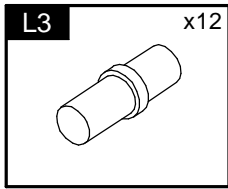
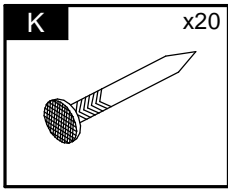
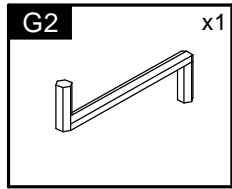
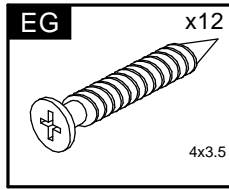
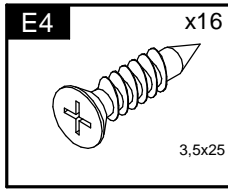
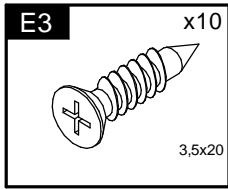
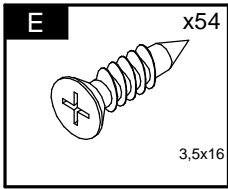
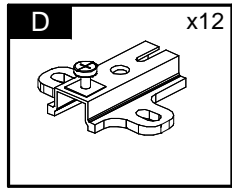
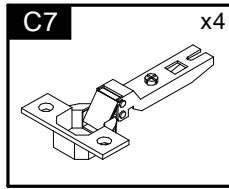
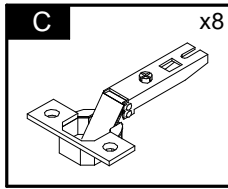
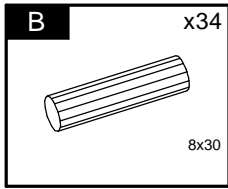
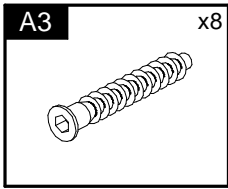

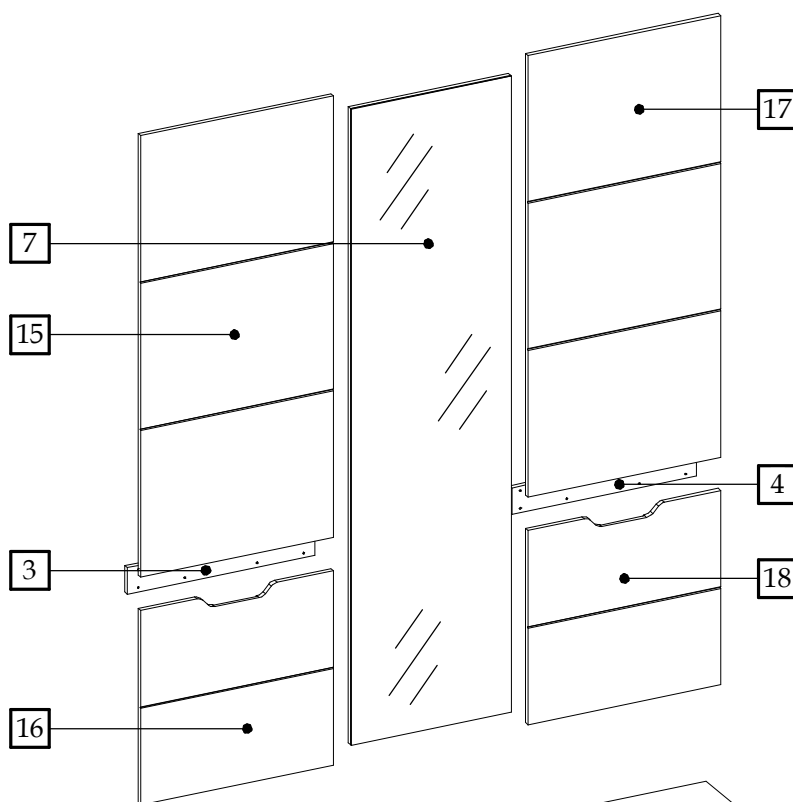

Element symbol	Measurements				Code	Paket
	W	H	T	Q		
1	1700	560	22	1	1004	3/4
2	1700	558.5	16	1	1001	3/4
3	580	80	16	1	1030	1/4
4	571	80	16	1	1031	1/4
5	1937	541	16	1	1002	2/4
6	1937	541	16	1	1003	2/4
7	1937	521	16	1	1025	1/4
8	1932	496	16	1	1027	2/4
9	1074.5	520.5	16	1	1028	1/4
10	1074.5	100	16	1	1029	1/4
11	575.5	520.5	16	1	1019	1/4
12	575.5	511	16	3	N/A	1/4
13	1950	589	2.5	1	N/A	2/4
14	1950	544	2.5	2	N/A	1/4
15	1341	596	16	1	3024	4/4
16	590	596	16	1	3025	4/4
17	1341	596	16	1	3026	4/4
18	590	596	16	1	3027	4/4

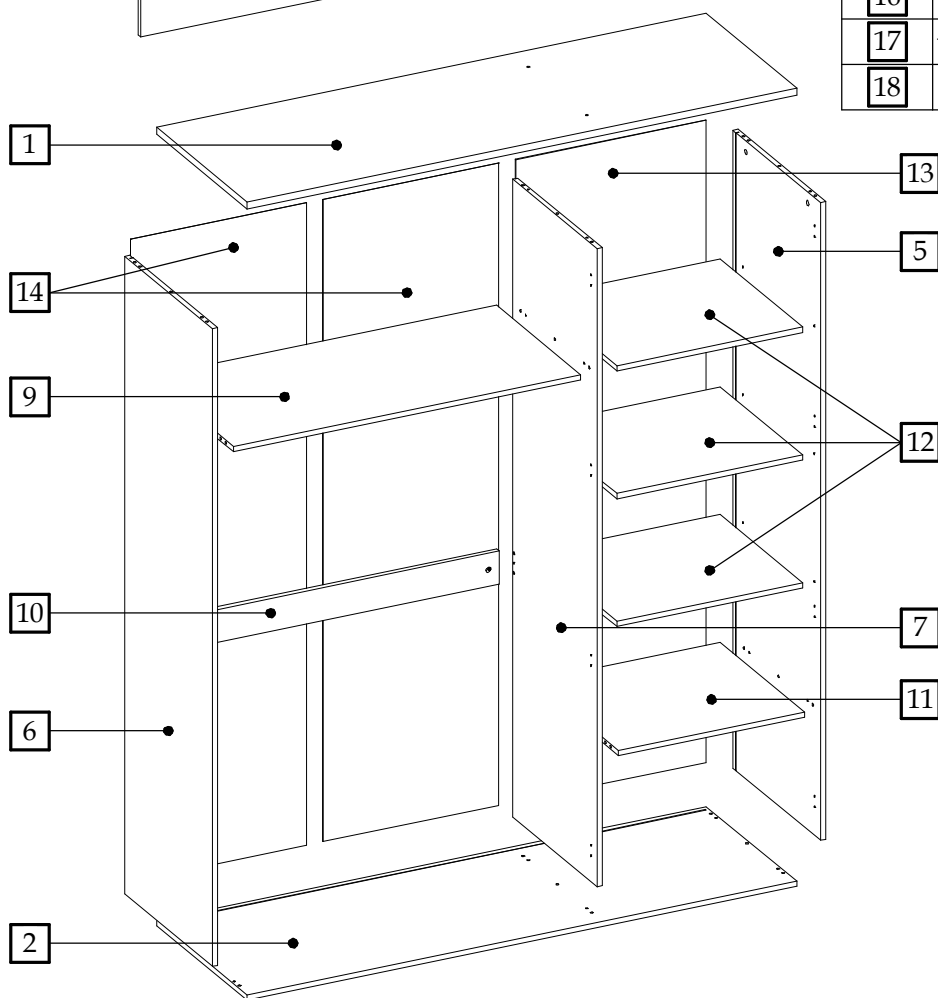



1

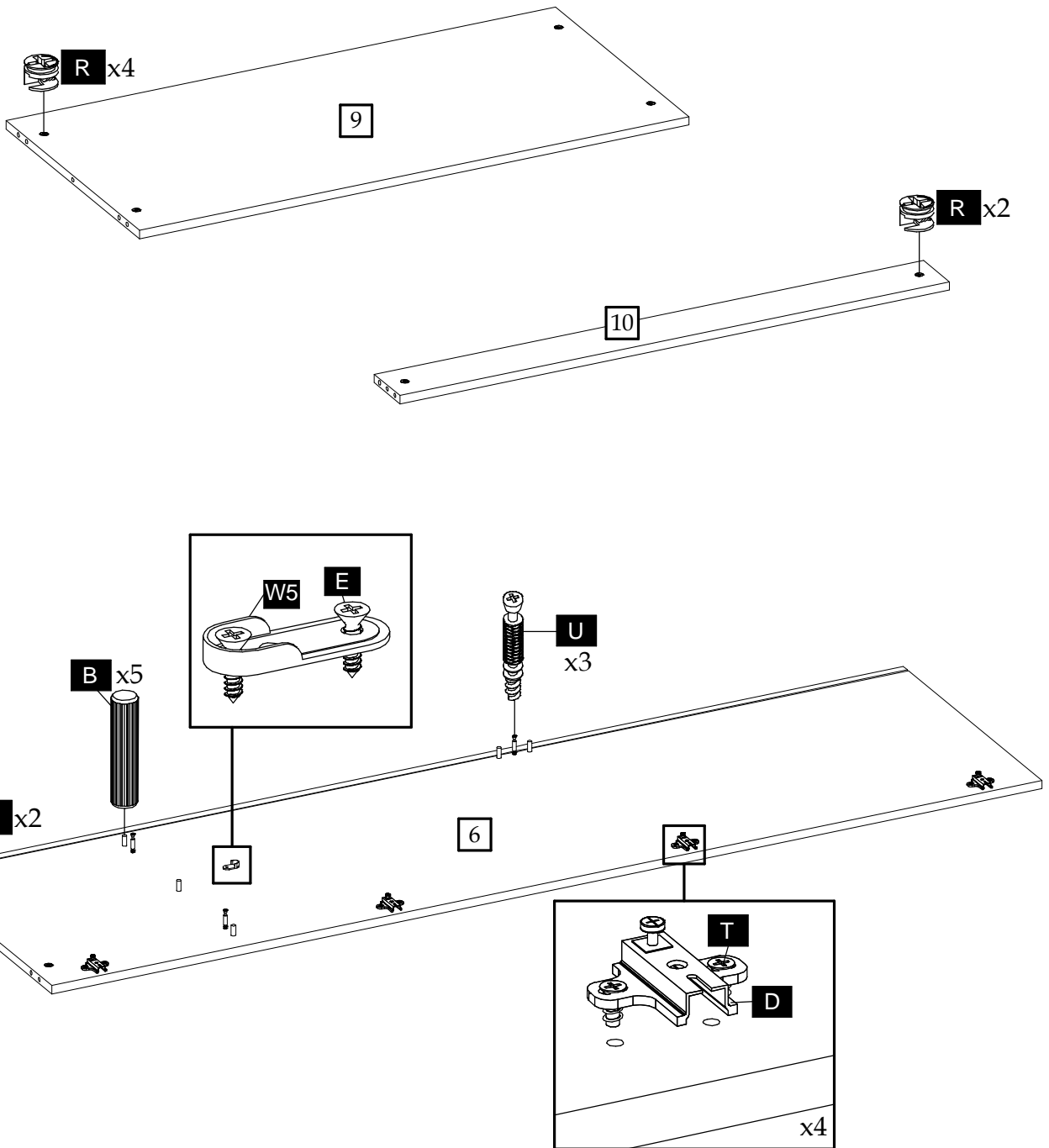

2

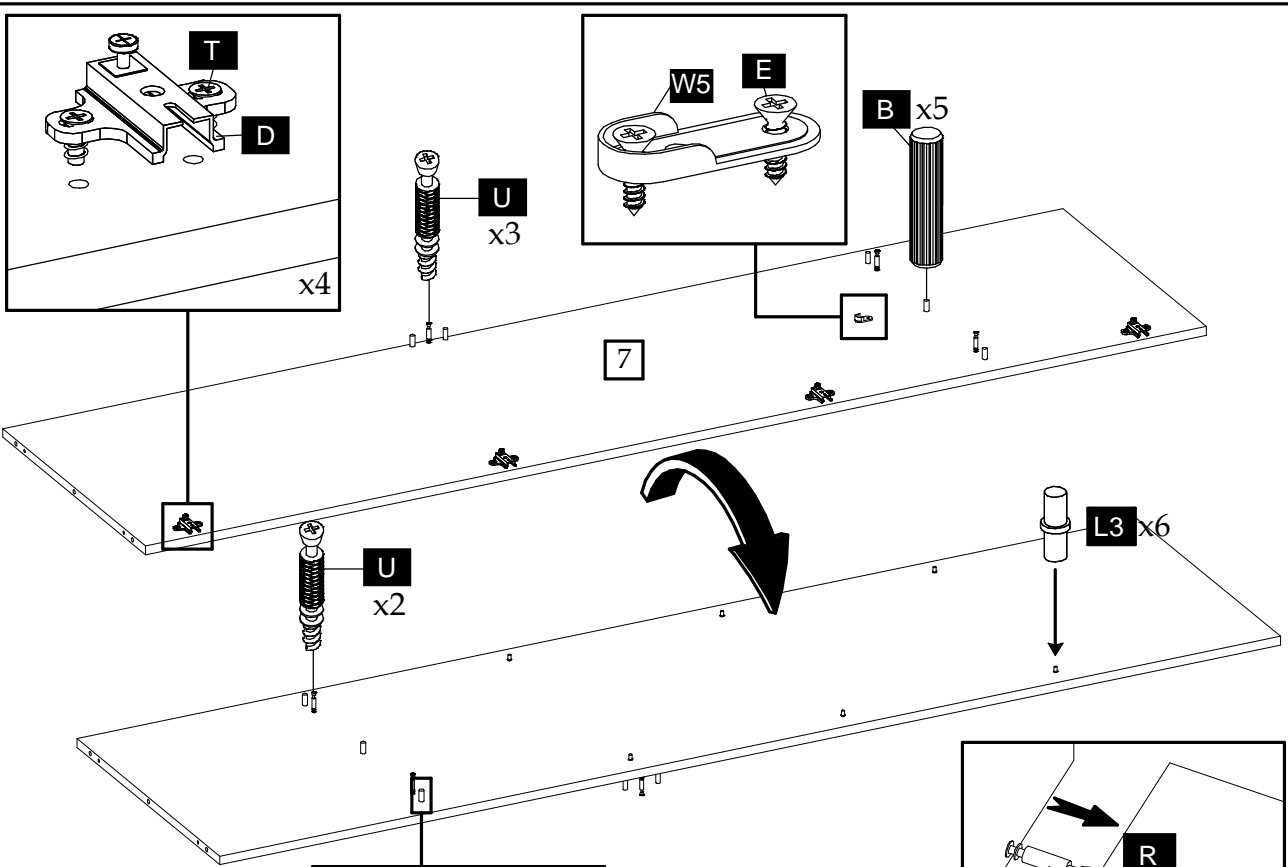

3

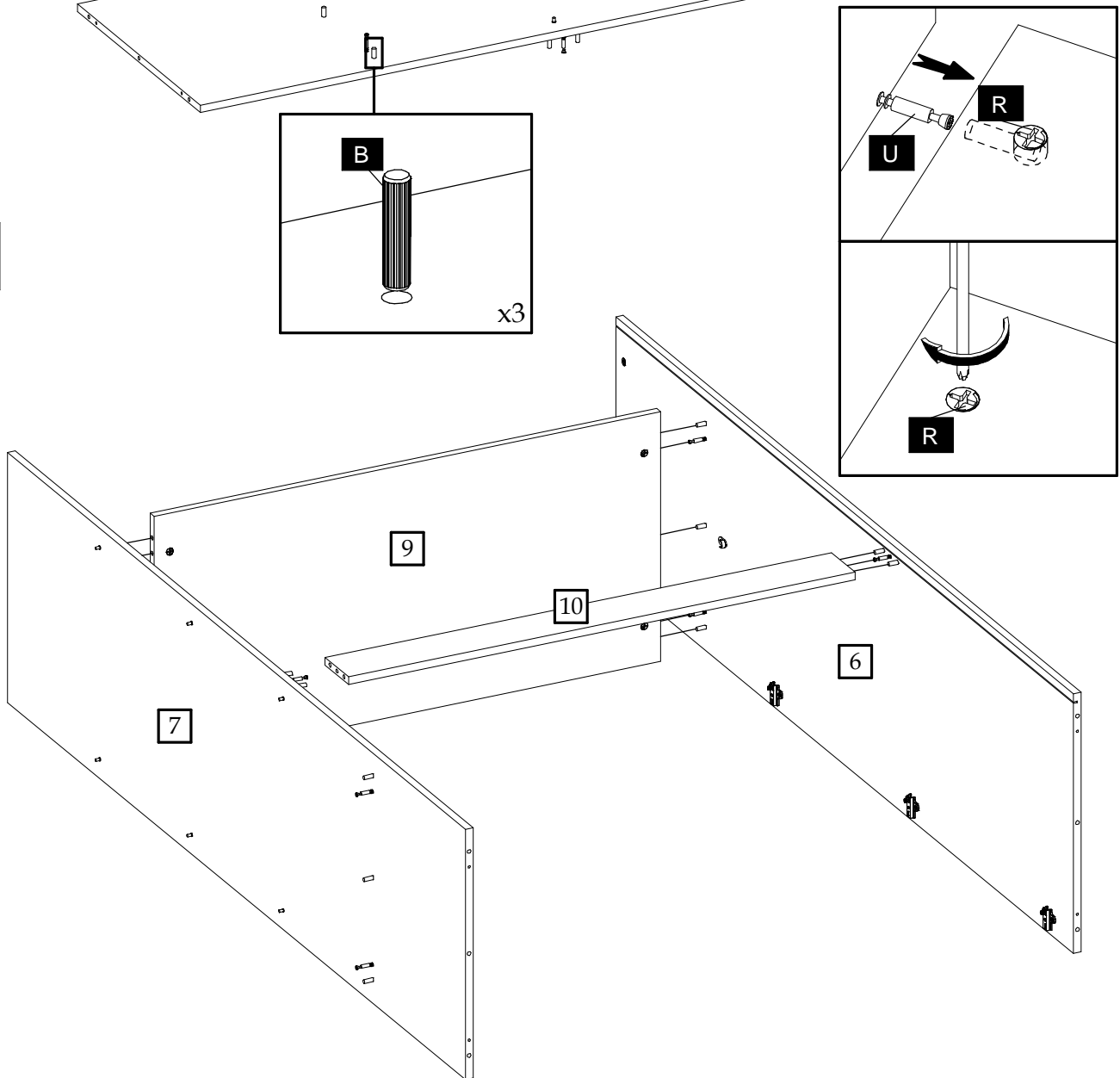

4

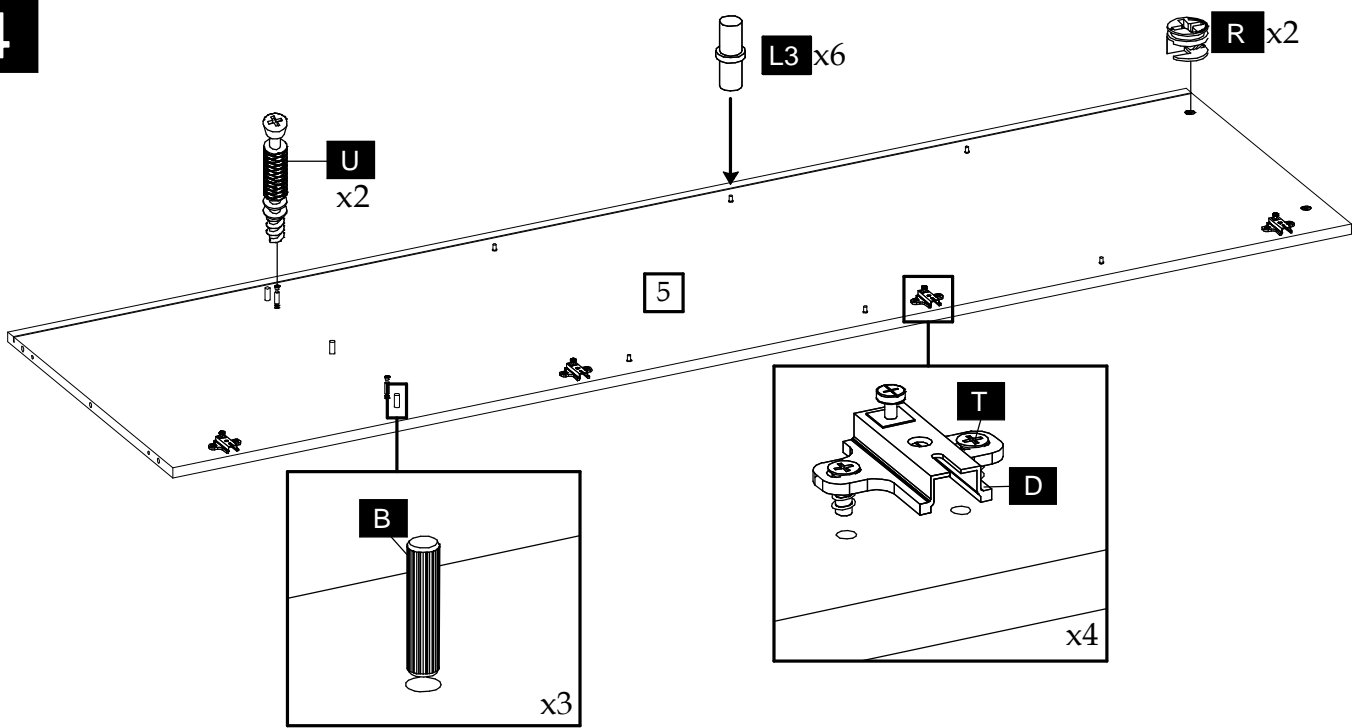

5

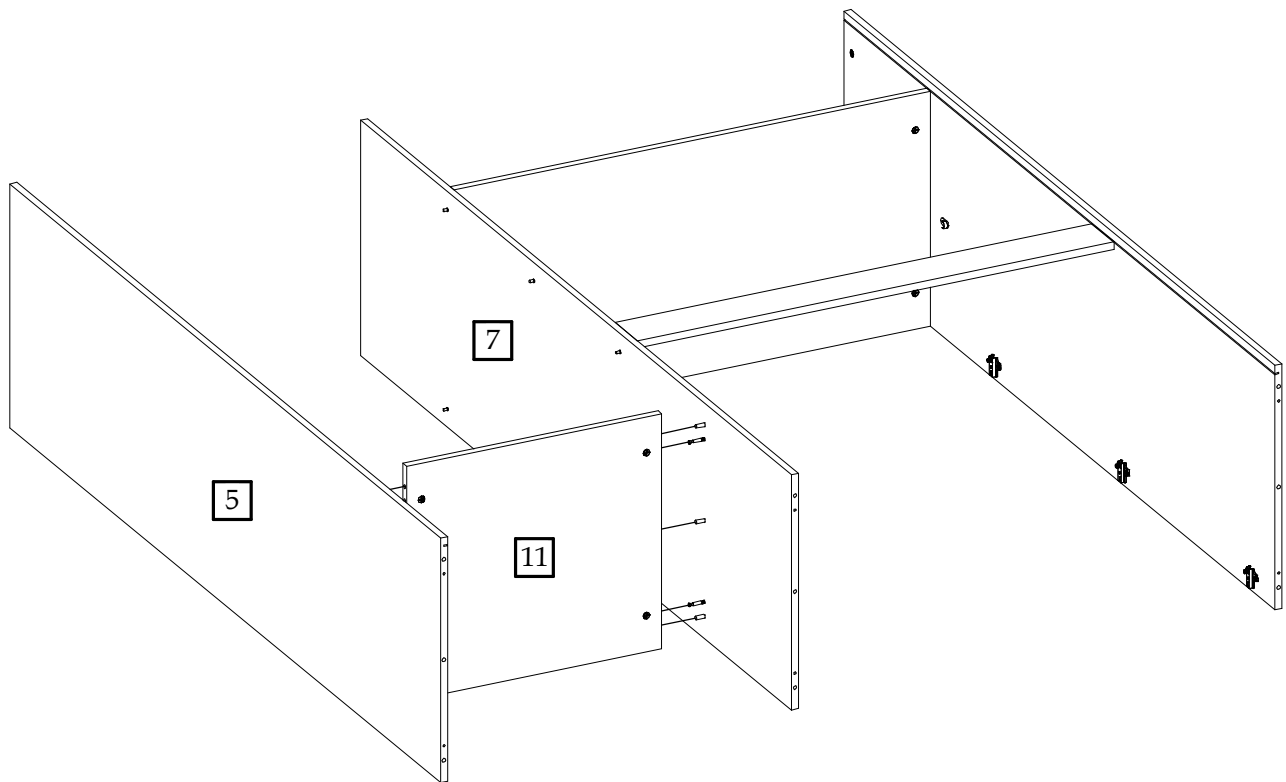
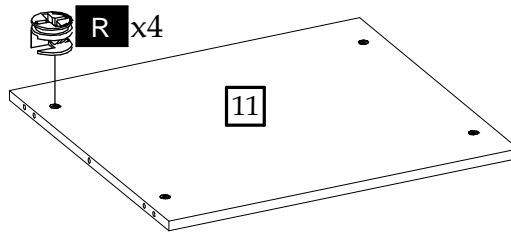

6

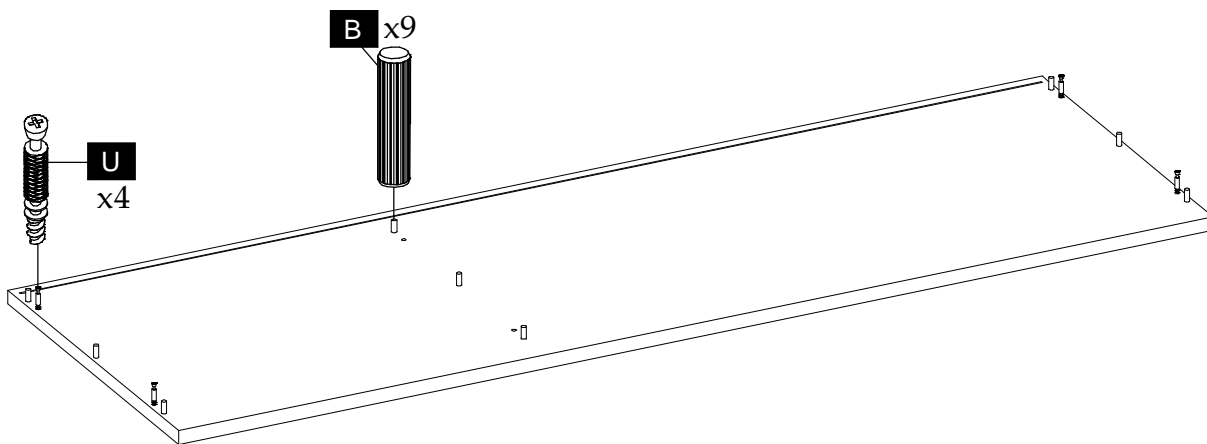

7

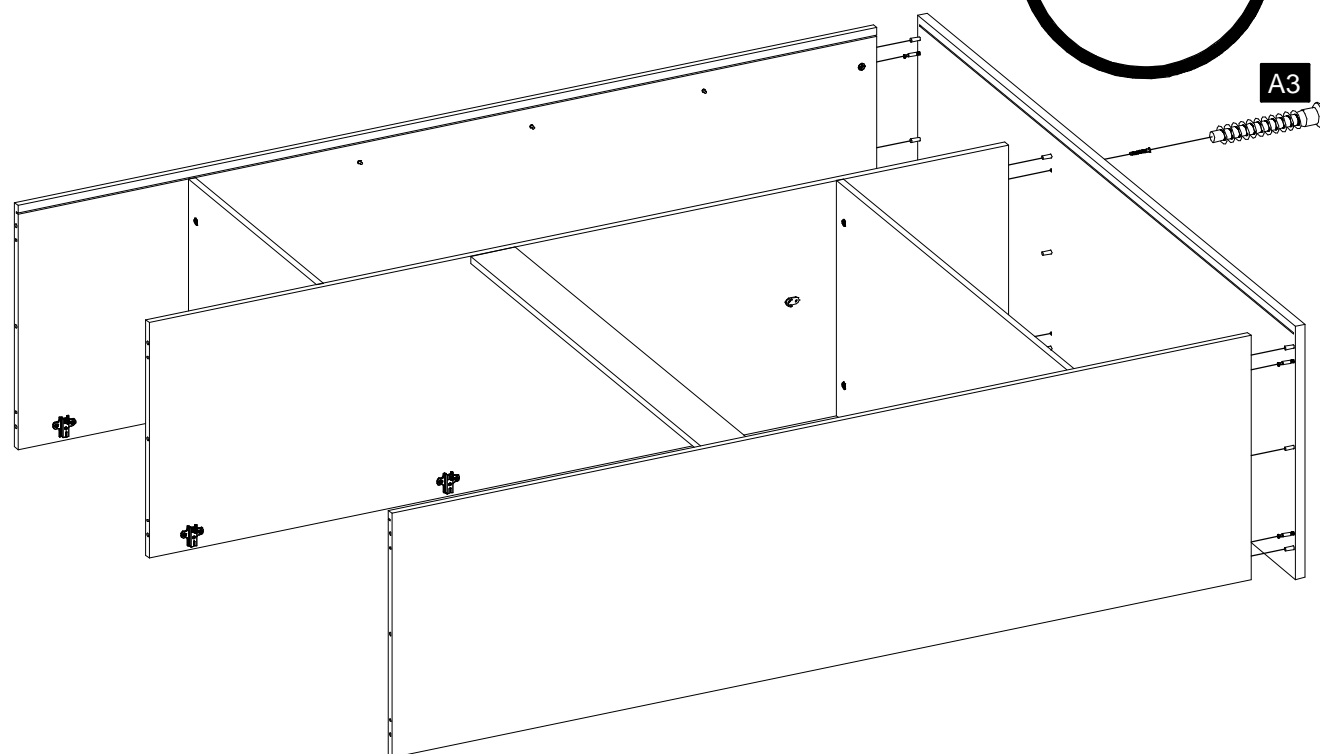
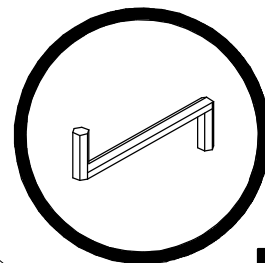
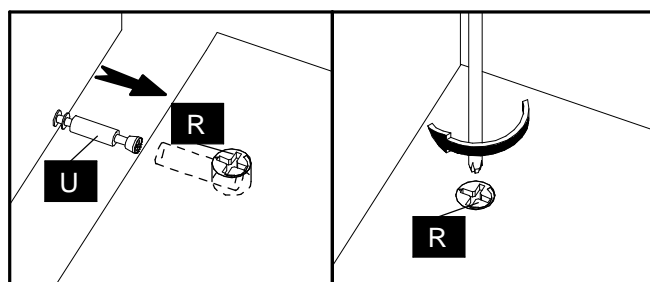



8

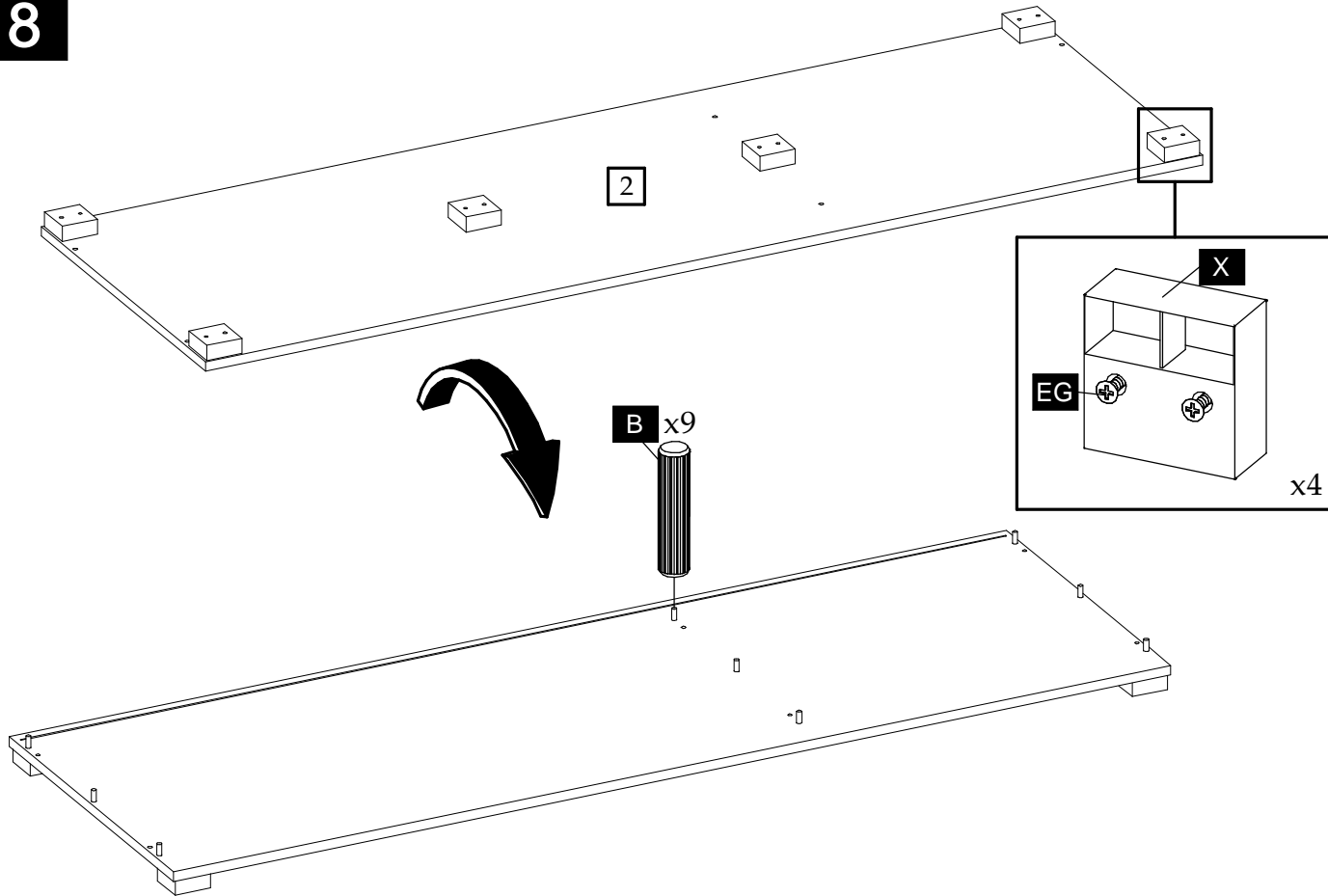

9

