

# VALLES

## Typ Q

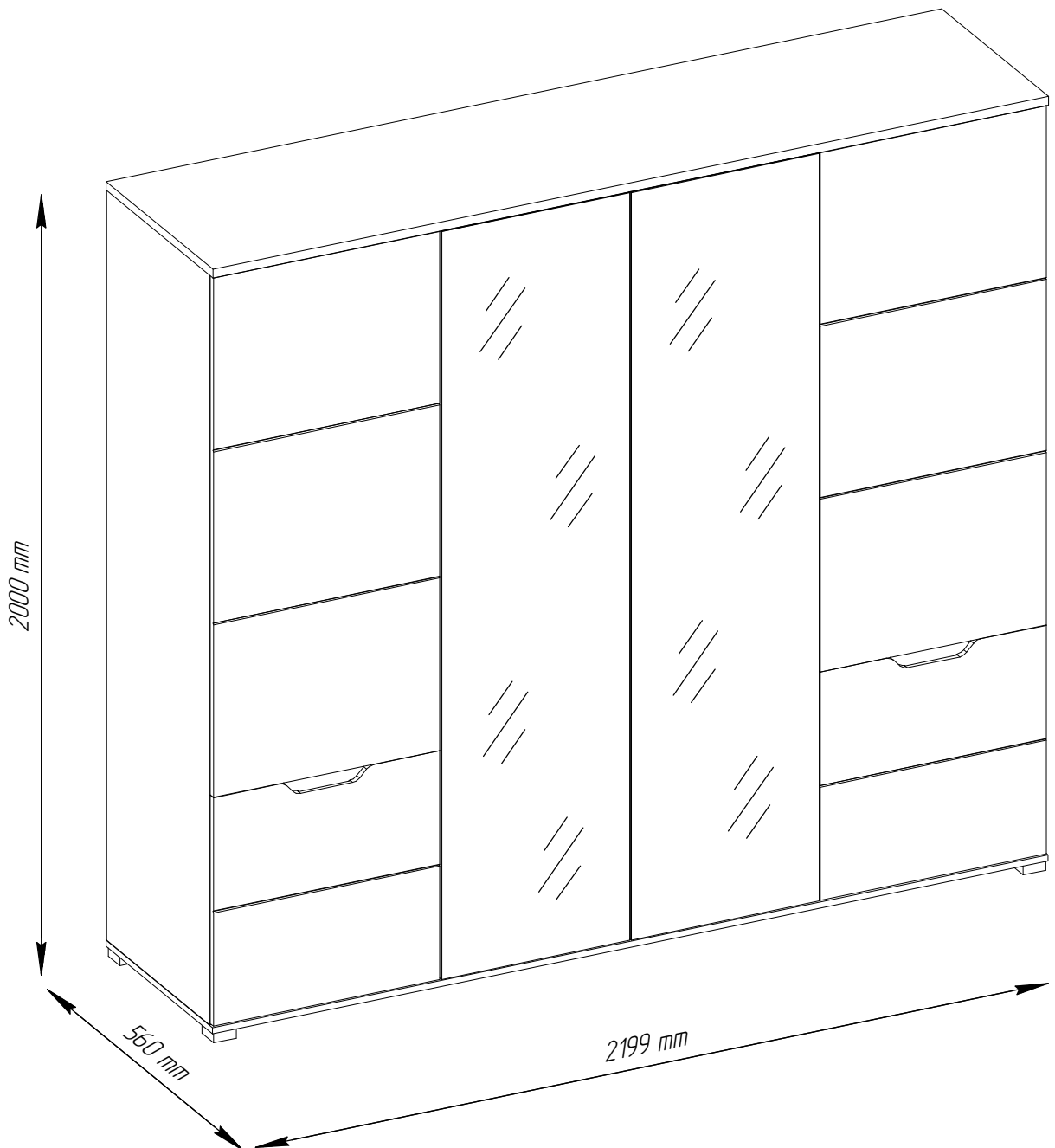

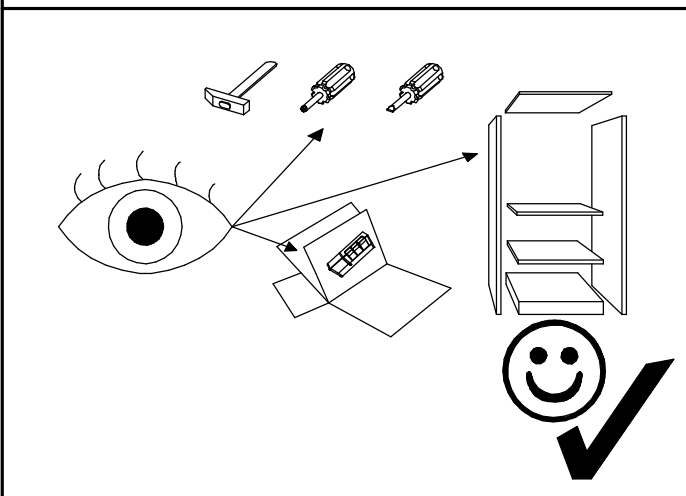

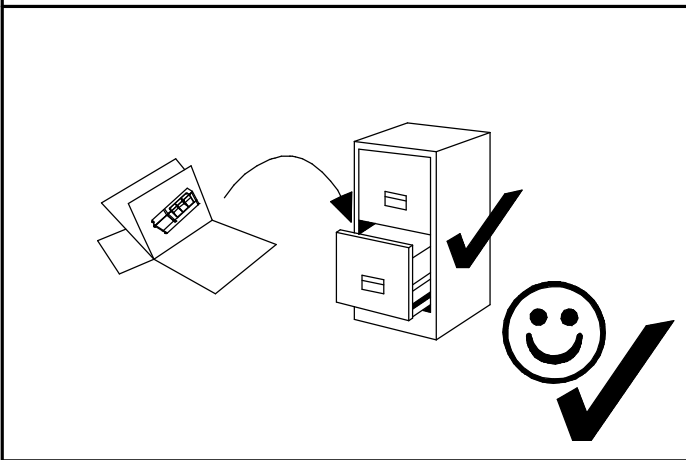
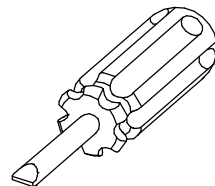
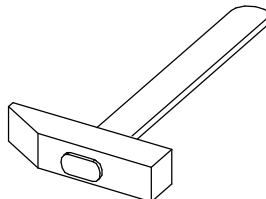
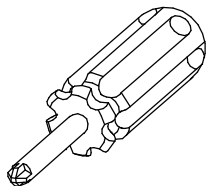
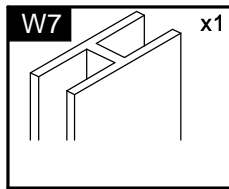
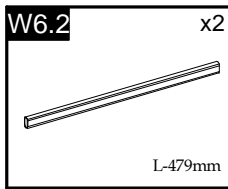
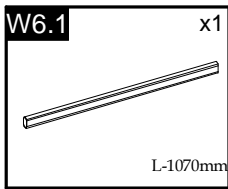
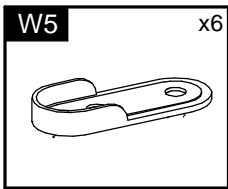
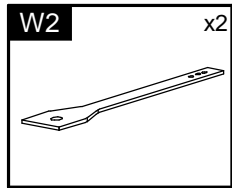
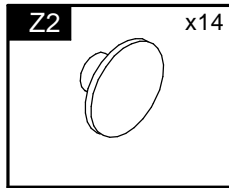
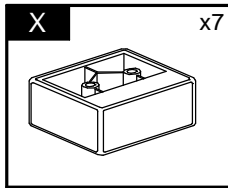
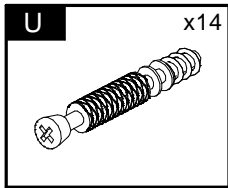
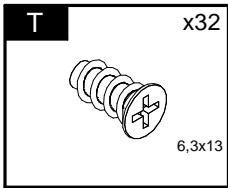
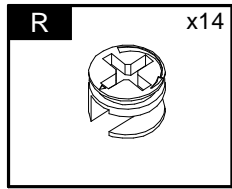
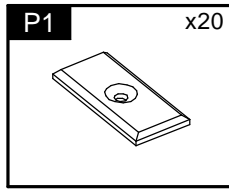
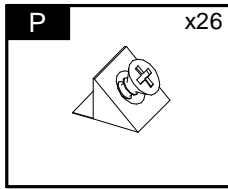
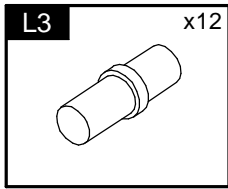
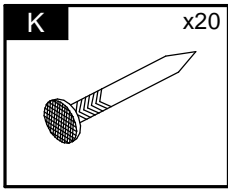
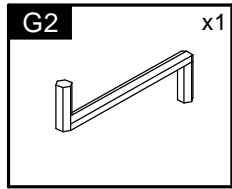
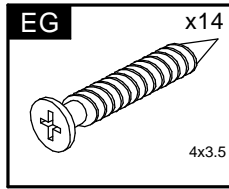
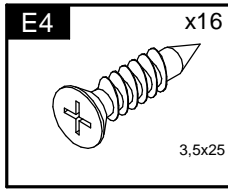
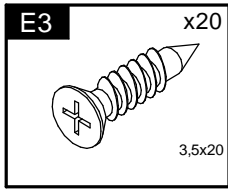
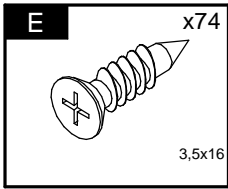
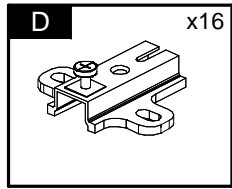
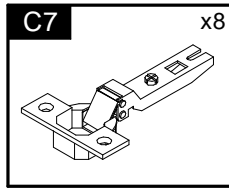
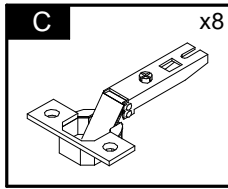
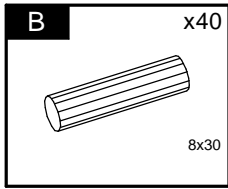
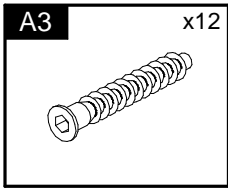

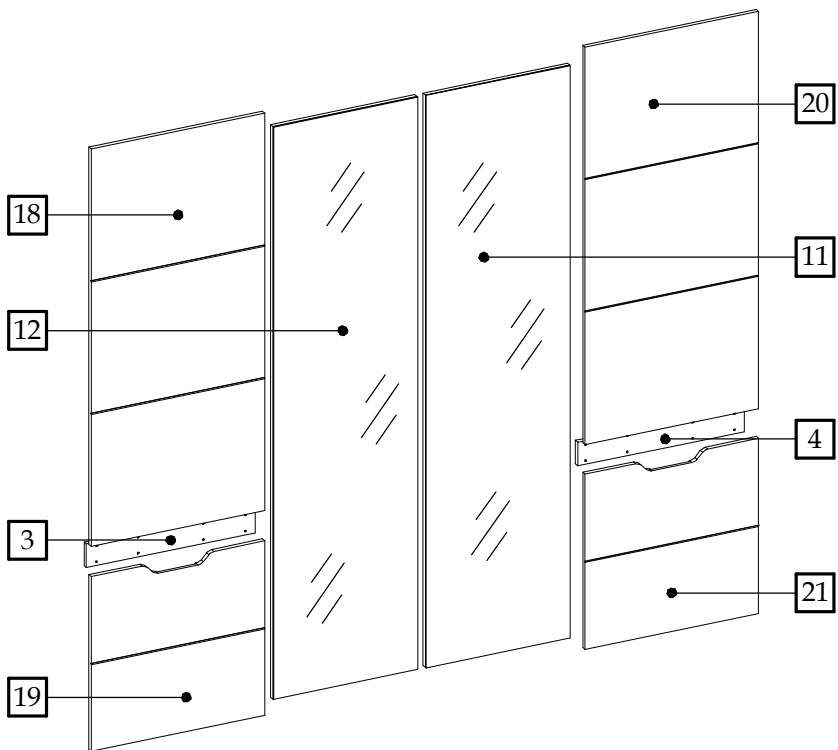

Element symbol	Measurements				Code	Paket
	W	H	T	Q		
1	2199	560	22	1	1004	3/4
2	2199	558.5	16	1	1001	3/4
3	580	80	16	1	1032	4/4
4	571	80	16	1	1031	4/4
5	1937	541	16	1	1002	1/4
6	1937	541	16	1	1003	1/4
7	1937	521	16	1	1024	2/4
8	1937	521	16	1	1014	2/4
9	1074.5	520.5	16	1	1027	1/4
10	1074.5	100	16	1	1028	1/4
11	1932	496	16	1	1026	2/4
12	1932	496	16	1	1029	2/4
13	575.5	520.5	16	1	1030	1/4
14	575.5	511	16	3	N/A	1/4
15	1950	589	2.5	1	N/A	3/4
16	1950	498	2.5	1	N/A	3/4
17	1950	544	2.5	2	N/A	3/4
18	1341	596	16	1	3024	4/4
19	590	596	16	1	3025	4/4
20	1341	596	16	1	3026	4/4
21	590	596	16	1	3027	4/4

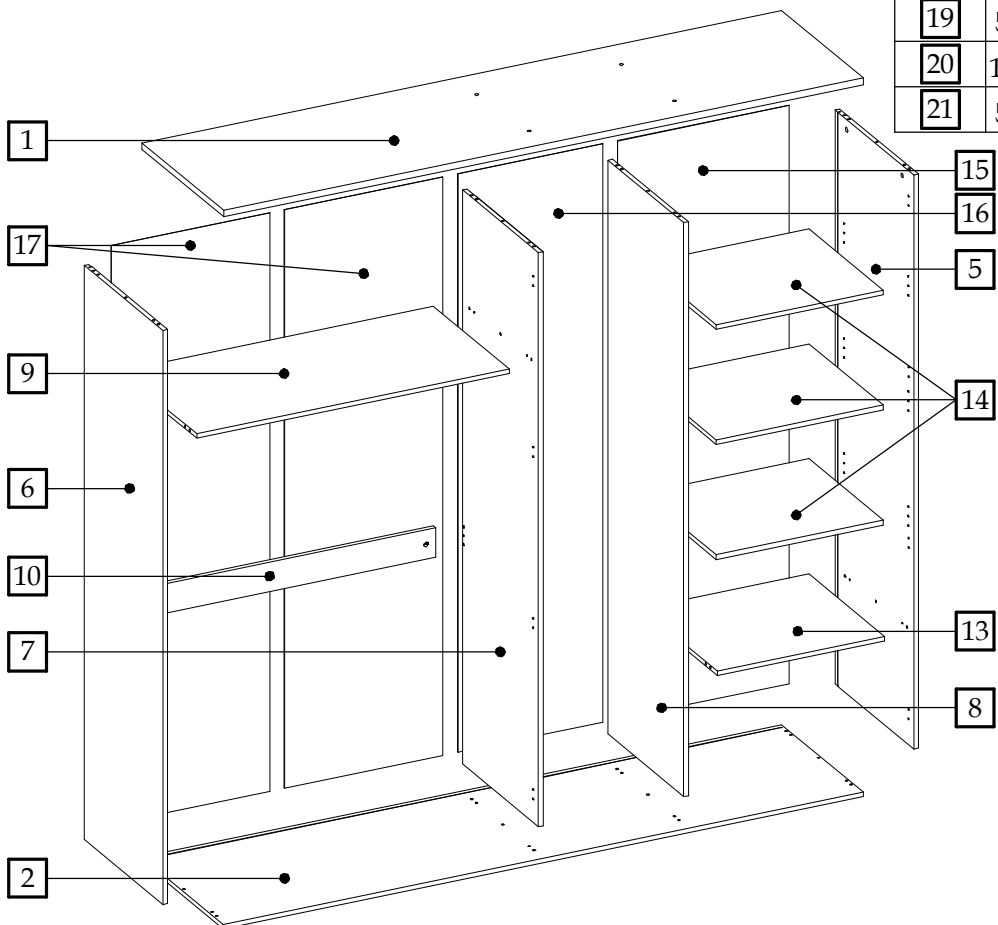



1

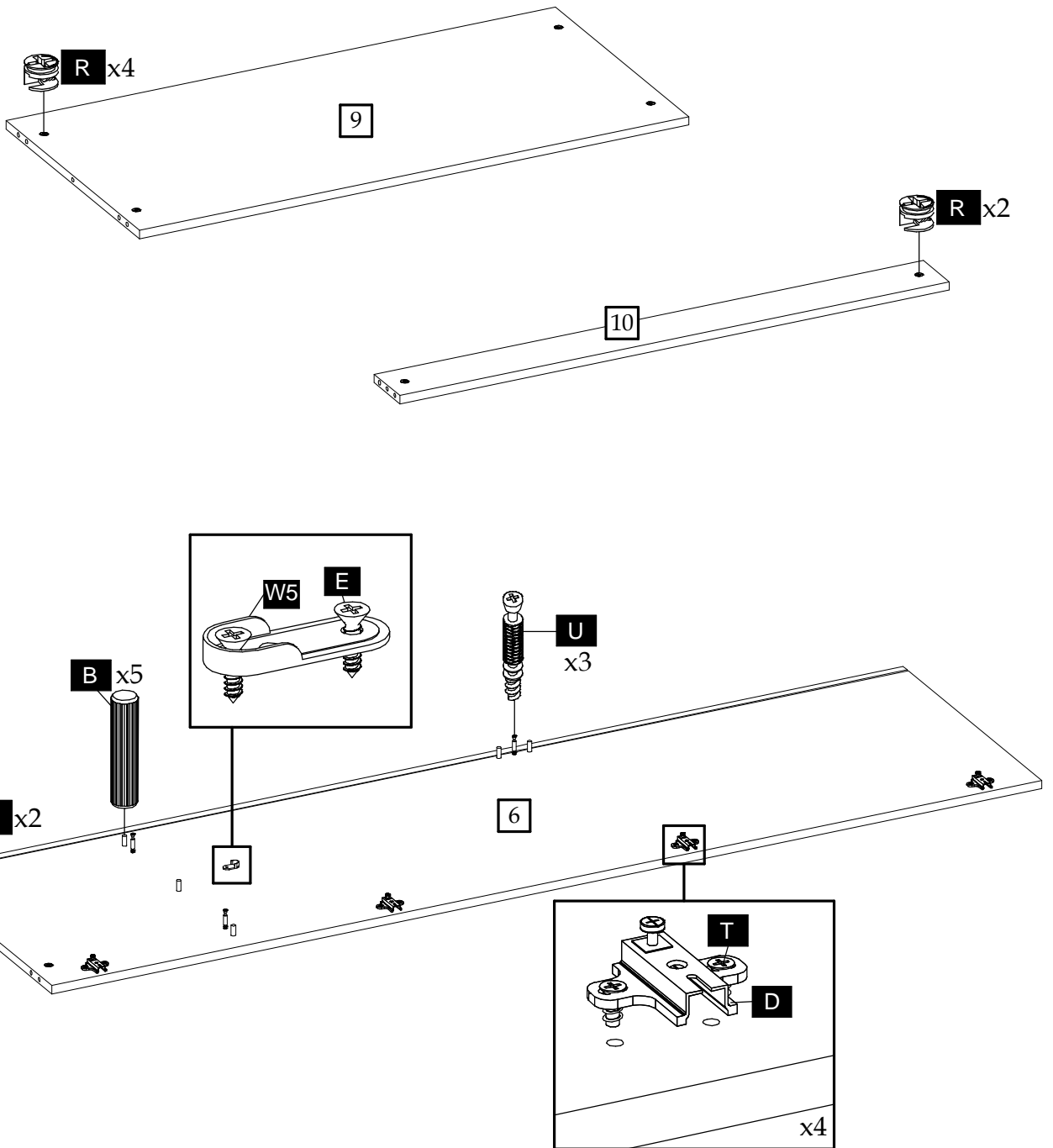

2

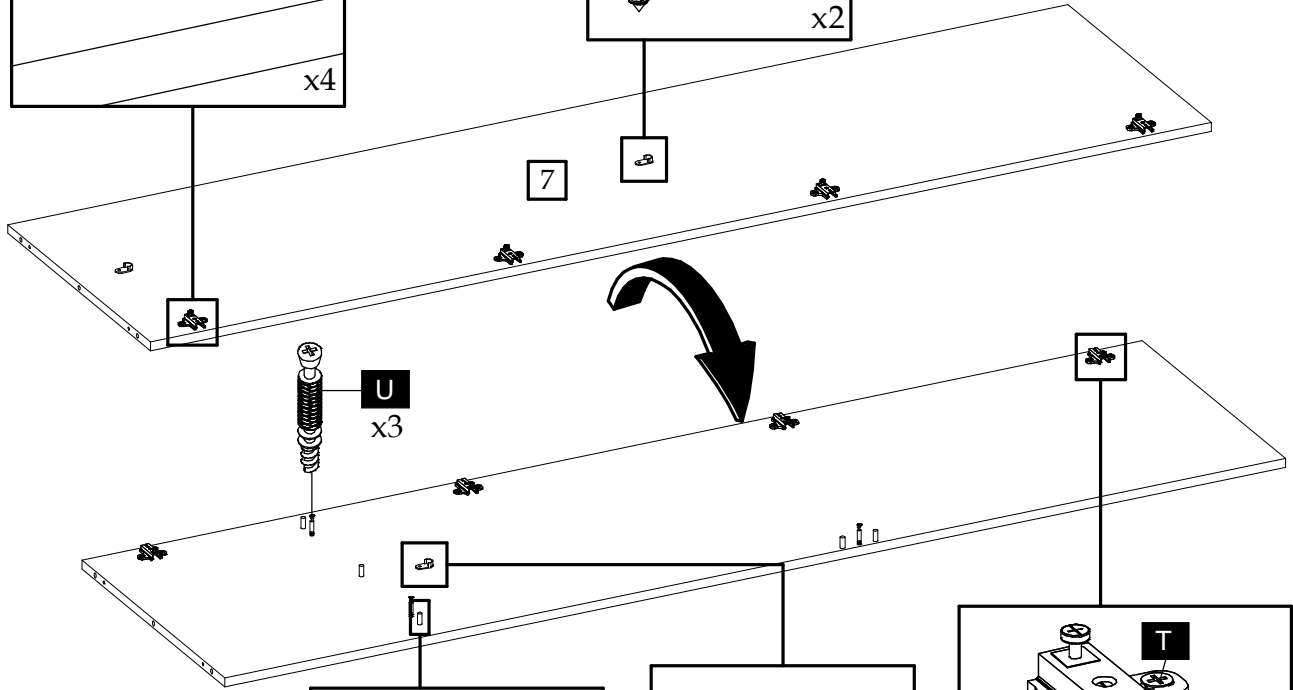
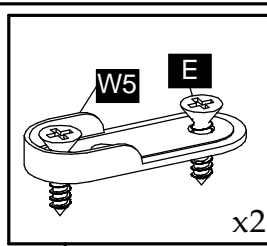
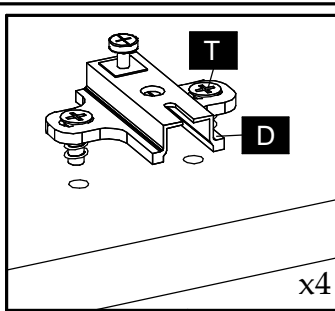

3

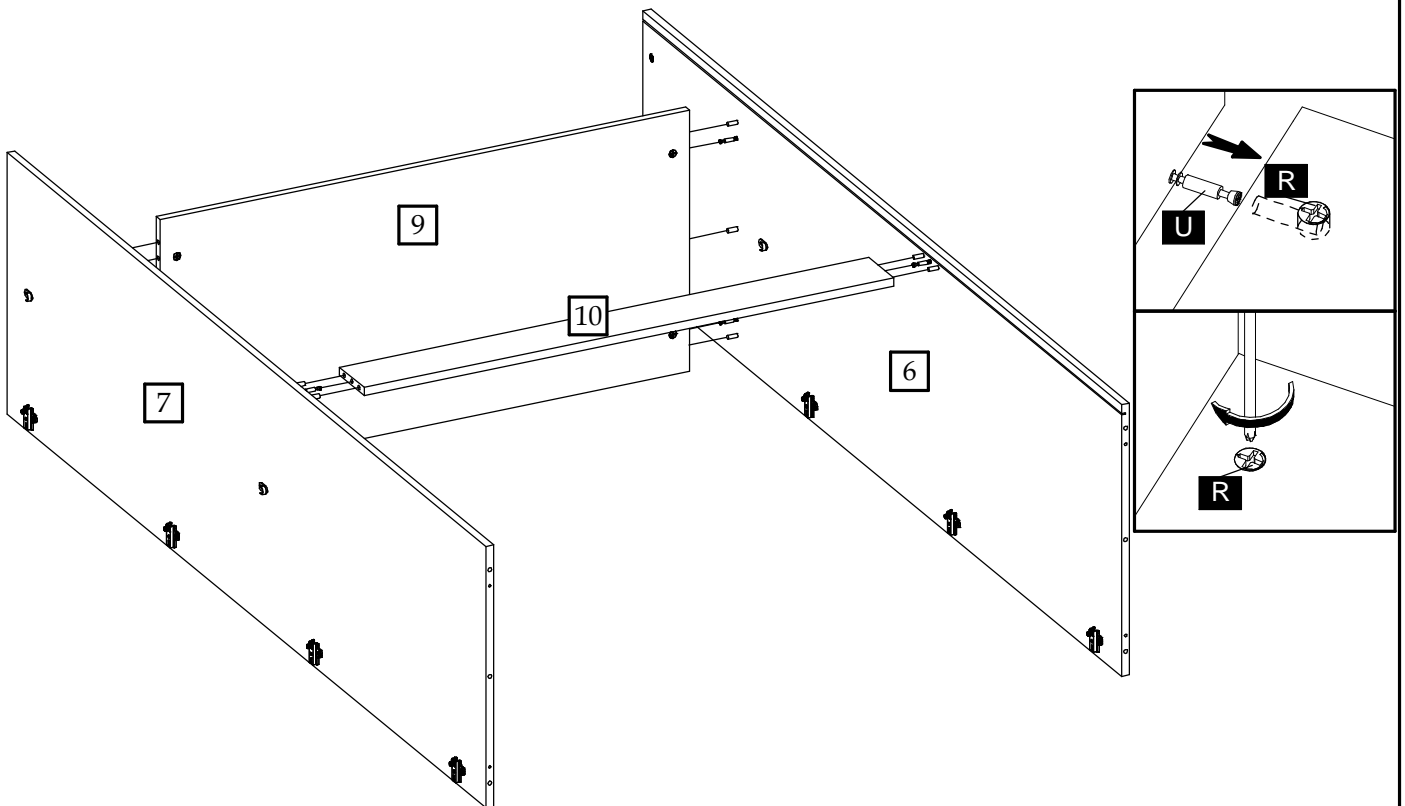
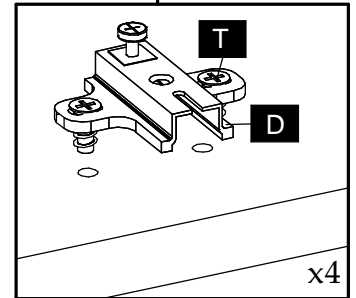
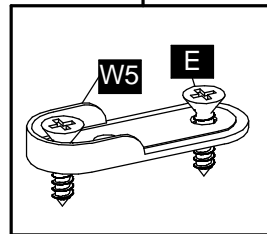
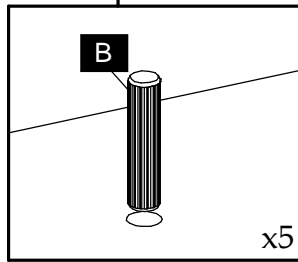

4

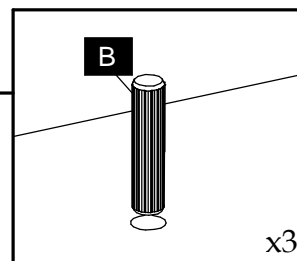
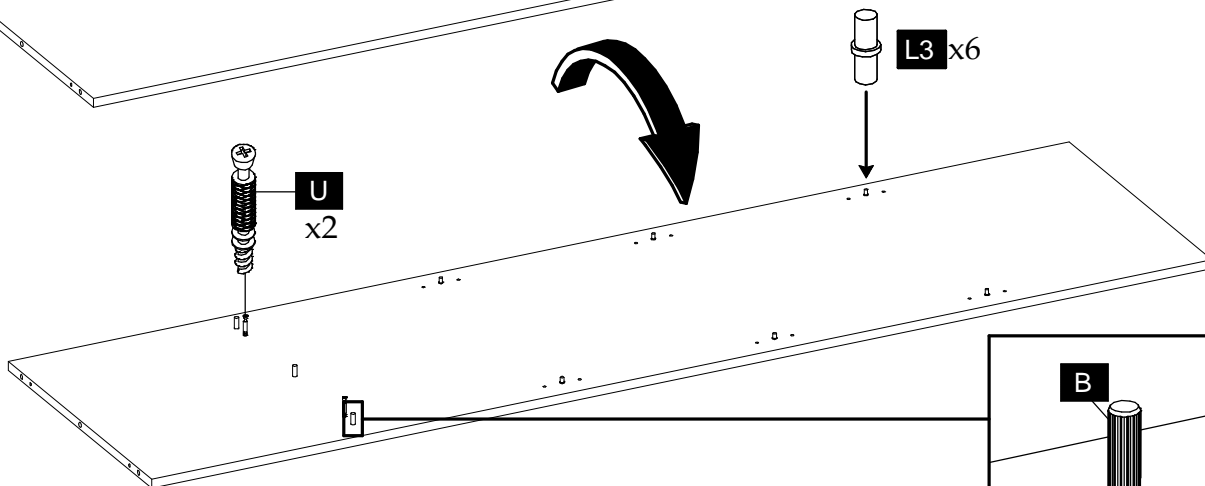
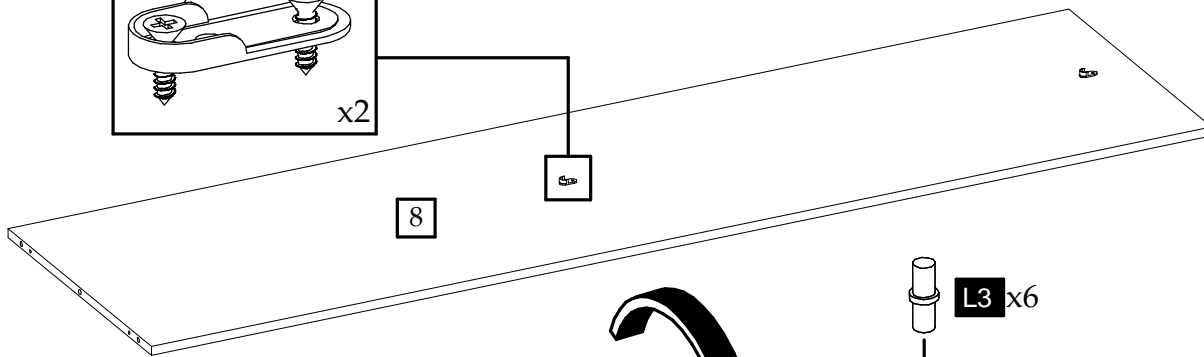
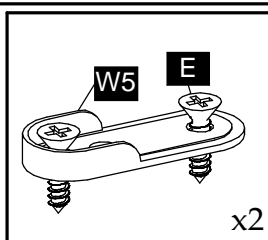

5

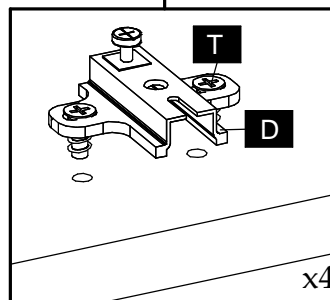
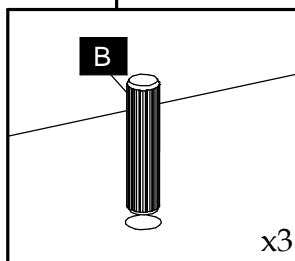
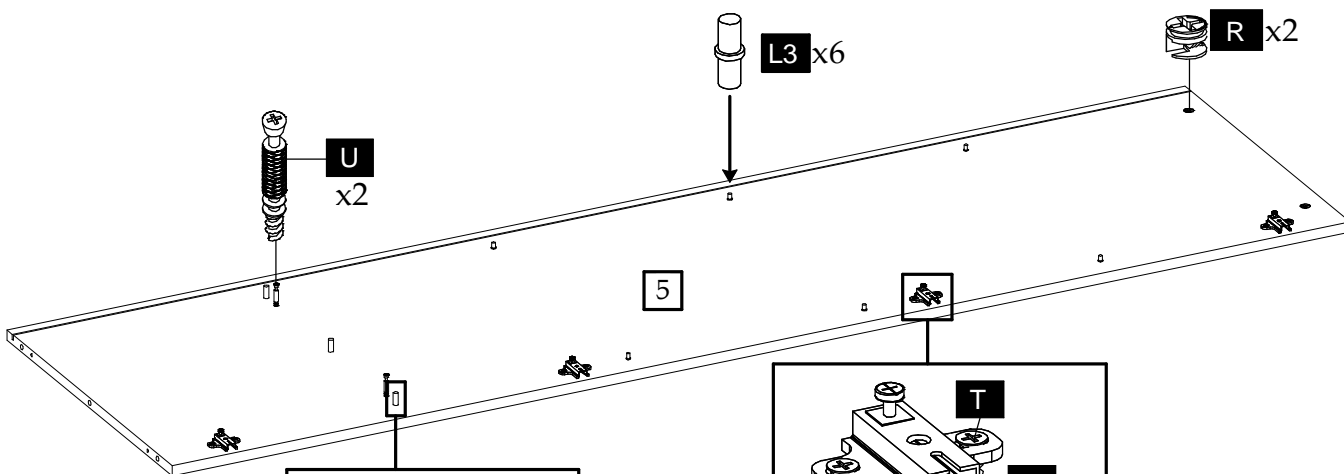
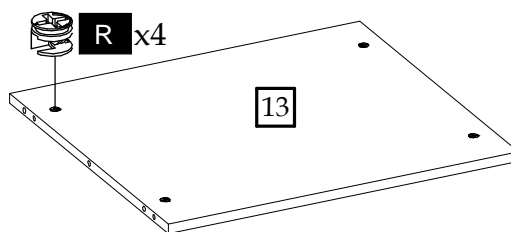

6

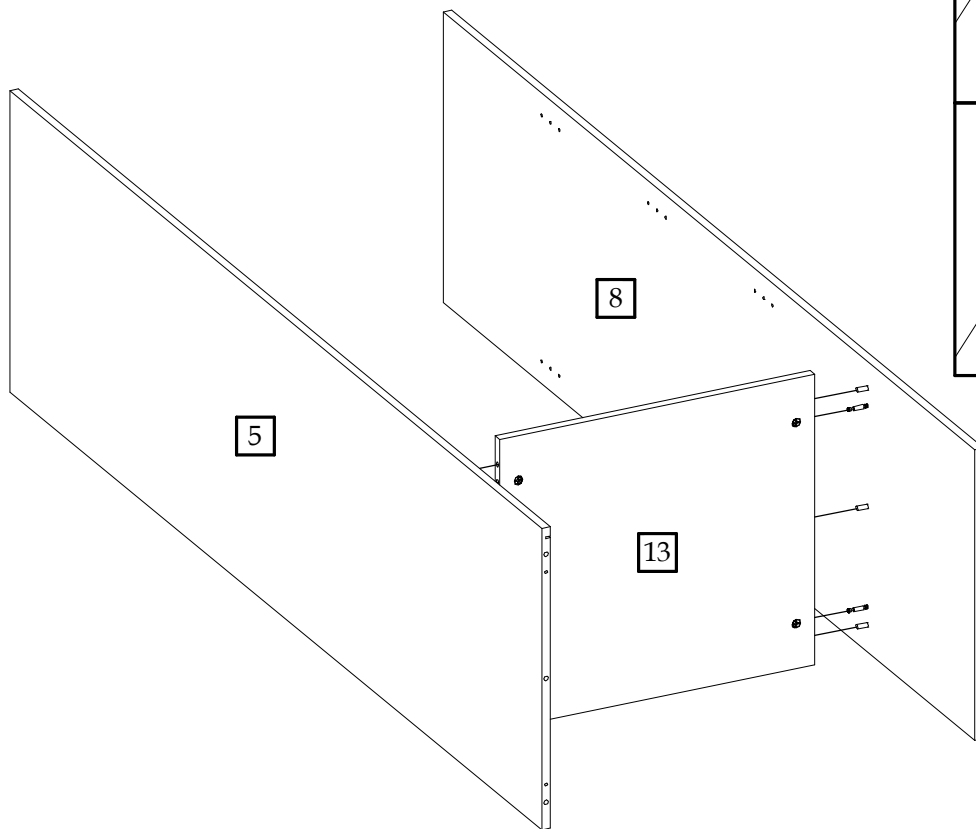

7

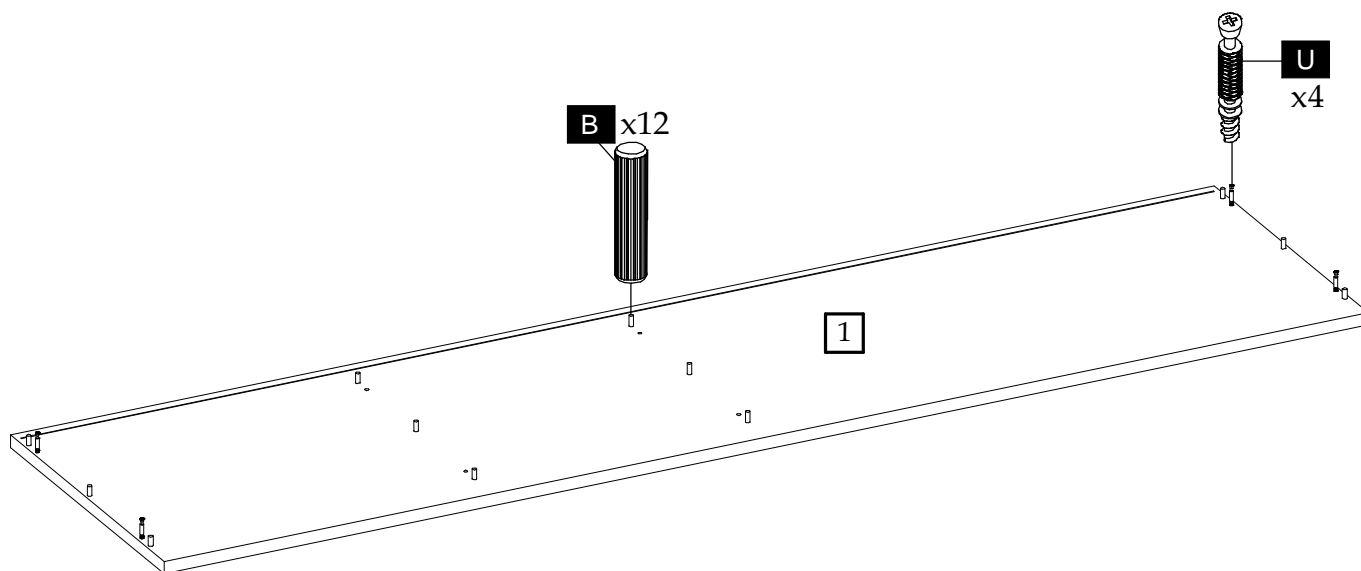



8

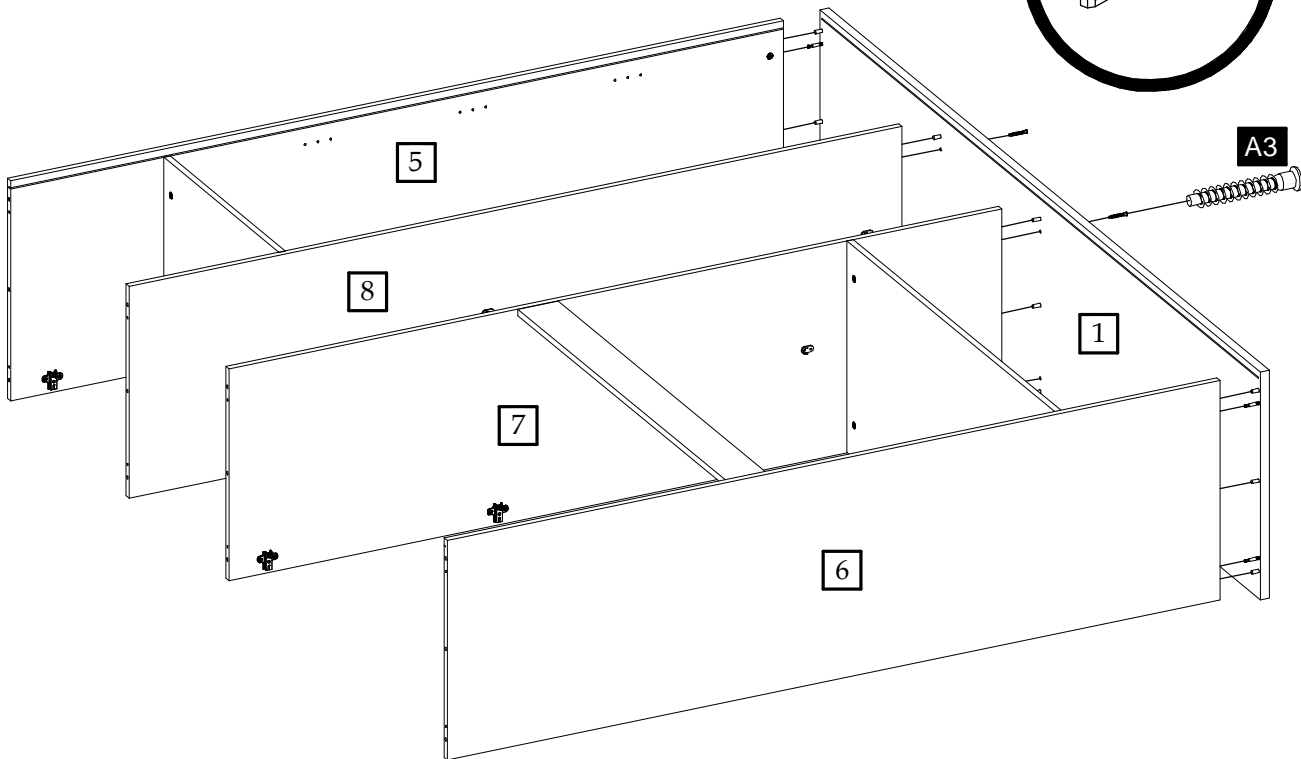

9

