

# VALLES

## Typ R

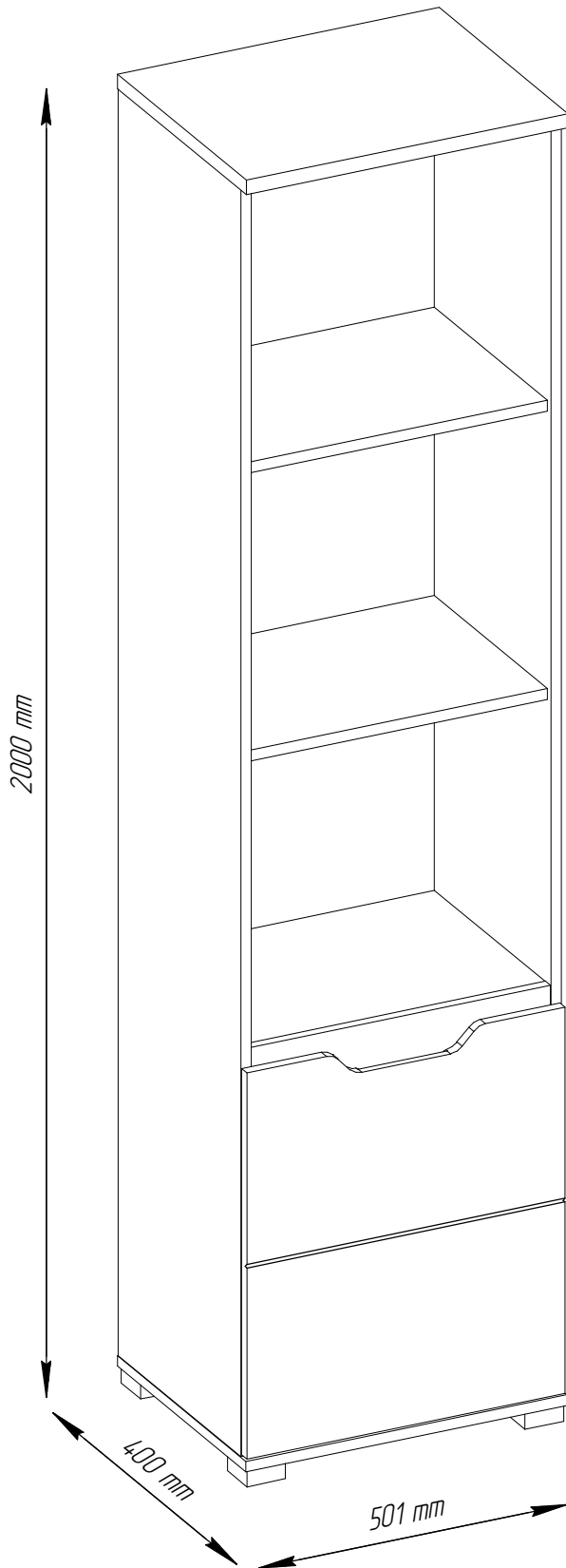

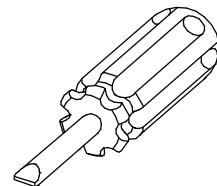

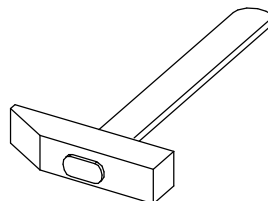
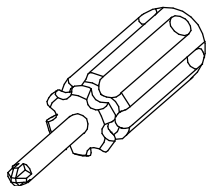
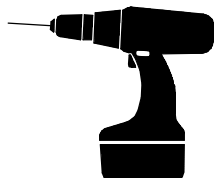
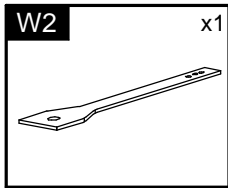
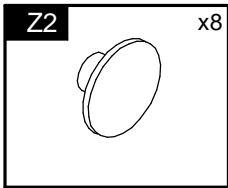
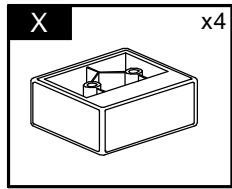
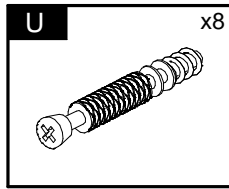
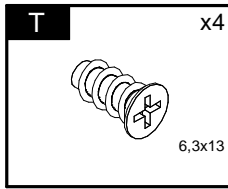
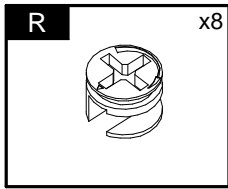
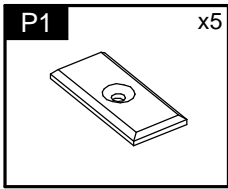
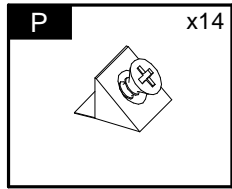
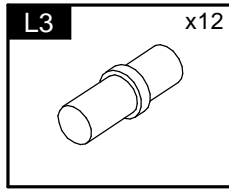
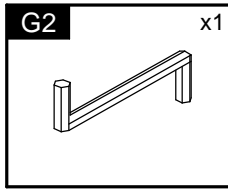
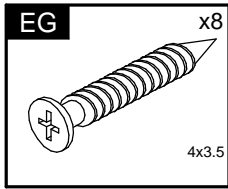
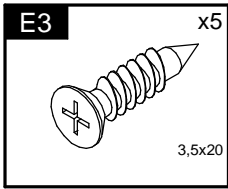
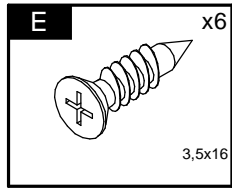
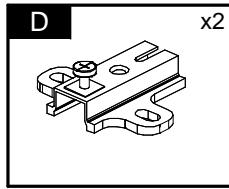
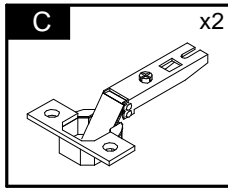
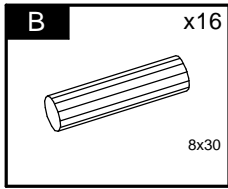
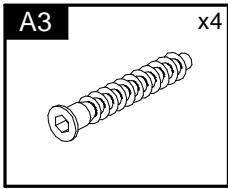

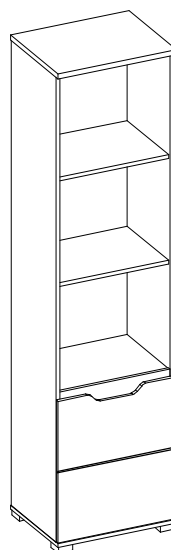

Element symbol	Measurements				Code	Paket
	W	G	T	H		
1	501	400	22	1	1004	1/2
2	501	398.5	16	1	1001	1/2
3	467	344.5	16	1	1006	1/2
4	467	77	16	1	1018	1/2
5	1937	381	16	1	1002	1/2
6	1937	381	16	1	1003	1/2
7	461	351	16	3	N/A	1/2
8	620	480	2.5	1	N/A	2/2
9	1330	480	2.5	1	N/A	1/2
10	590	496	16	1	3015	2/2

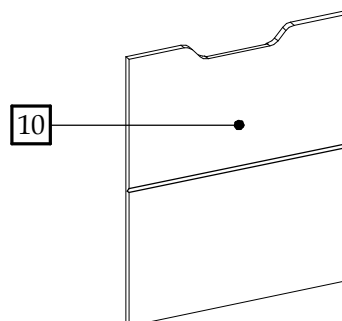
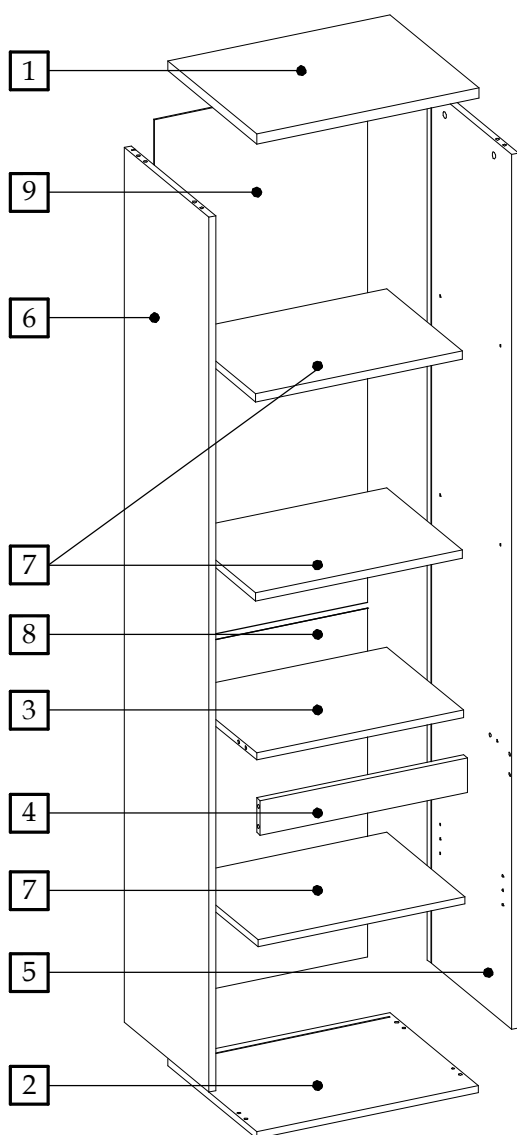

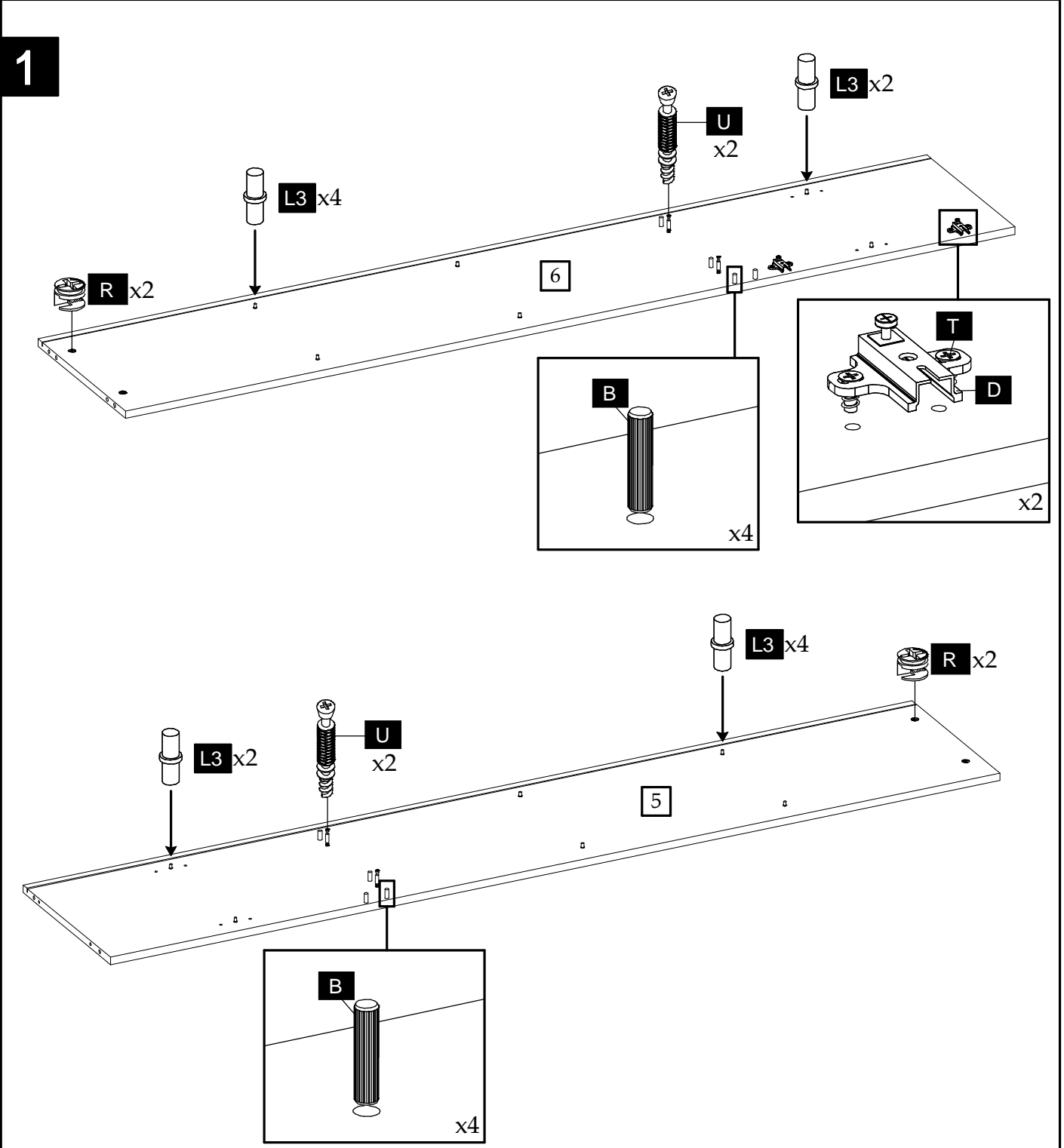

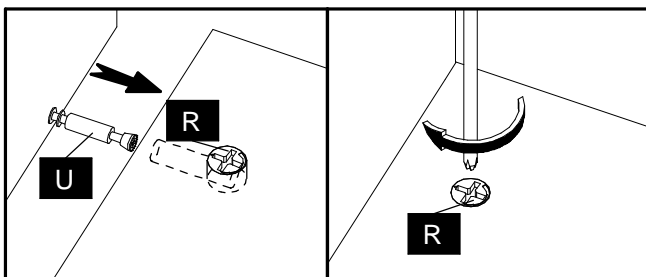
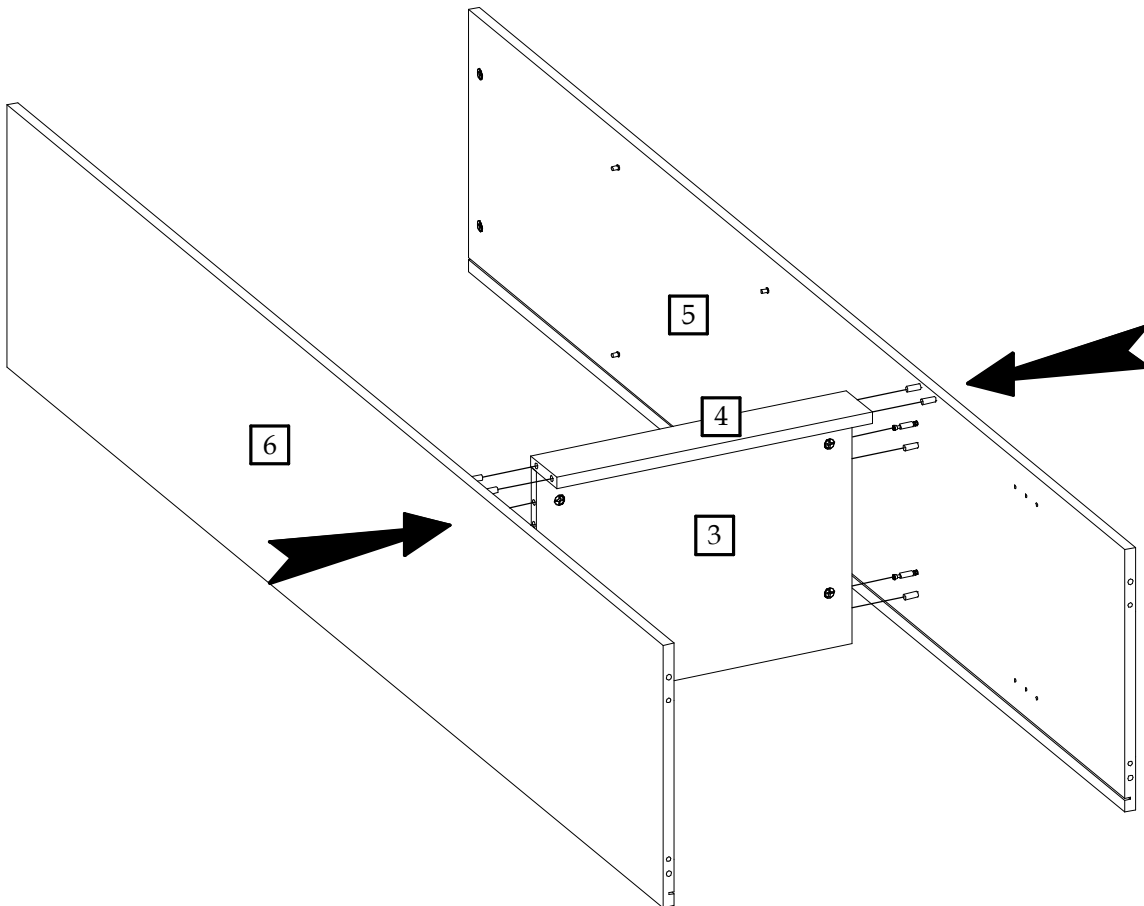
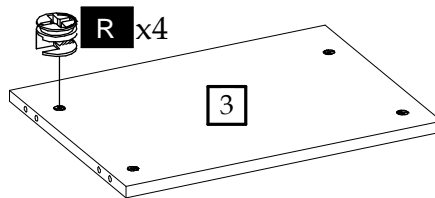

3

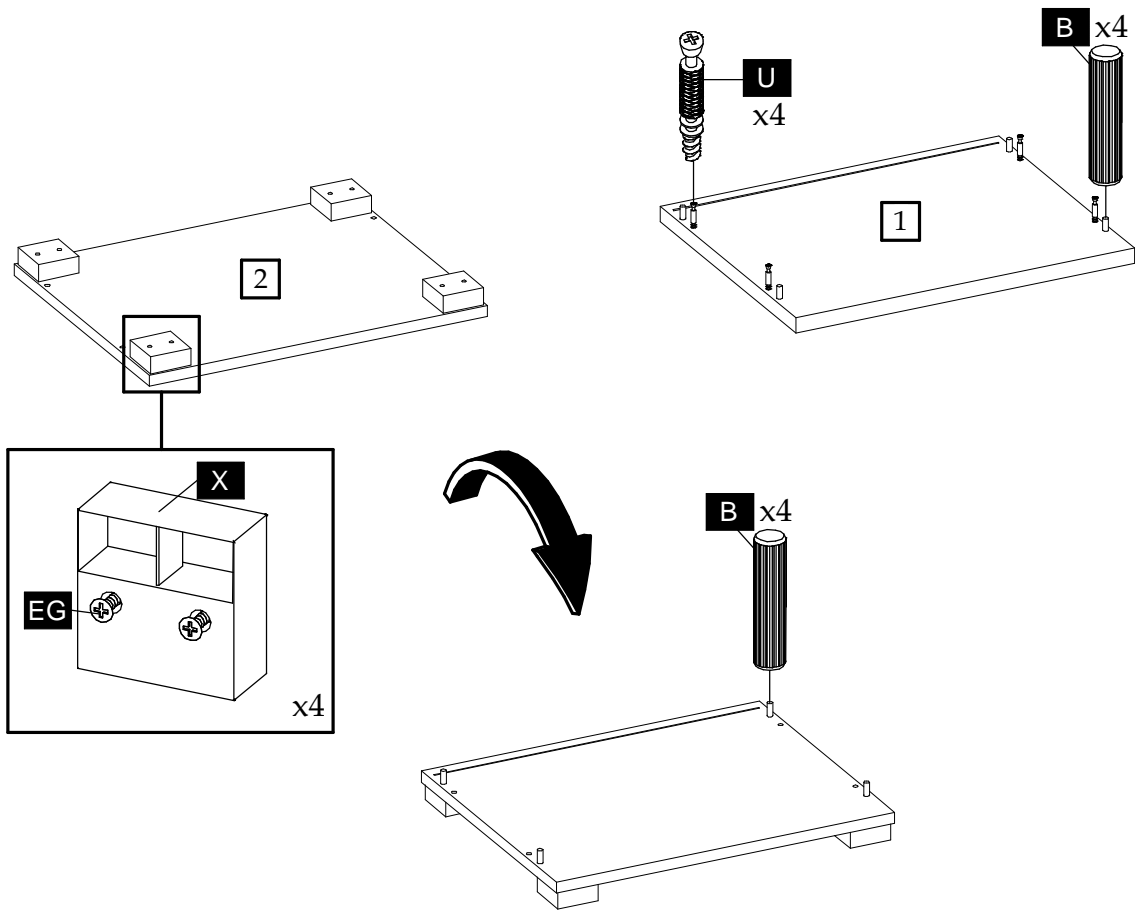

4

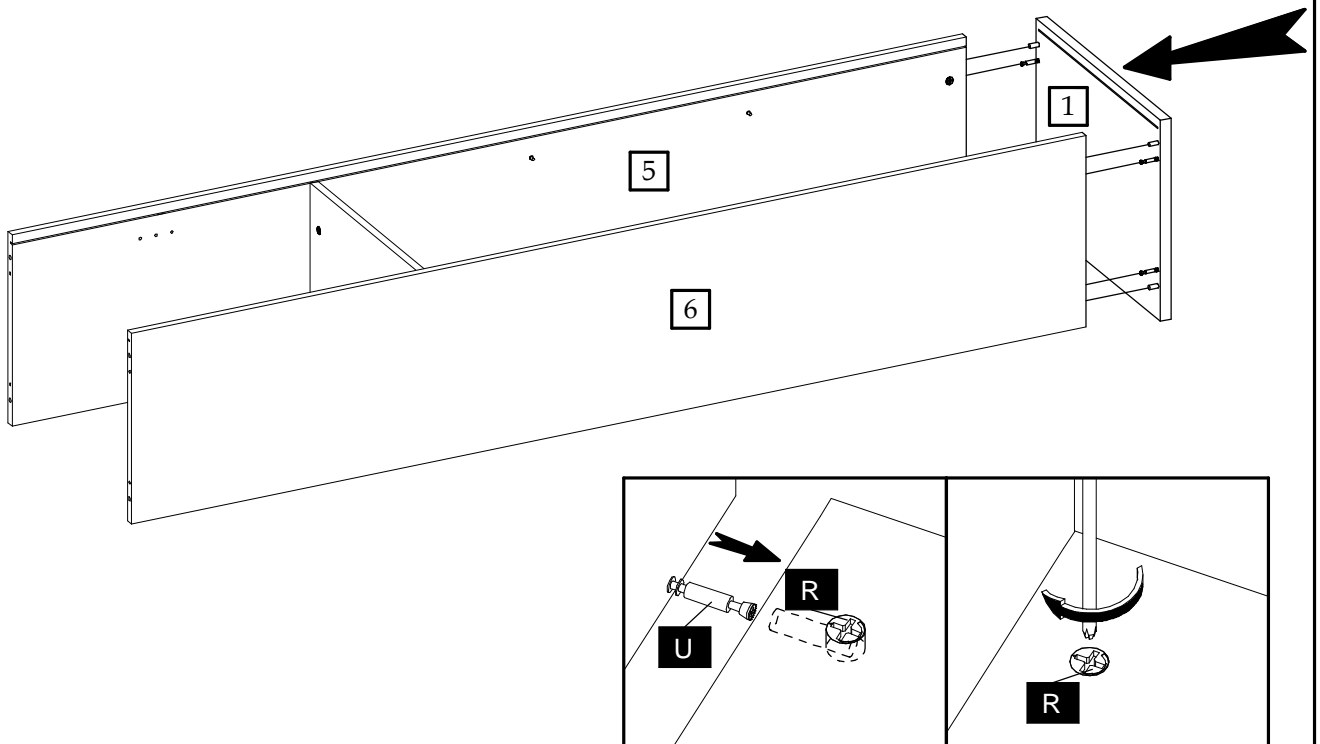

5

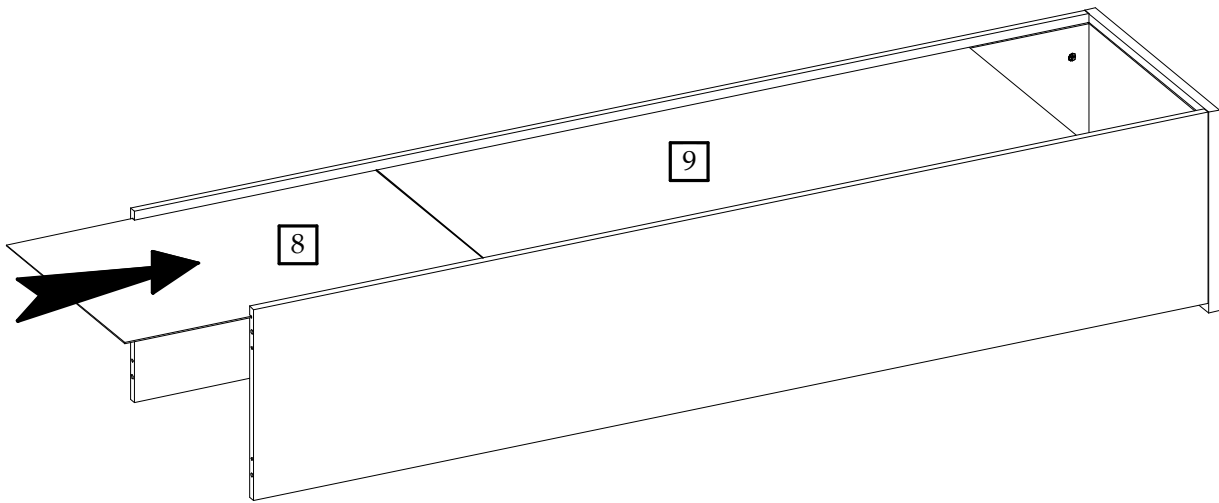

6

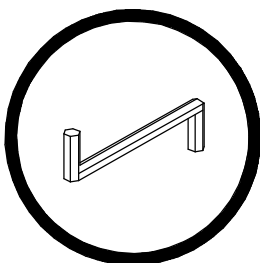
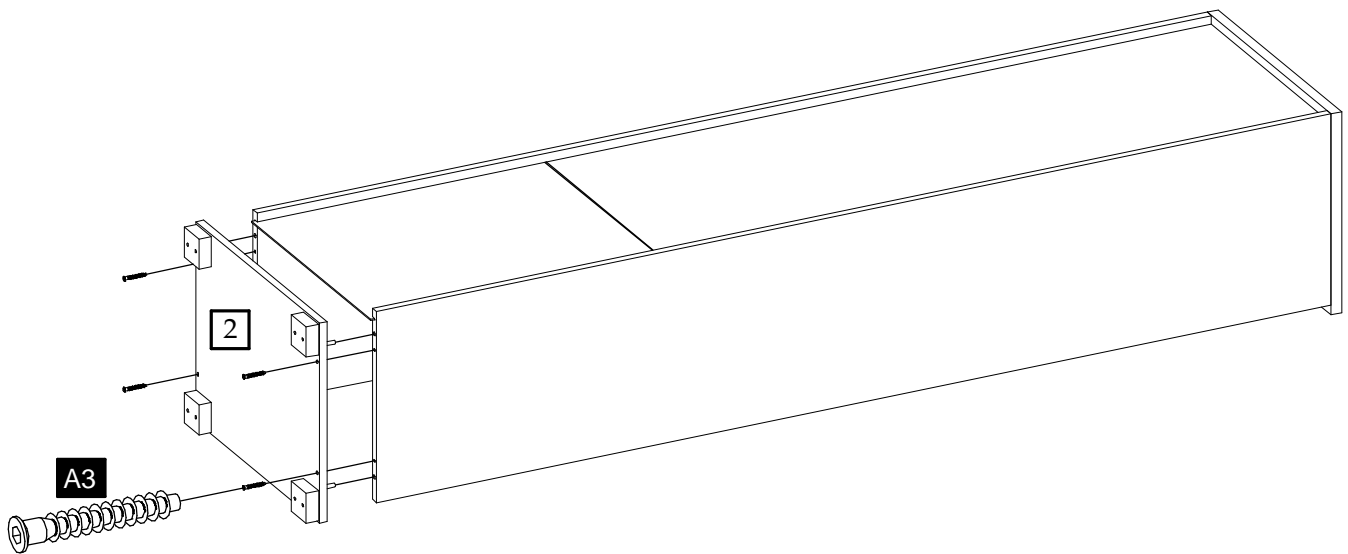



7

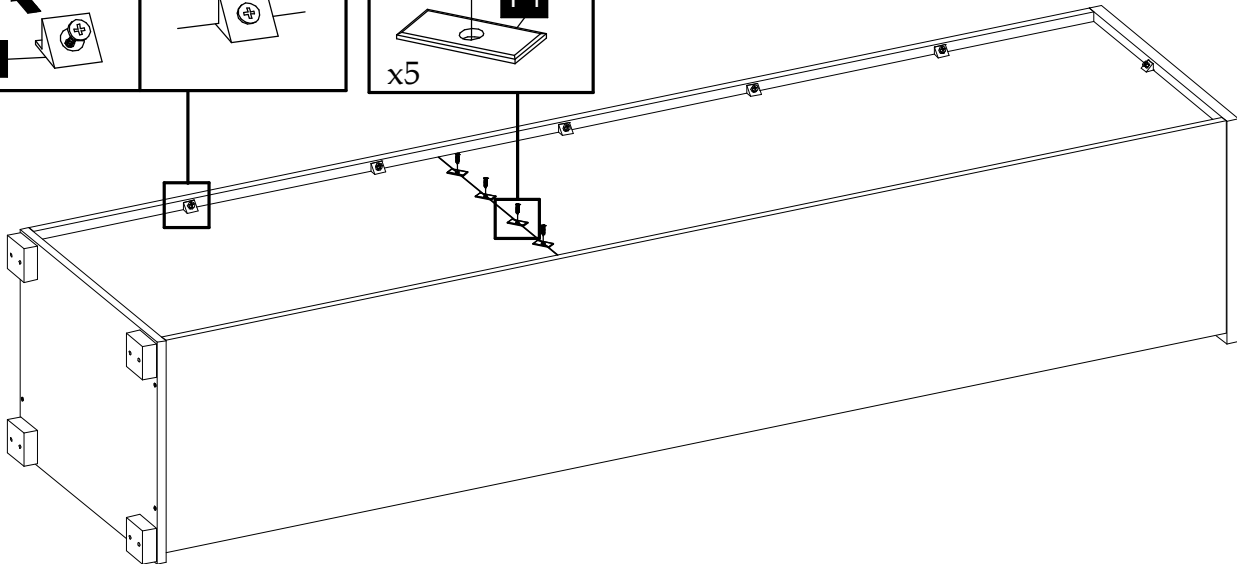
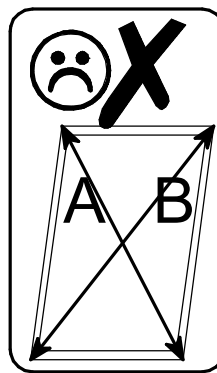
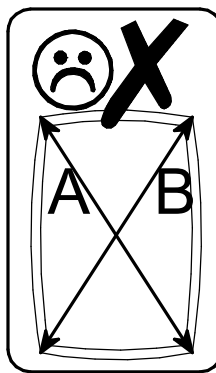
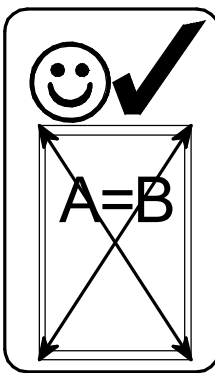
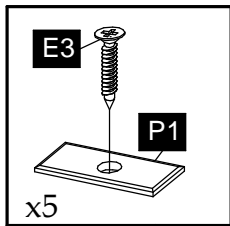
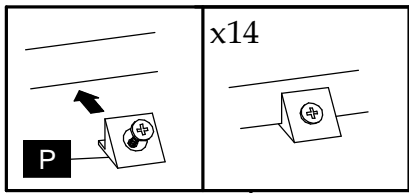

8

