

# VALLES

Typ W

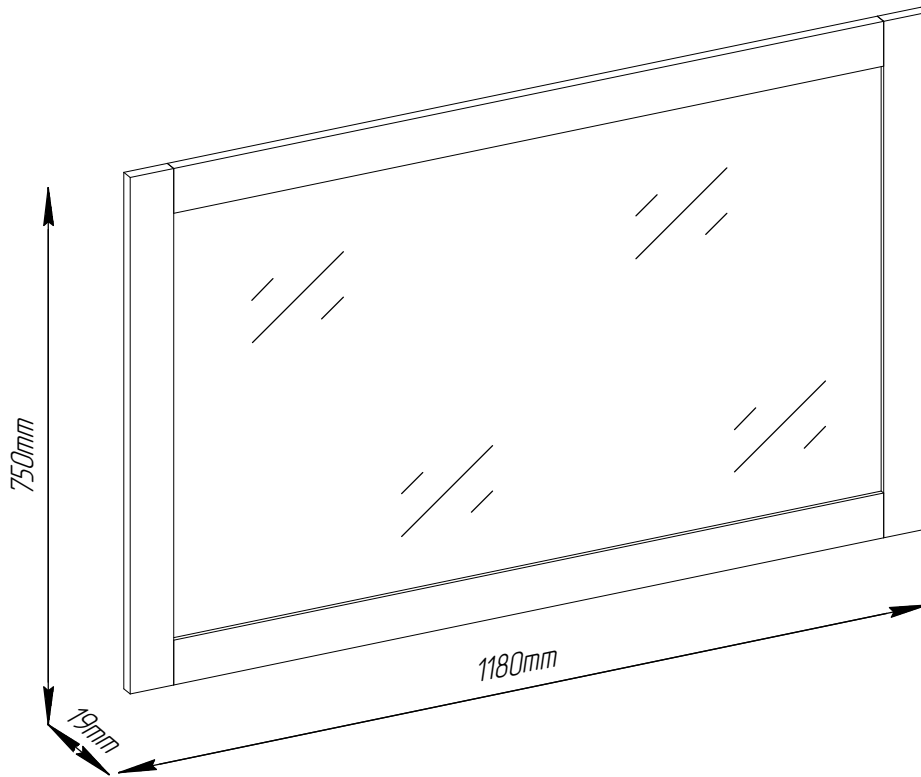

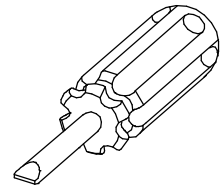

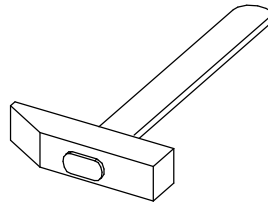
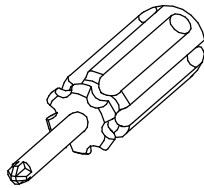
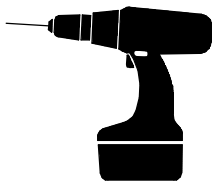
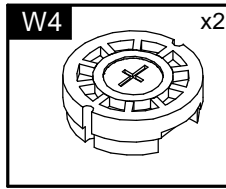
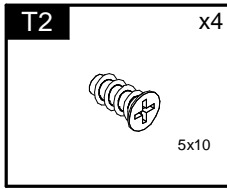
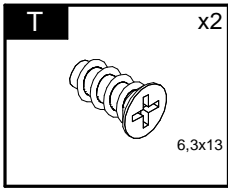

Element symbol	Measurements				Code	Paket
1	1180	750	19	1	1001	1/1

