

VOYAGE T05

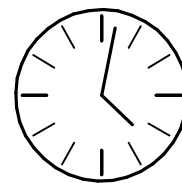

30 min

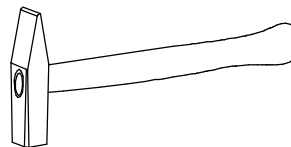

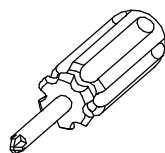
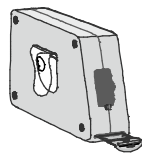
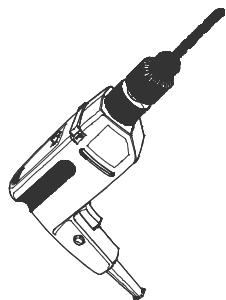
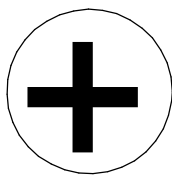
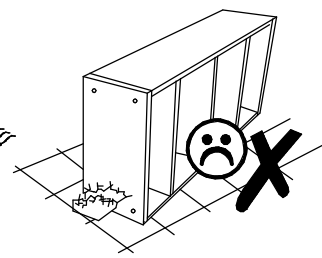
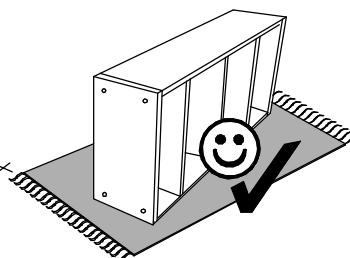
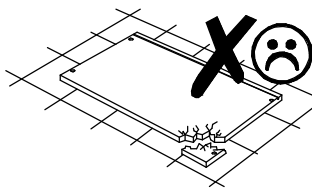
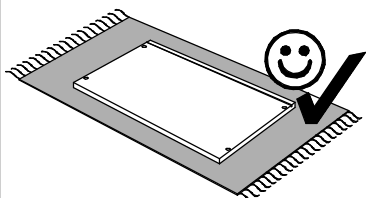
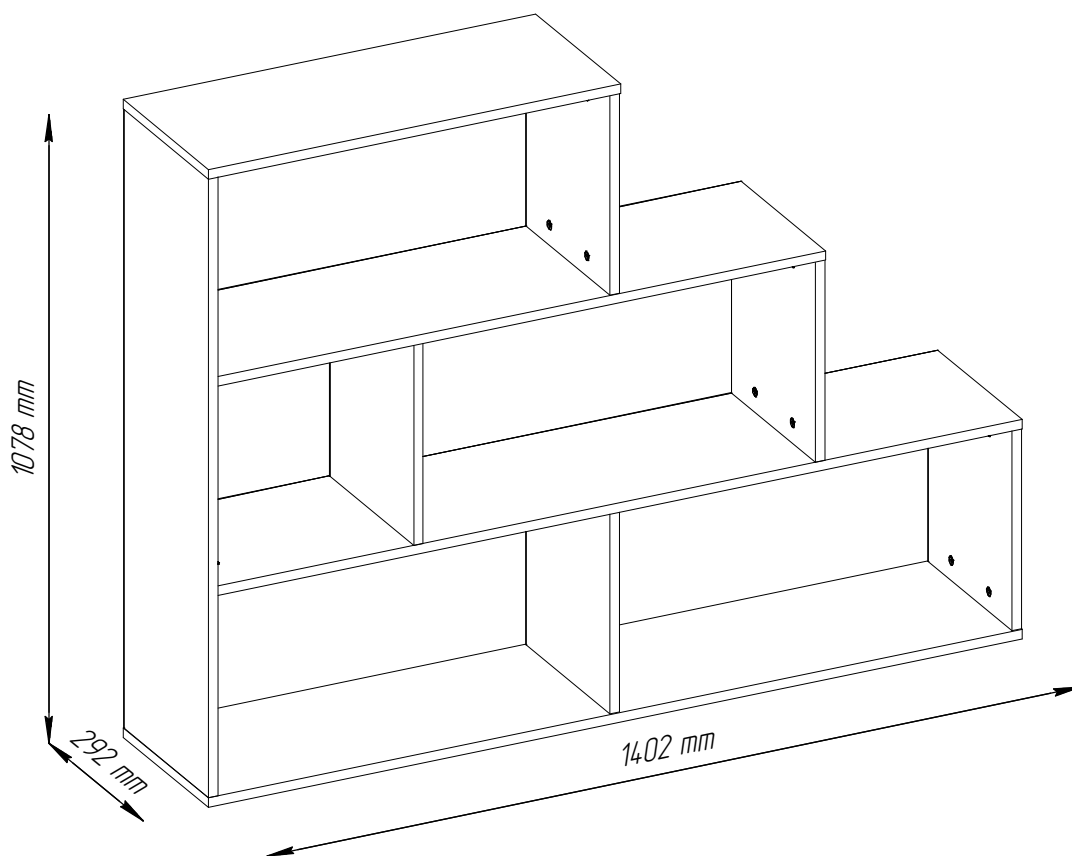
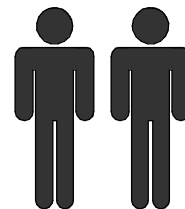
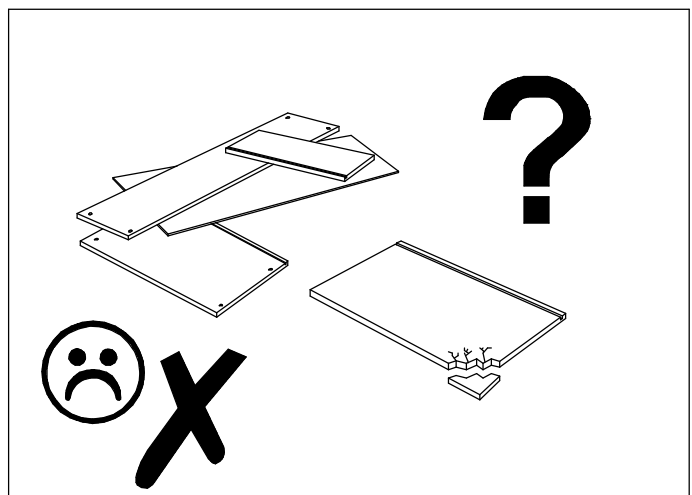
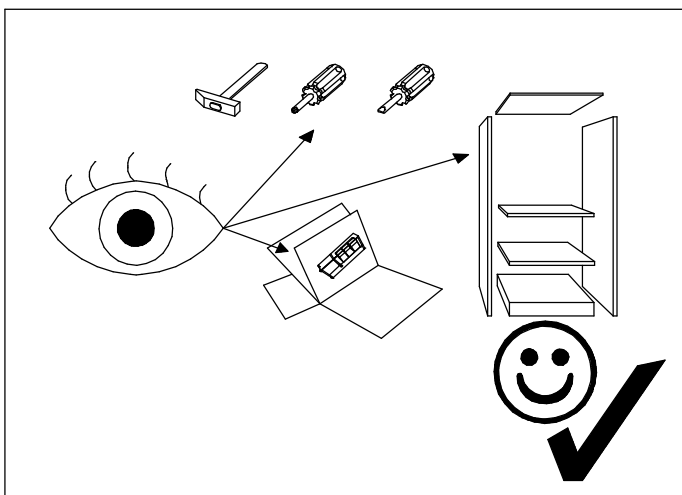
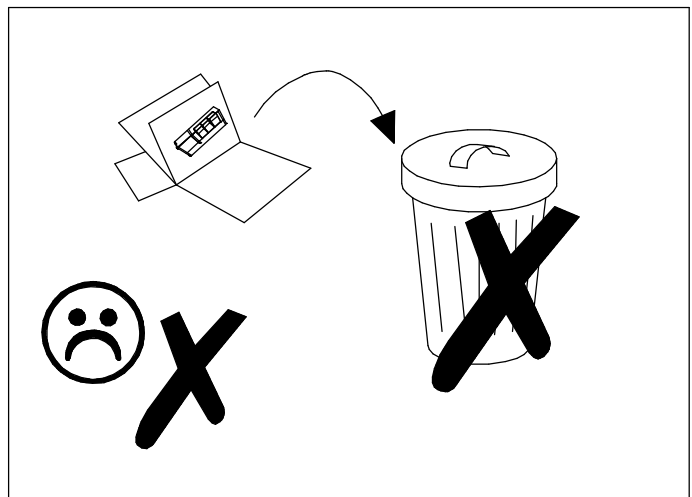
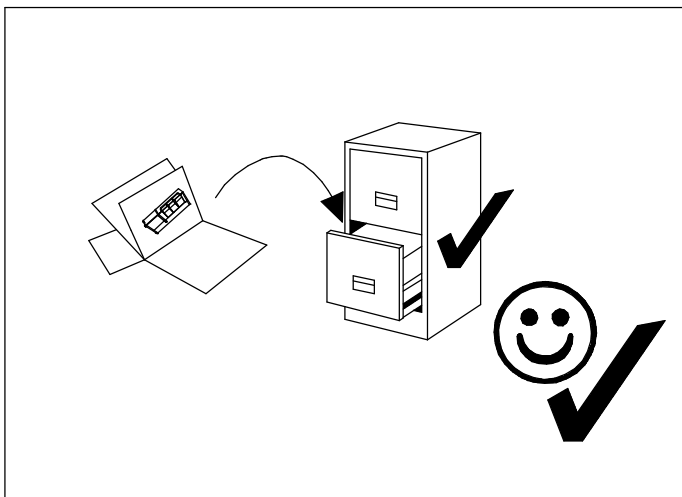
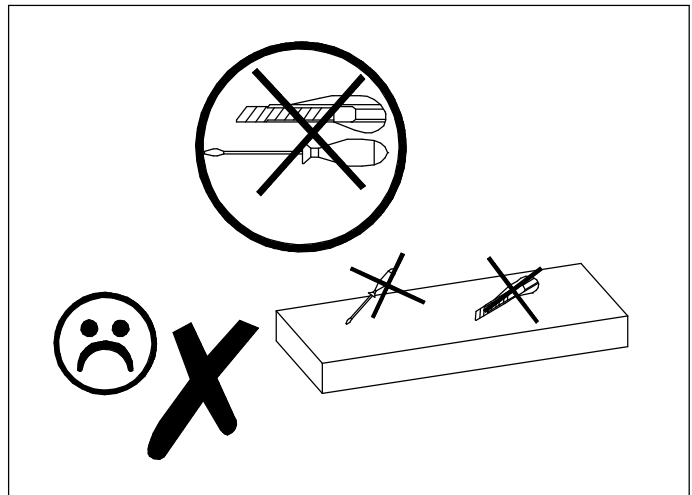
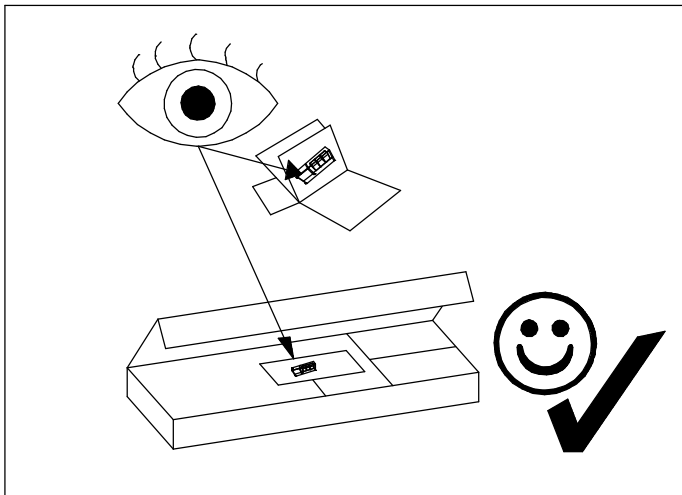

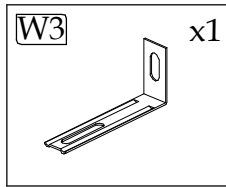
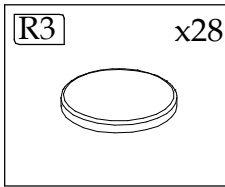
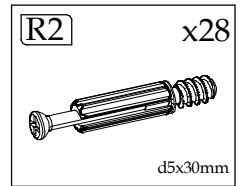
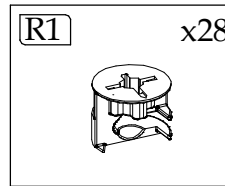
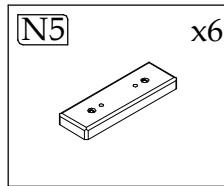
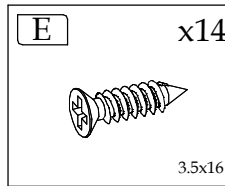
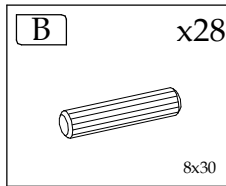
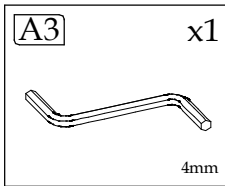

Element symbol	Measurements				Code	Paket
	1	2	3	4		
1	1046	291	16	1	1001	1/1
2	1402	292	16	1	1003	1/1
3	1385	290	16	1	1024	1/1
4	1047	290	16	1	1026	1/1
5	710	292	16	1	1004	1/1
6	338	289	16	1	1025	1/1
7	338	289	16	1	1021	1/1
8	338	289	16	1	1022	1/1
9	338	289	16	1	1027	1/1
10	338	289	16	1	1023	1/1

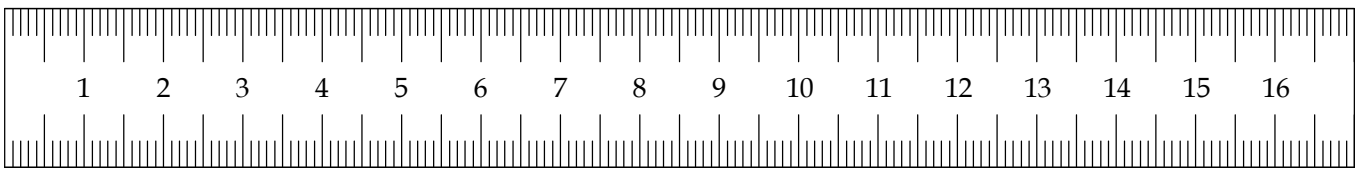
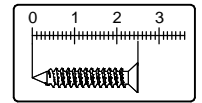
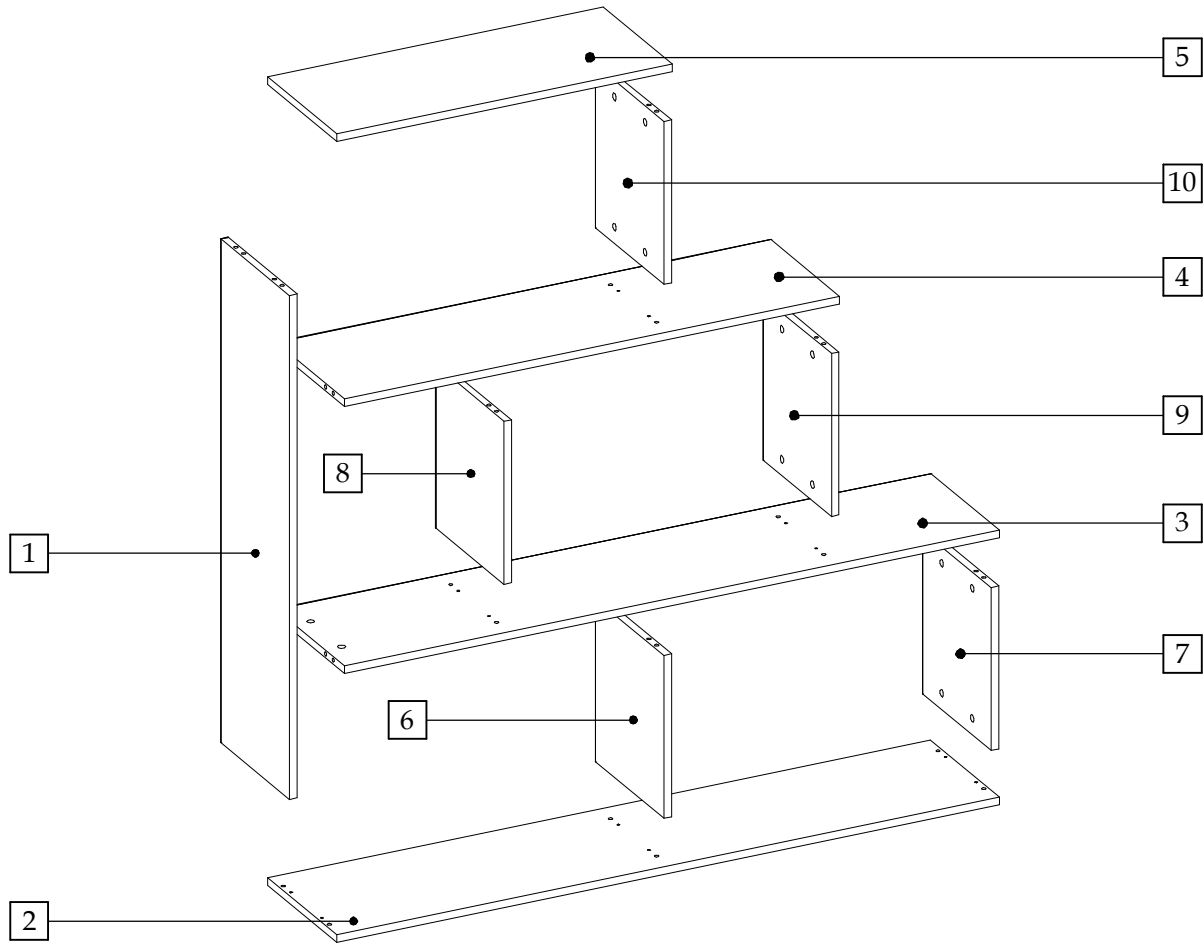

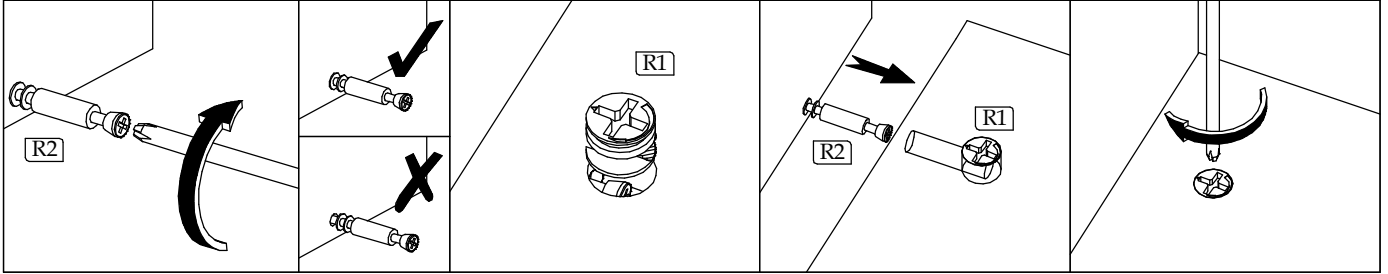

► 1

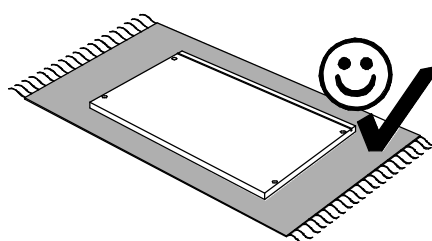
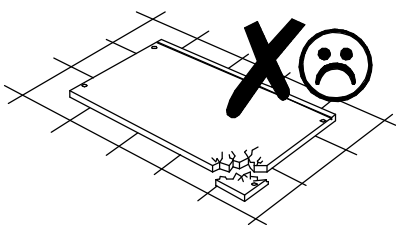
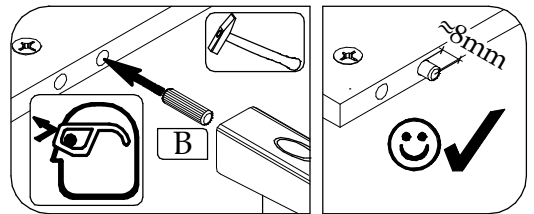
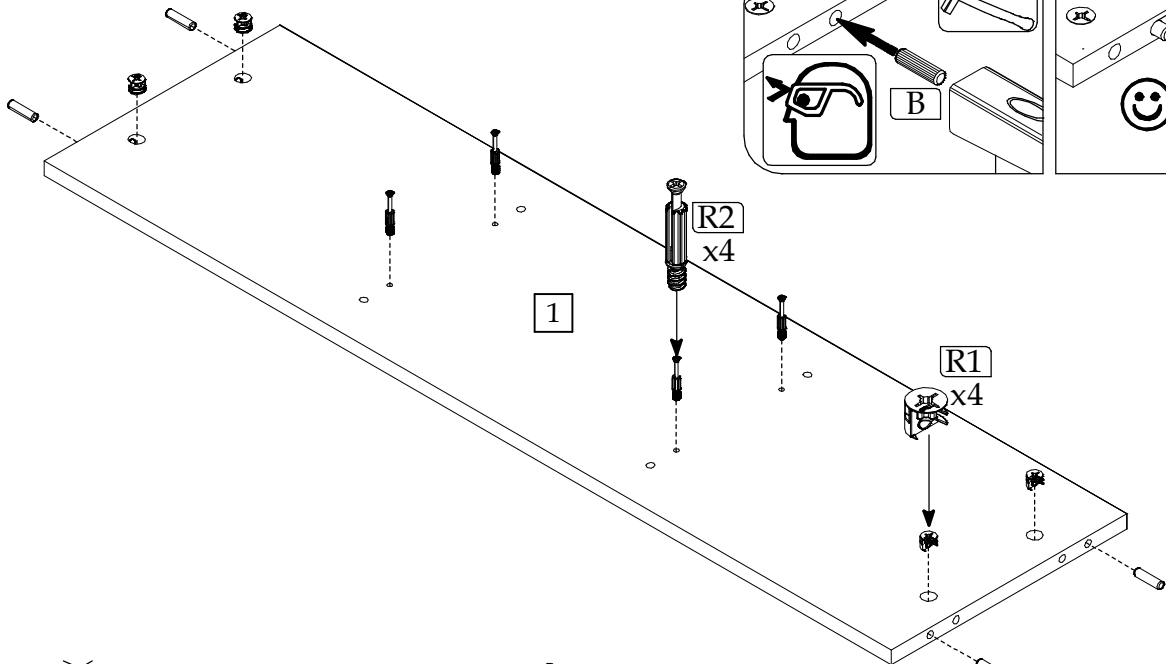
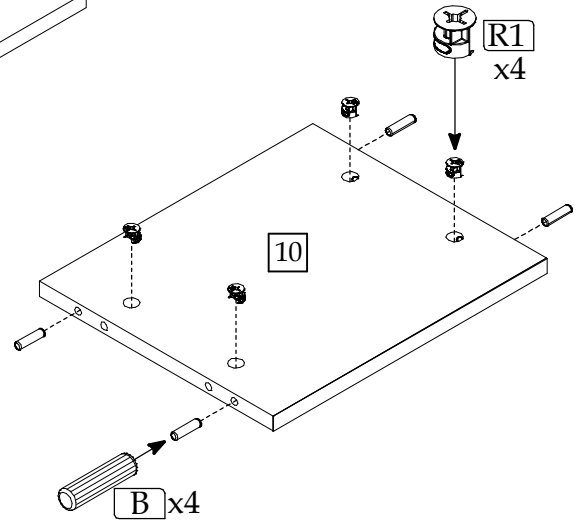
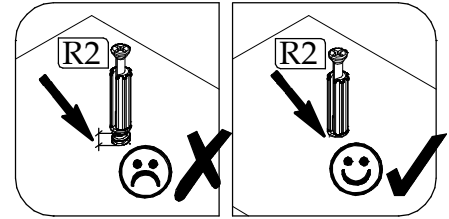
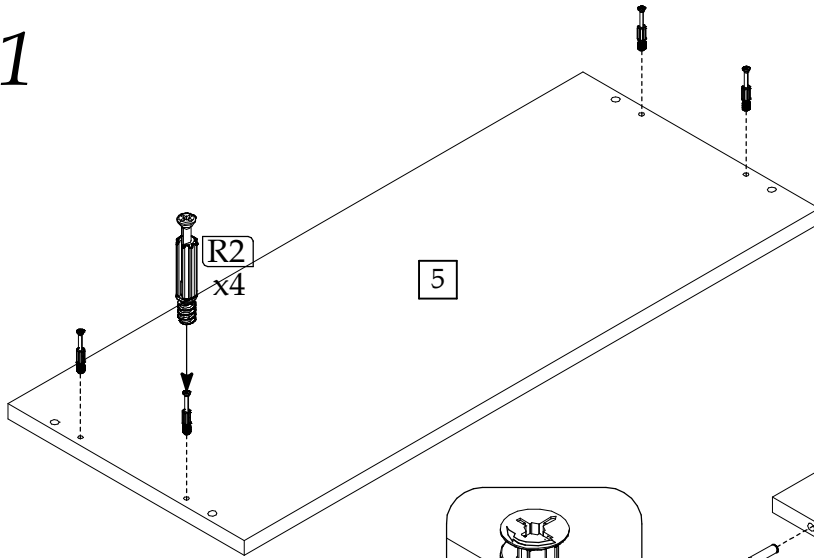

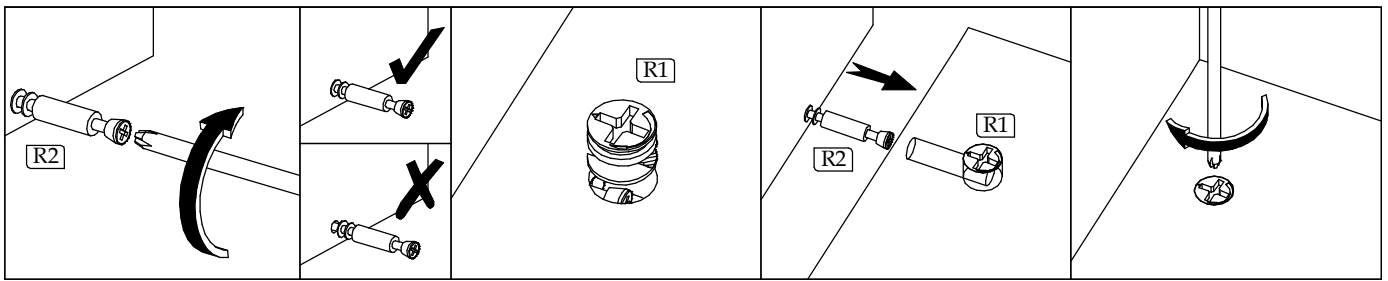

▶ 2

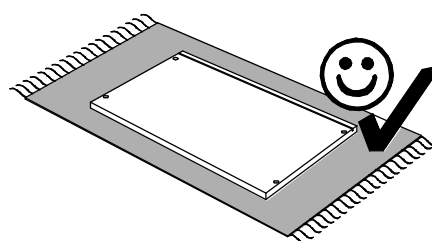
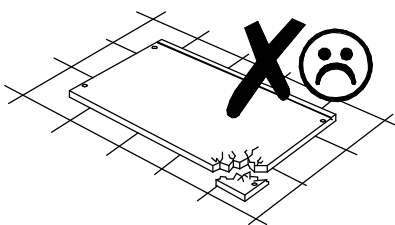
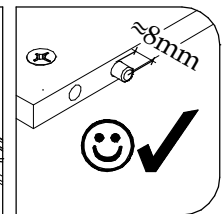
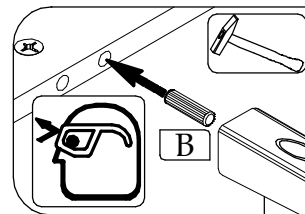
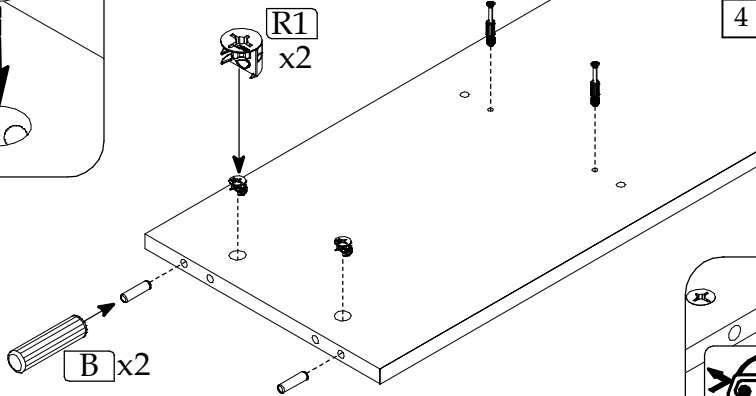
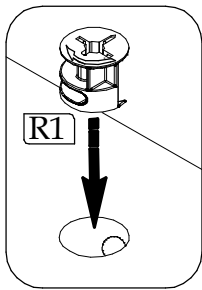
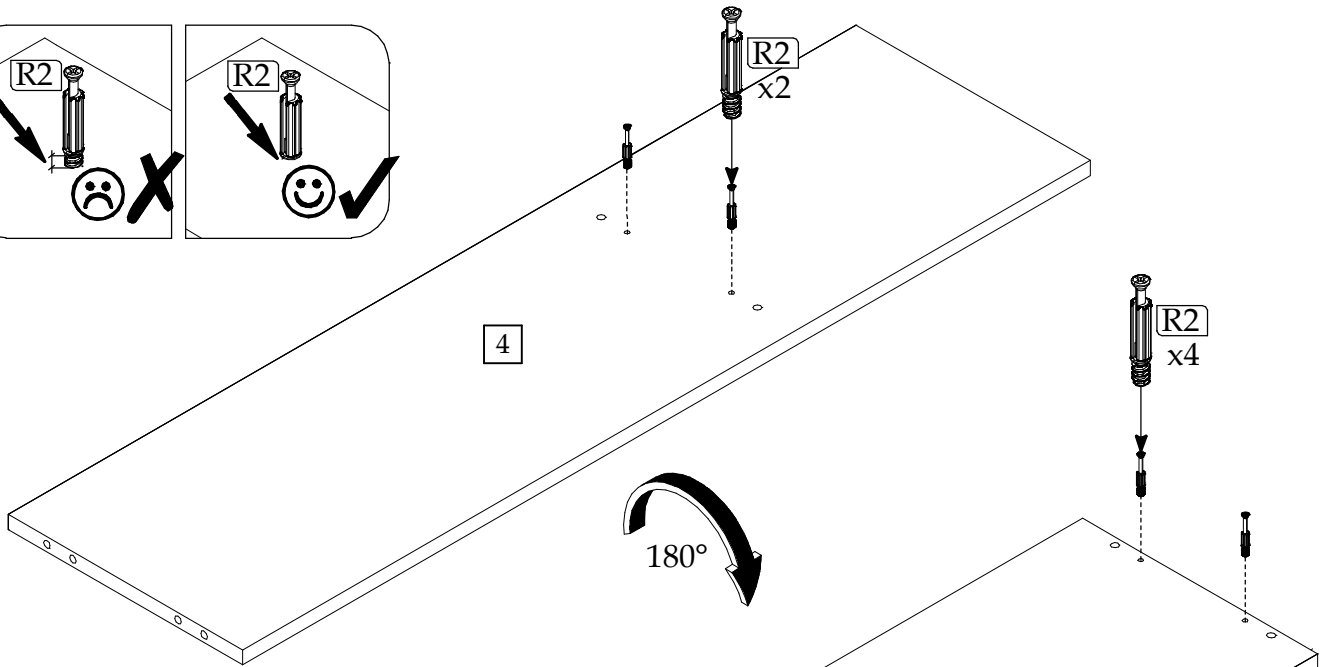
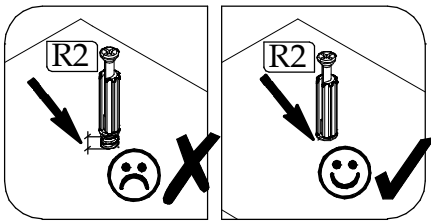

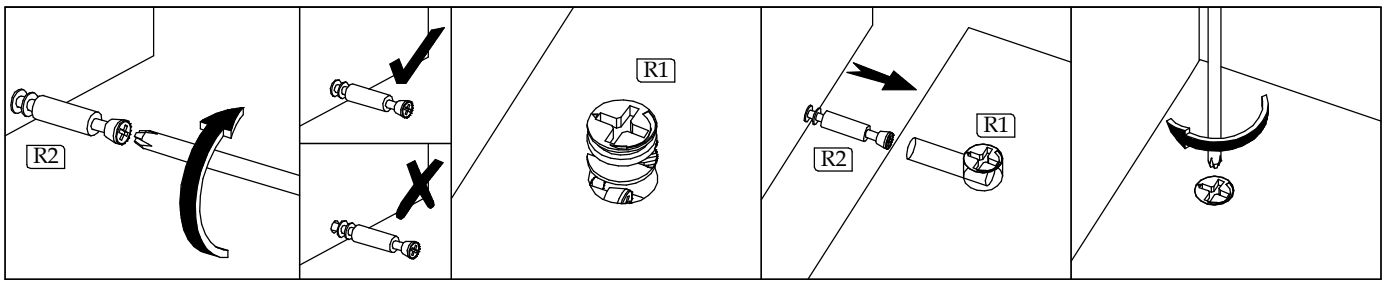

3

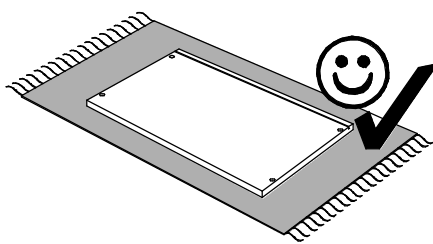
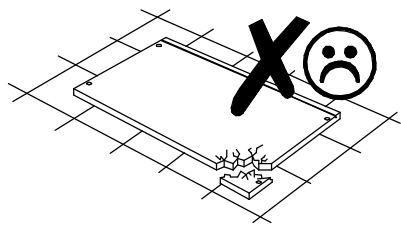
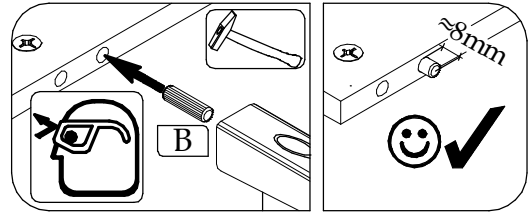
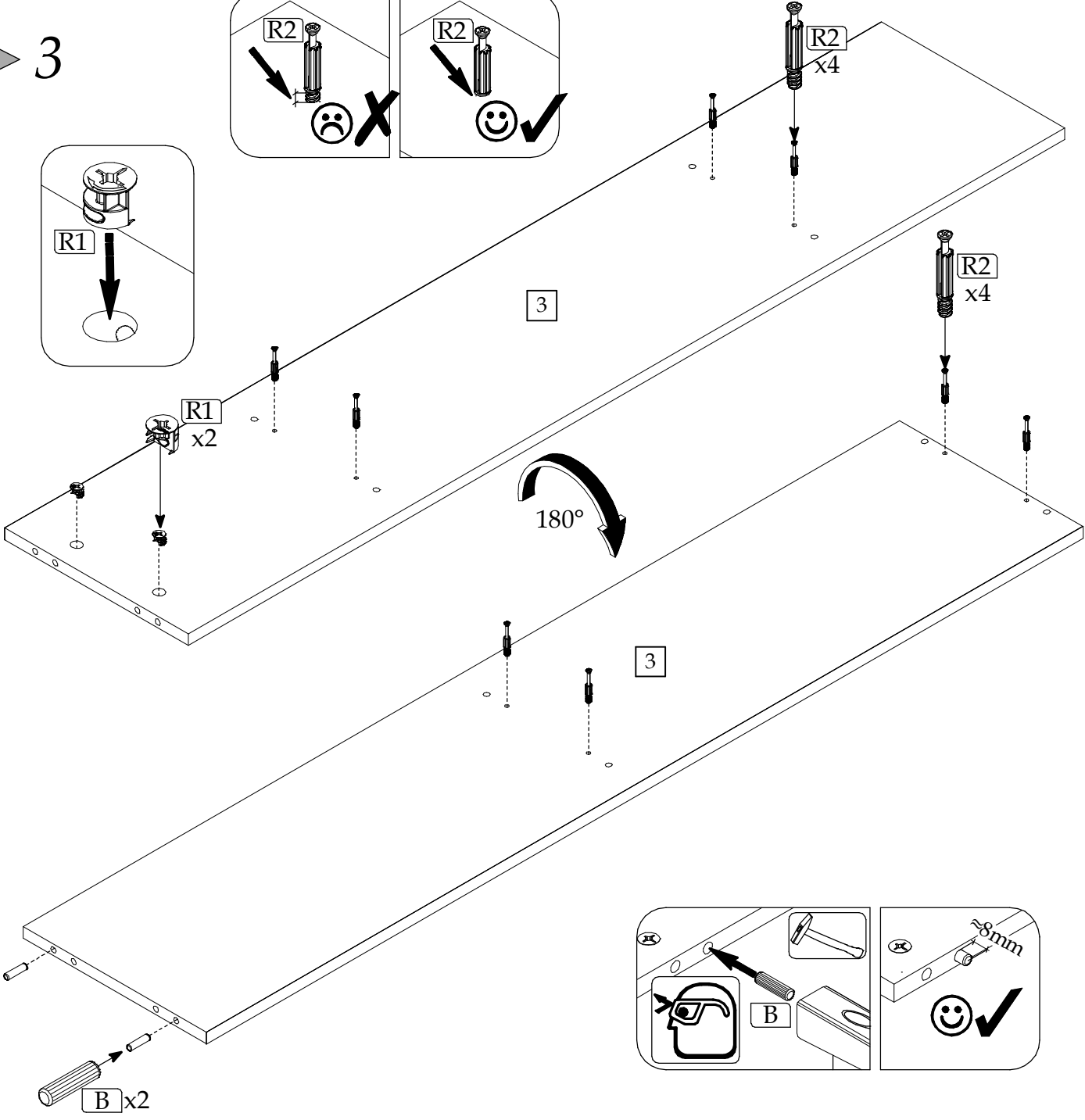
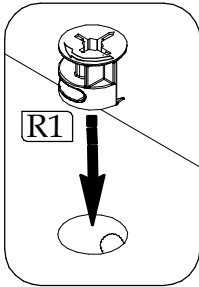
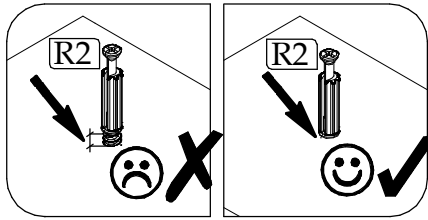

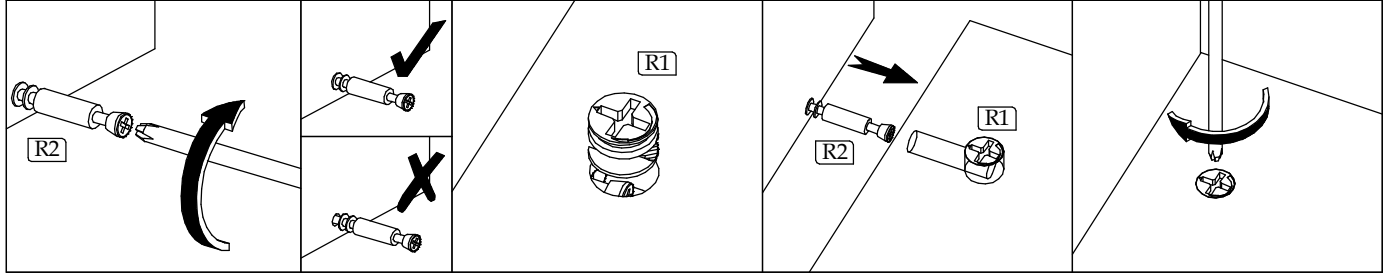

▶ 4

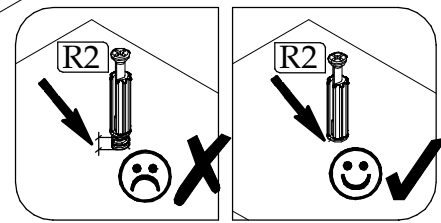
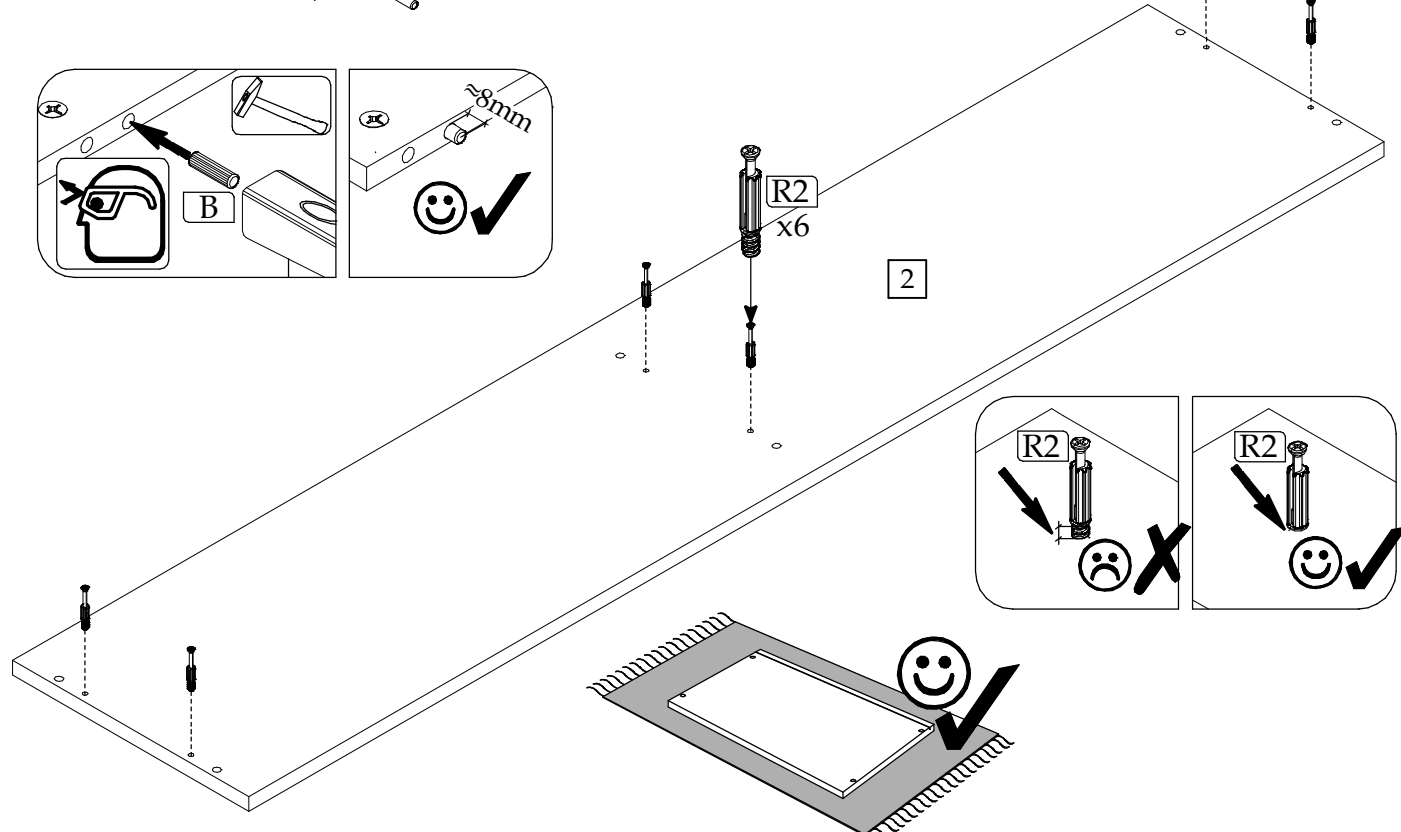
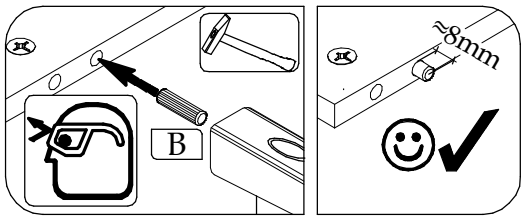
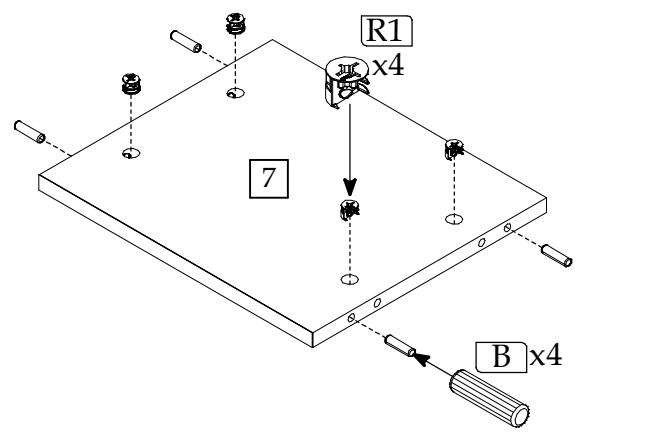
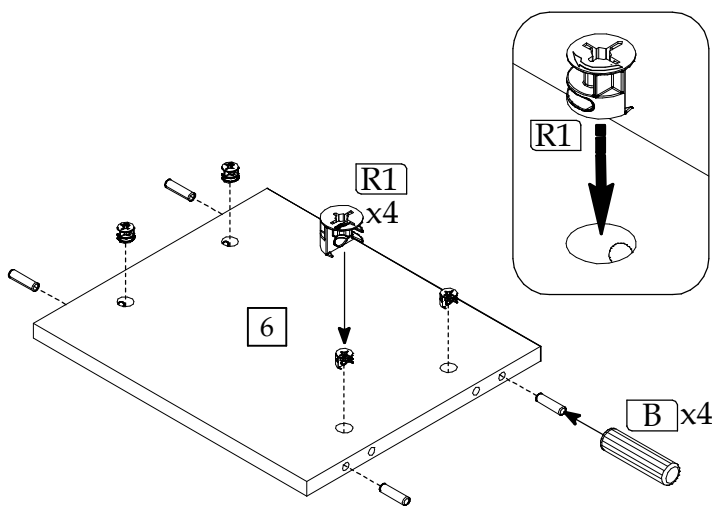
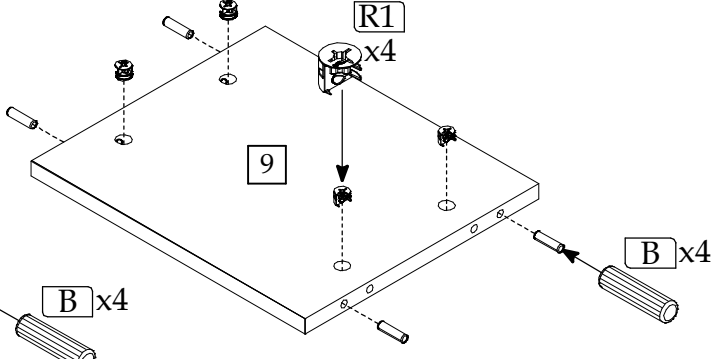
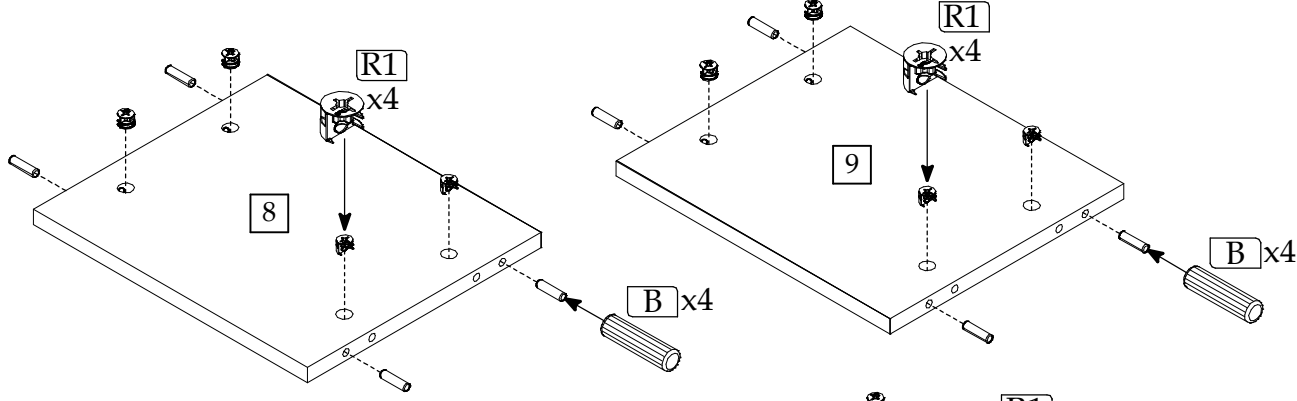

▶ 5

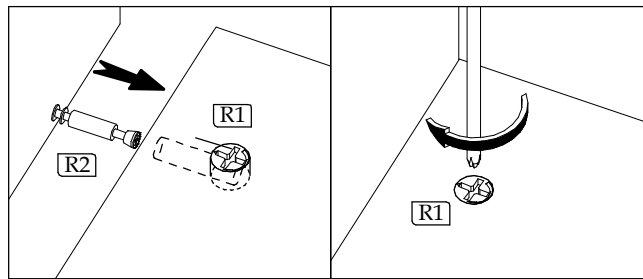
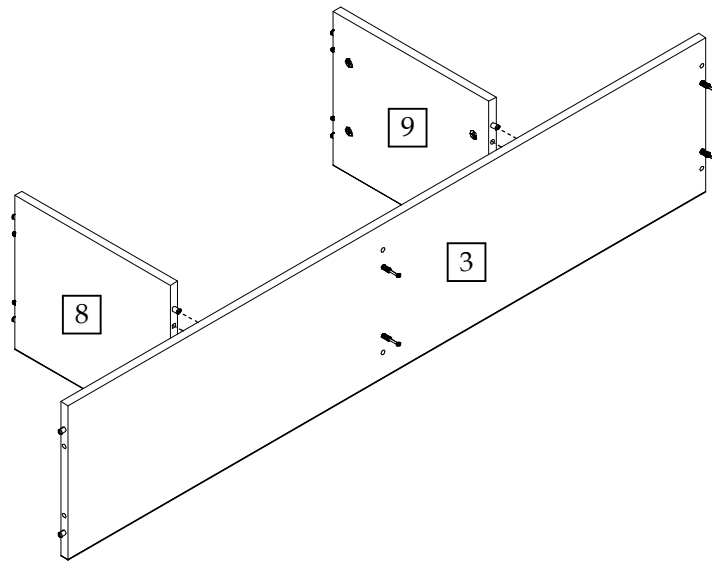

▶ 6

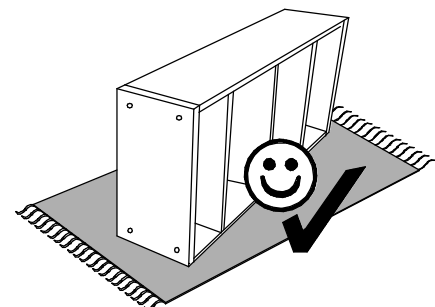
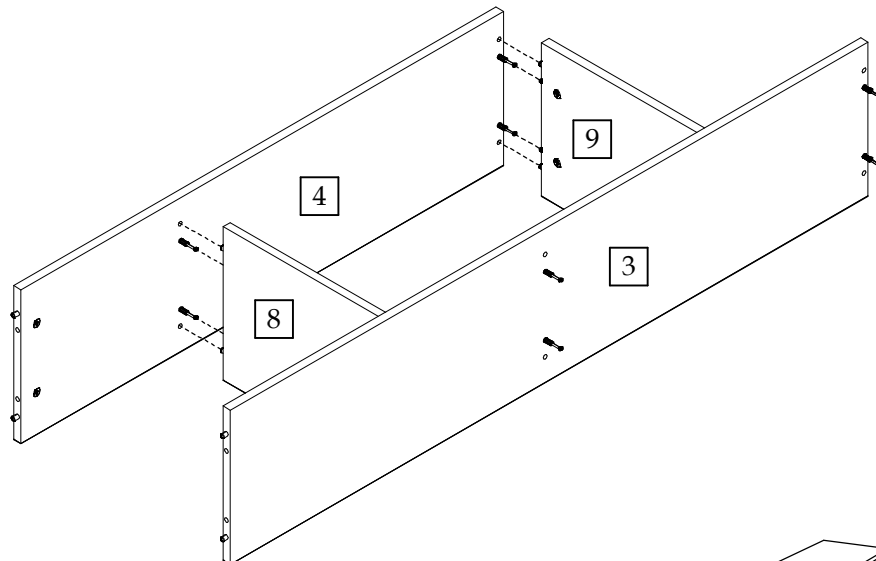

► 5

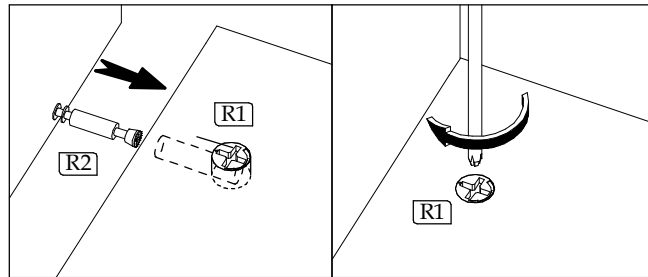
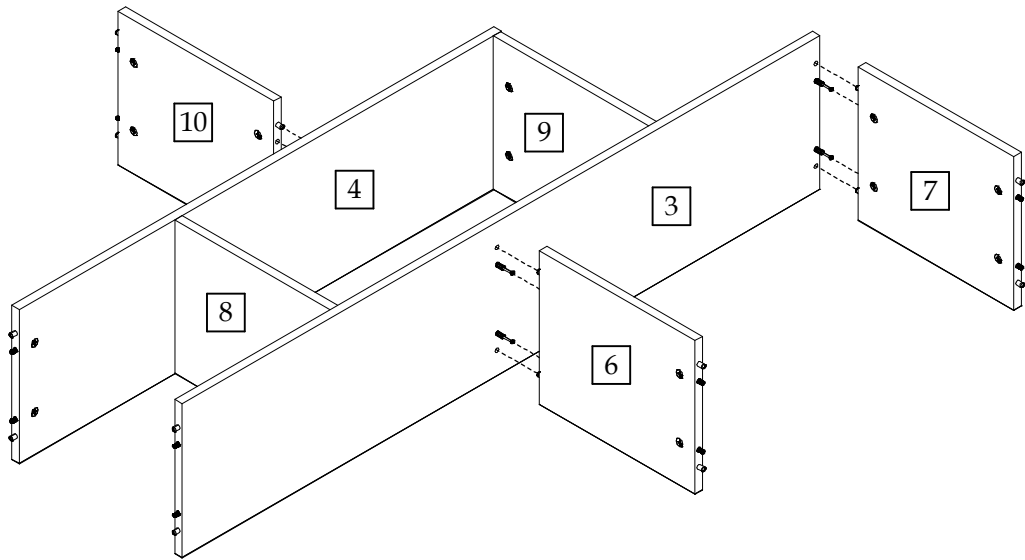

► 6

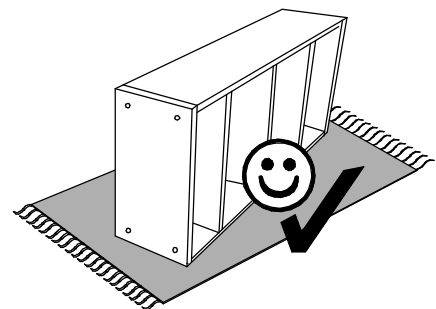
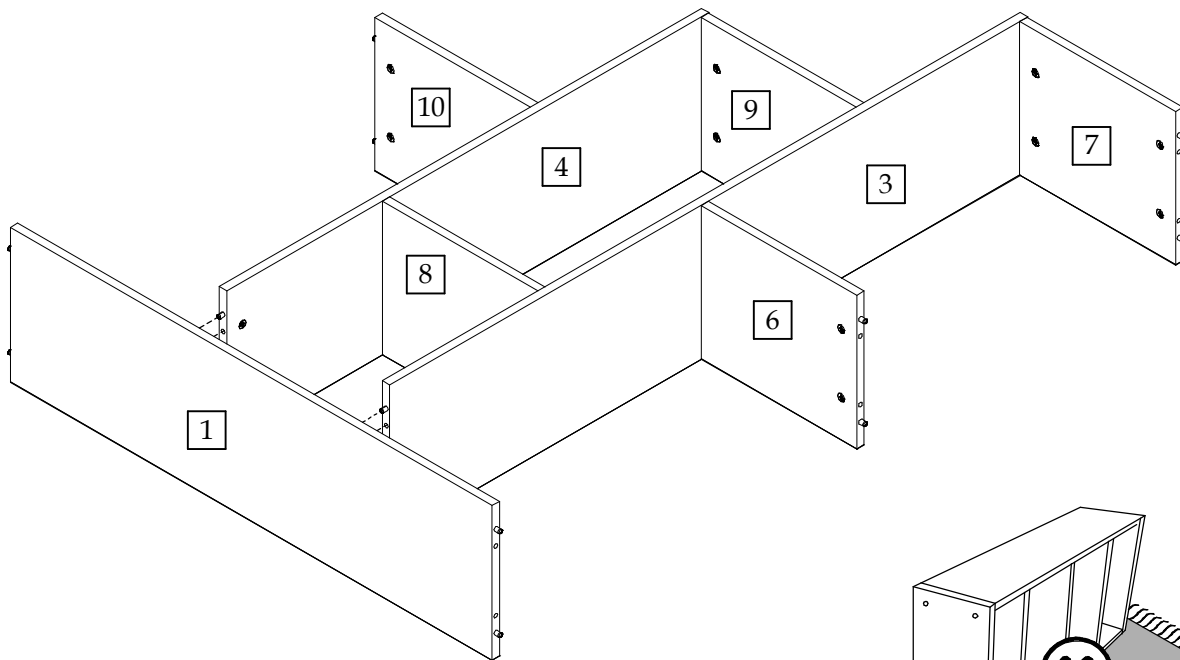

▶ 7

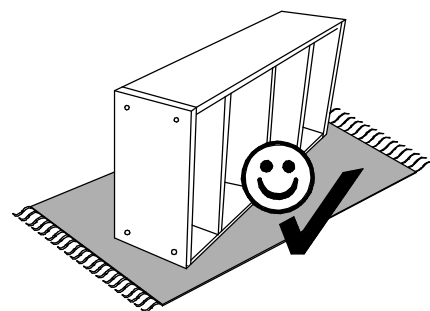
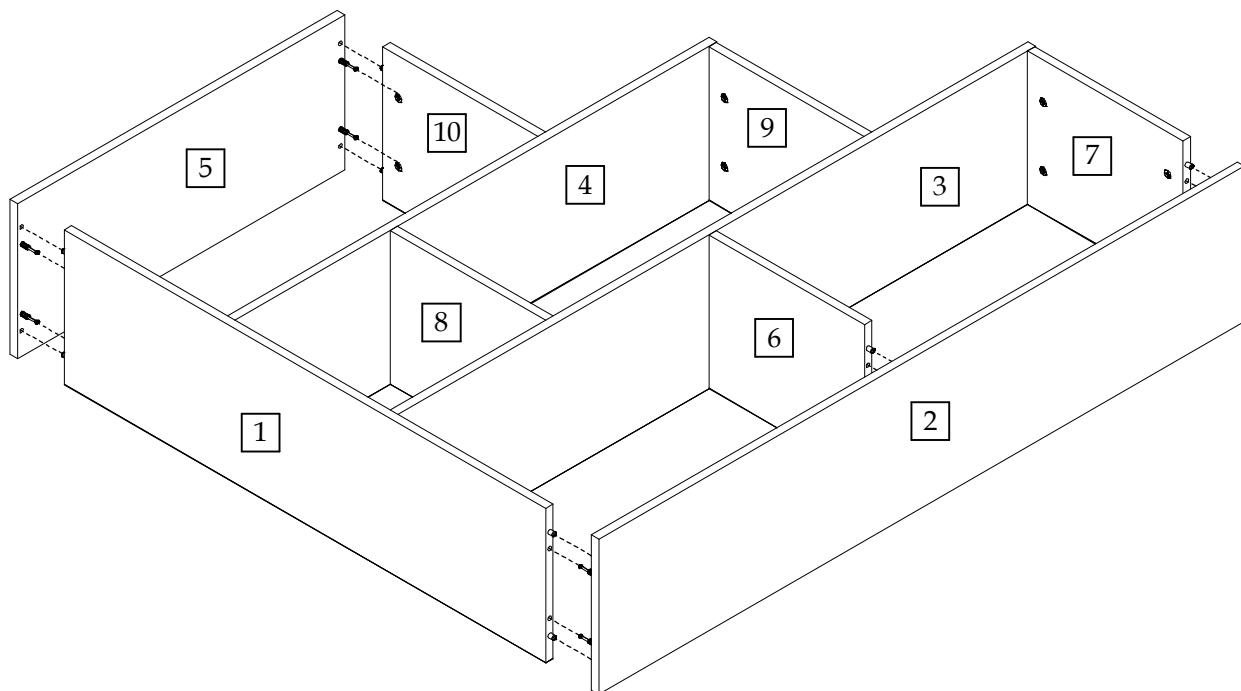
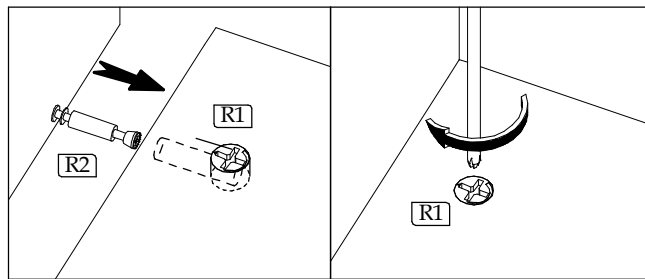

▶ 8

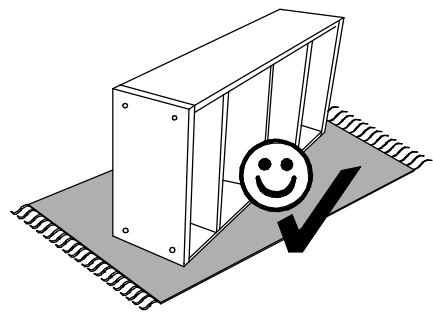
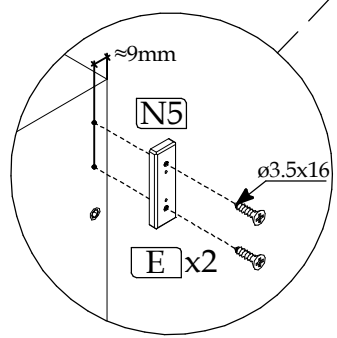
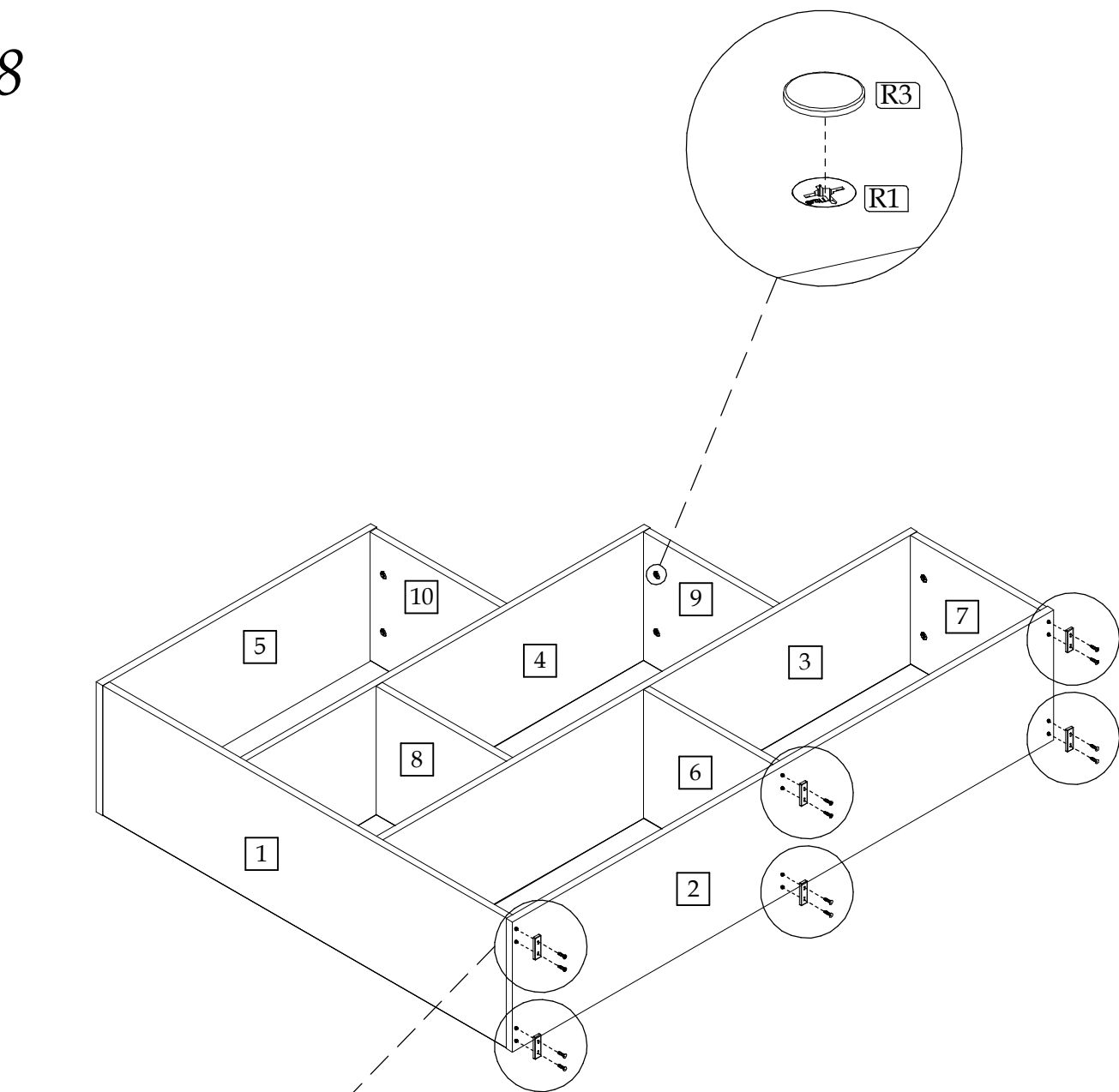

▶ 9

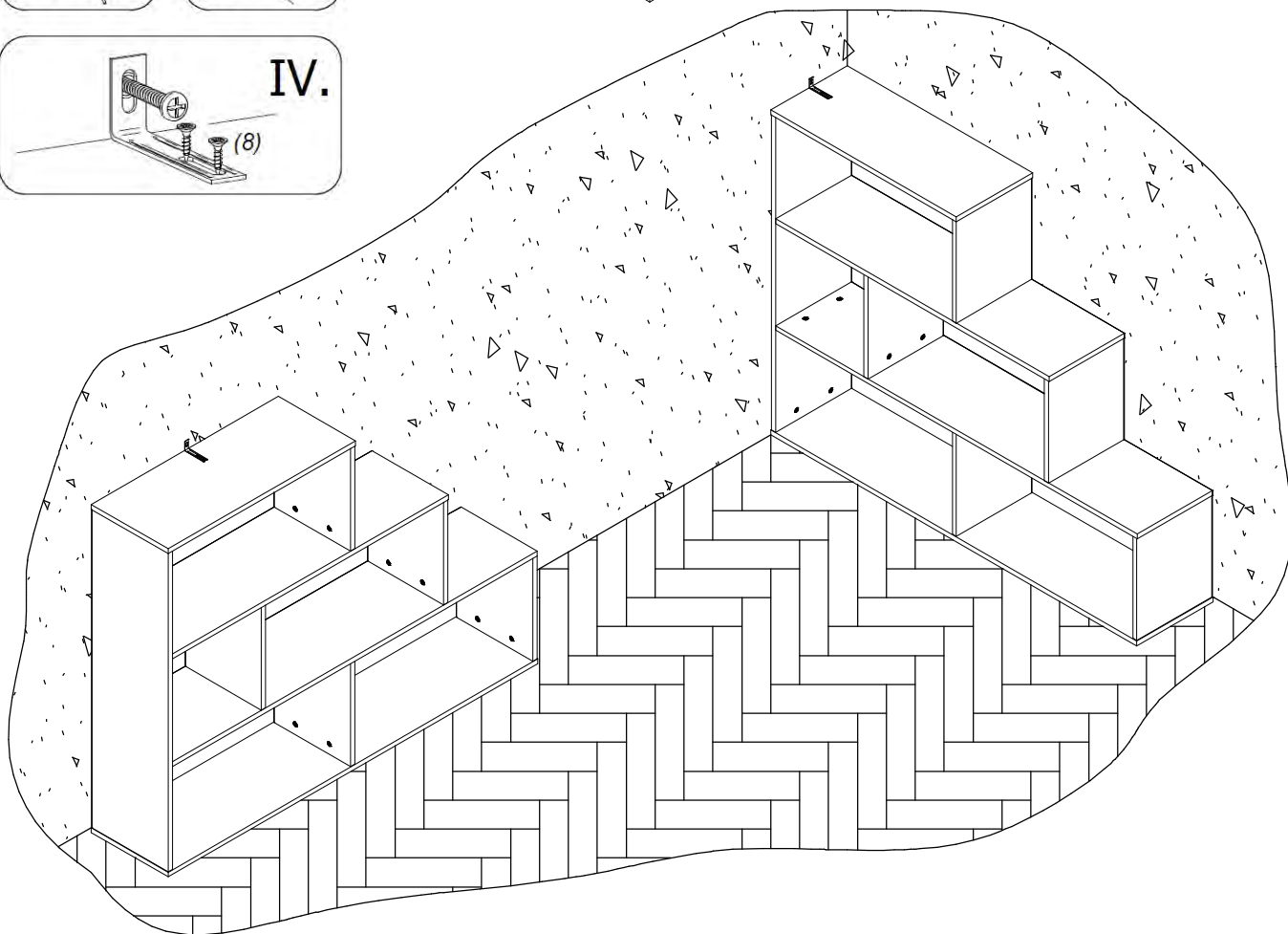
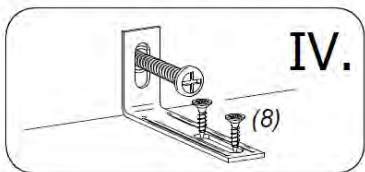
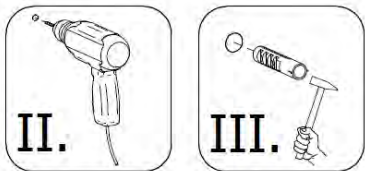
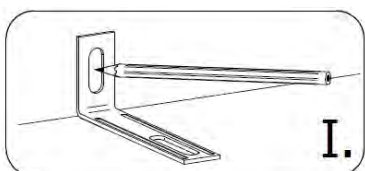
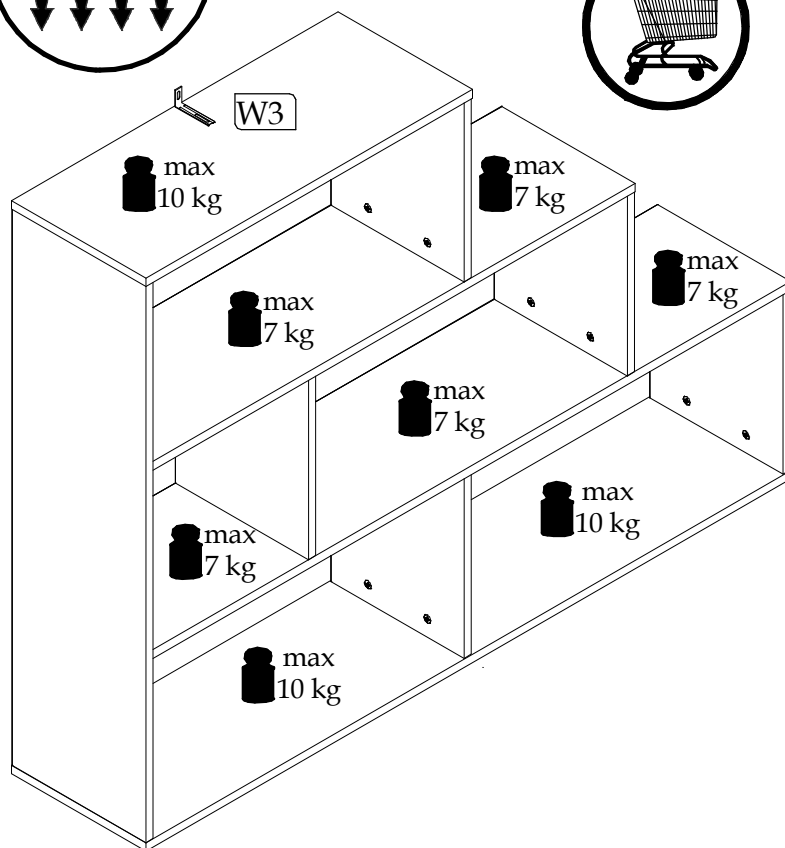
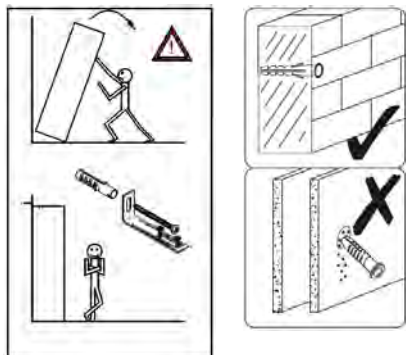
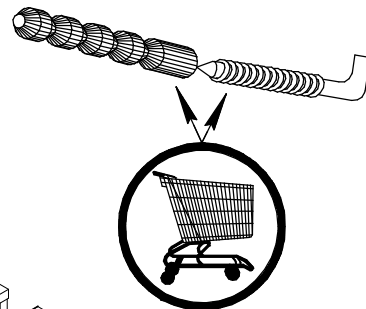

► 10

