

# WEIL K

+

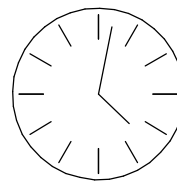

90 min

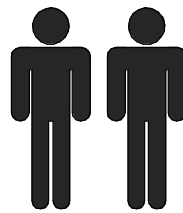
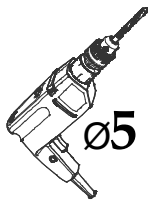
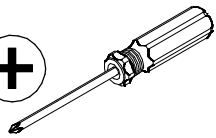
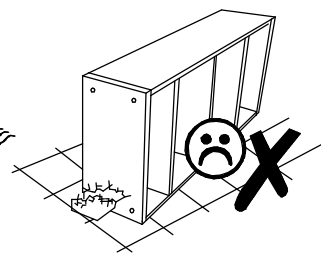
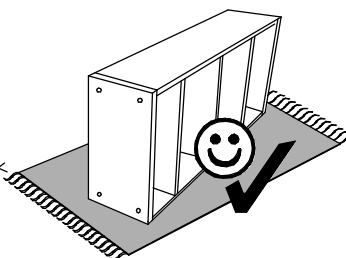
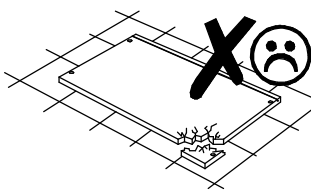
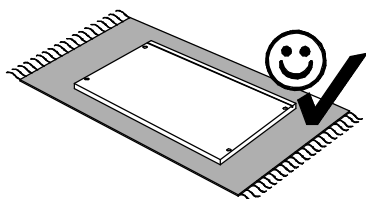
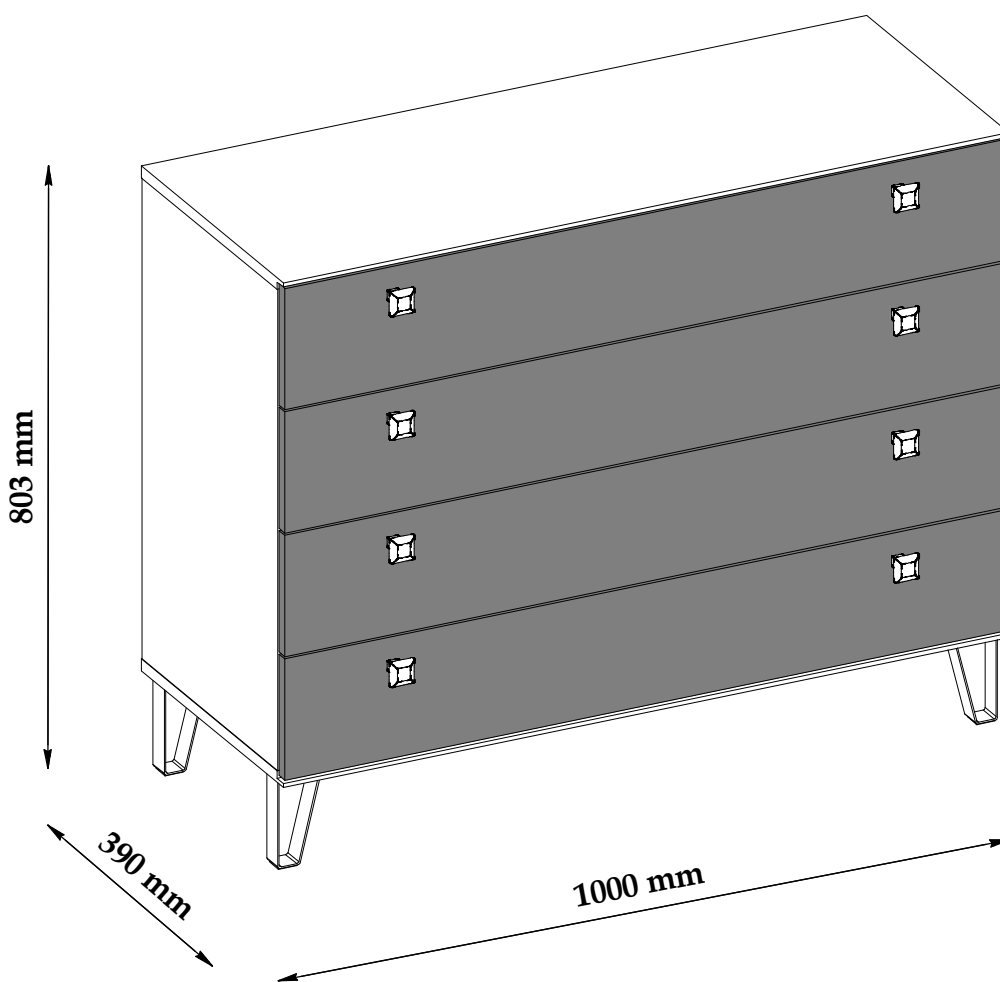

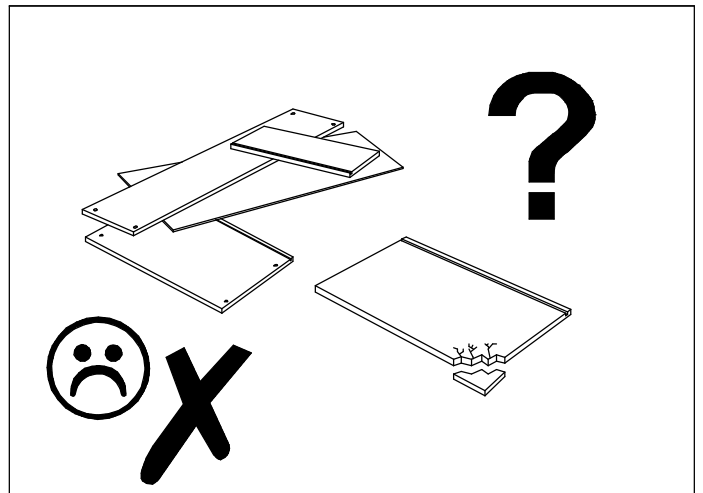
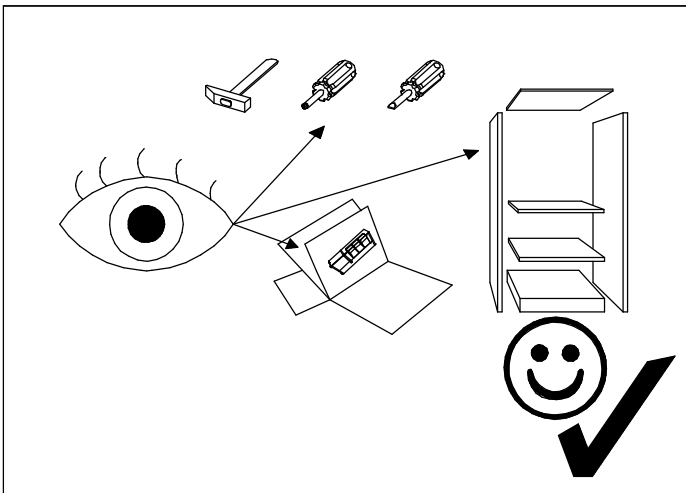
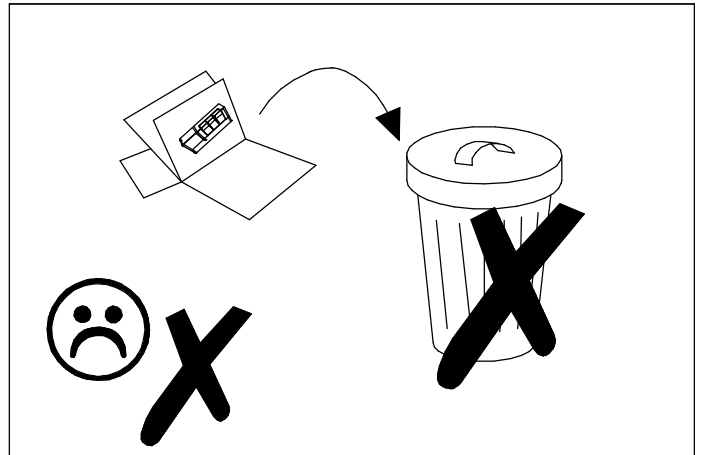
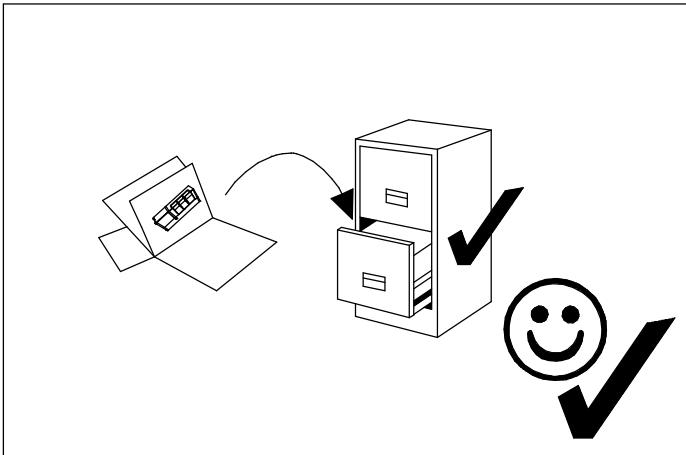
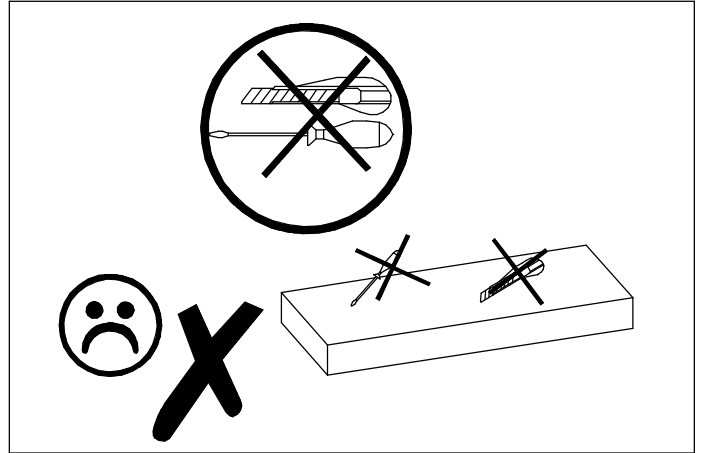
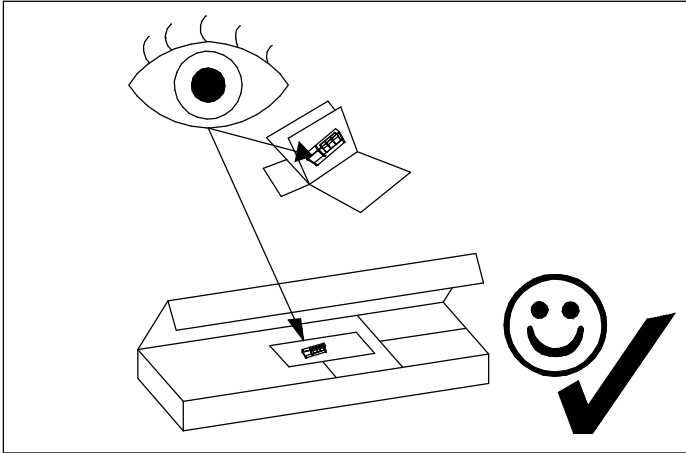

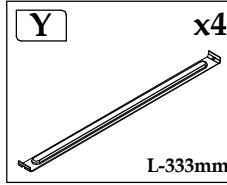
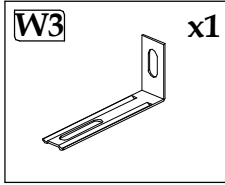
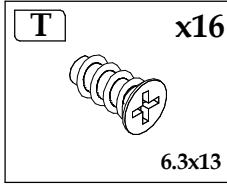
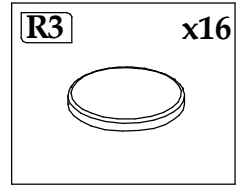
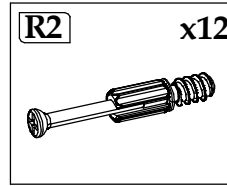
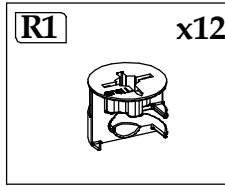
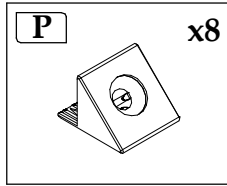
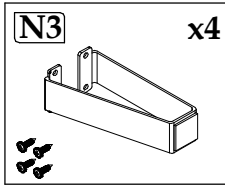
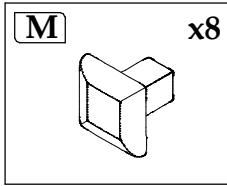
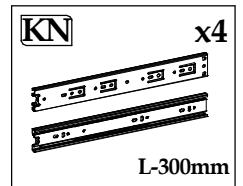
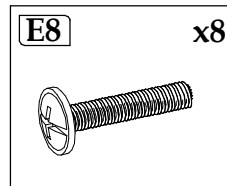
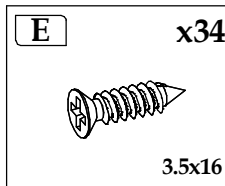
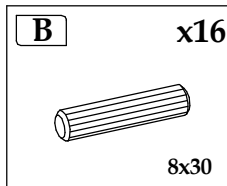
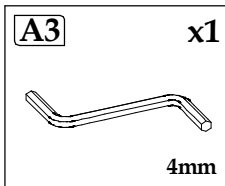
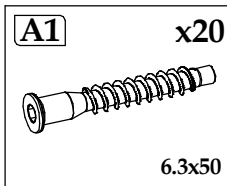

Element symbol	Measurements				Code	Paket
	1	2	3	4		
1	1000	390	16	1	1002	1/ 2
2	1000	390	16	1	1001	1/ 2
3	651	372.5	16	1	1003	1/ 2
4	651	372.5	16	1	1004	1/ 2
5	350	110	16	4	1052	1/ 2
6	908,5	110	16	4	1053	1/ 2
7	350	110	16	4	1054	1/ 2
8	922,5	346	3	4		1/ 2
9	980	334,5	3	2	1006_v	1/ 2
10	997	166	16	4	1019_v	2/ 2

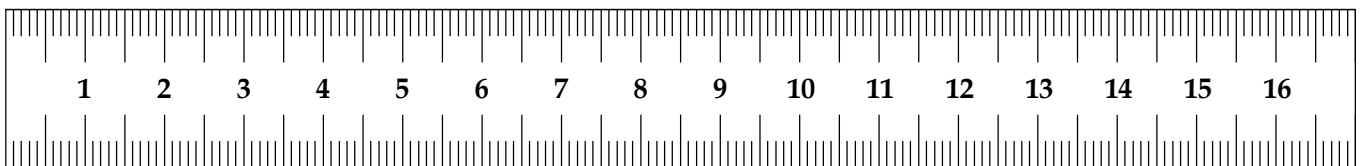
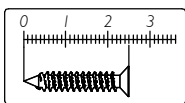
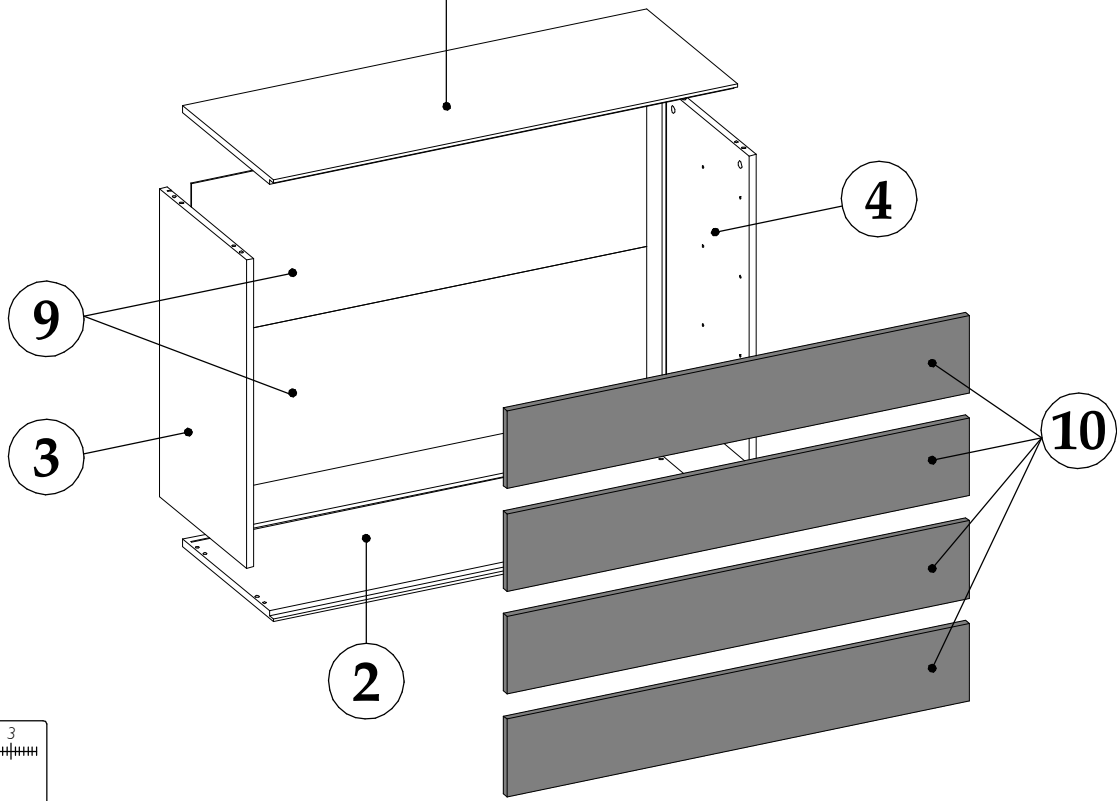
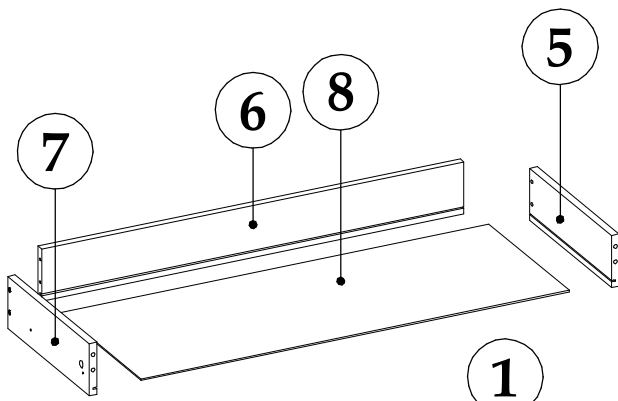

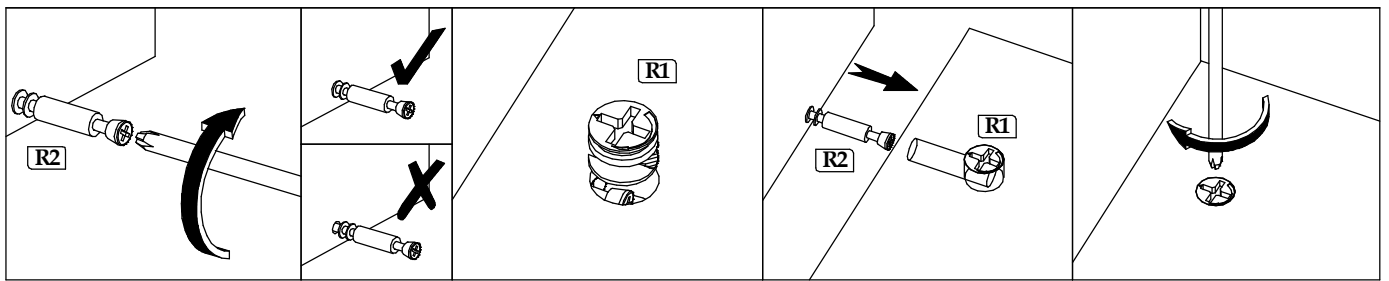

▶ 1

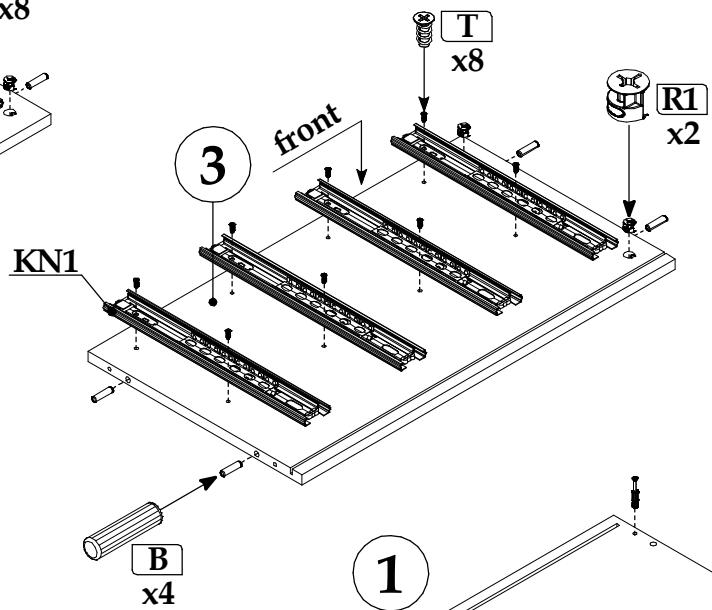
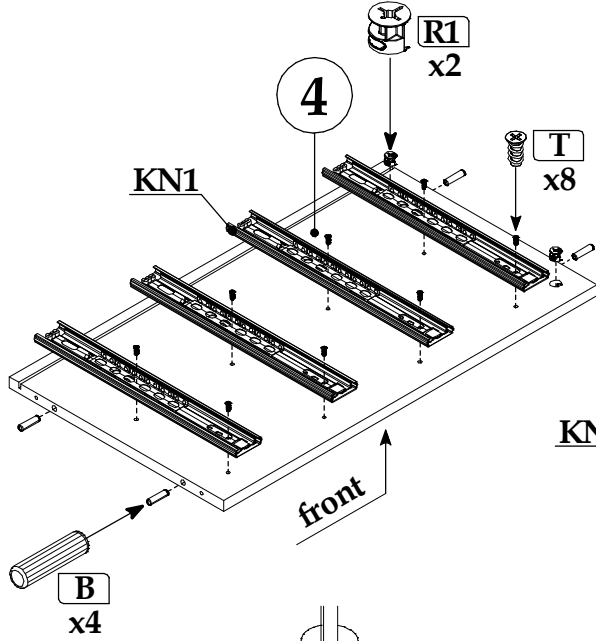
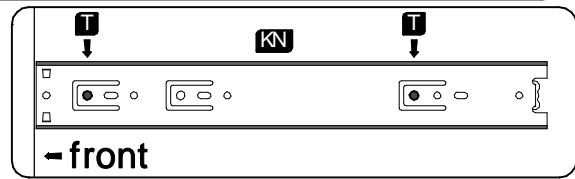
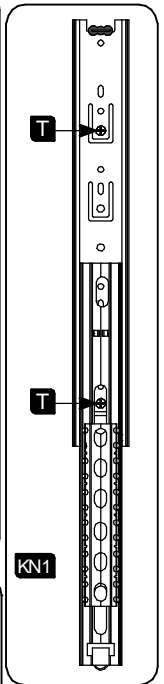
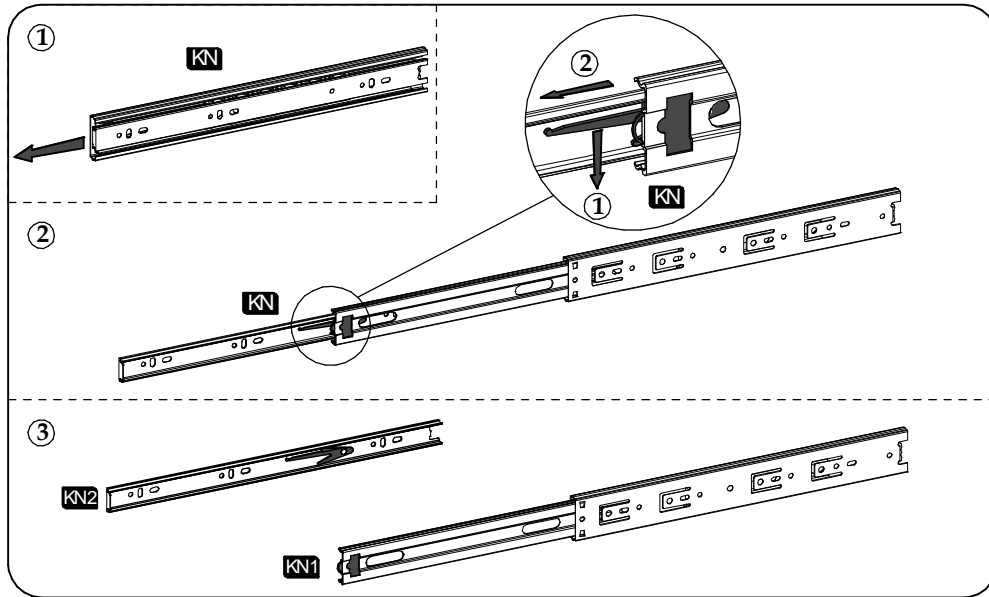
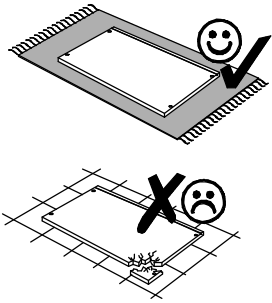

▶ 2

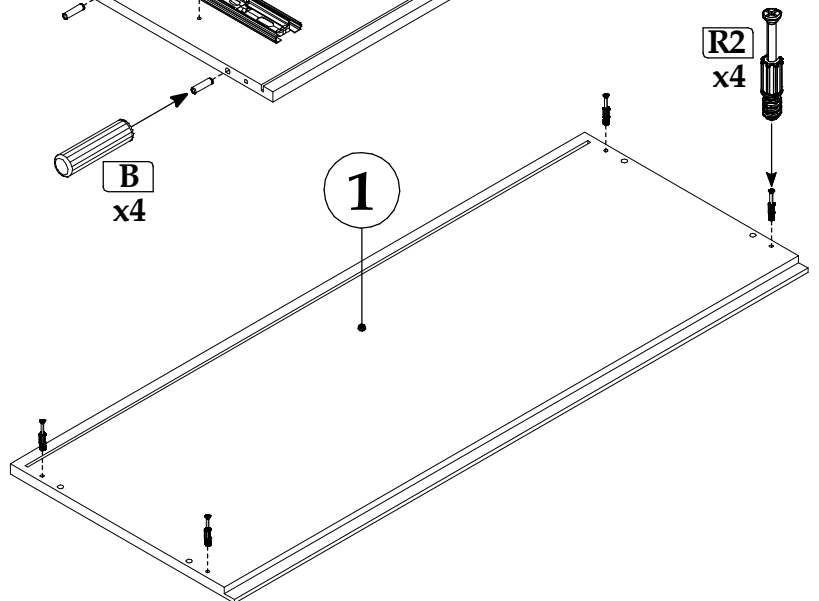
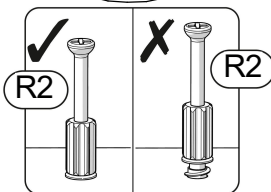
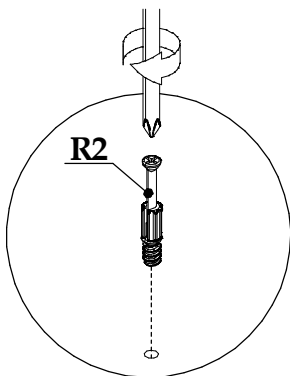

▶ 3

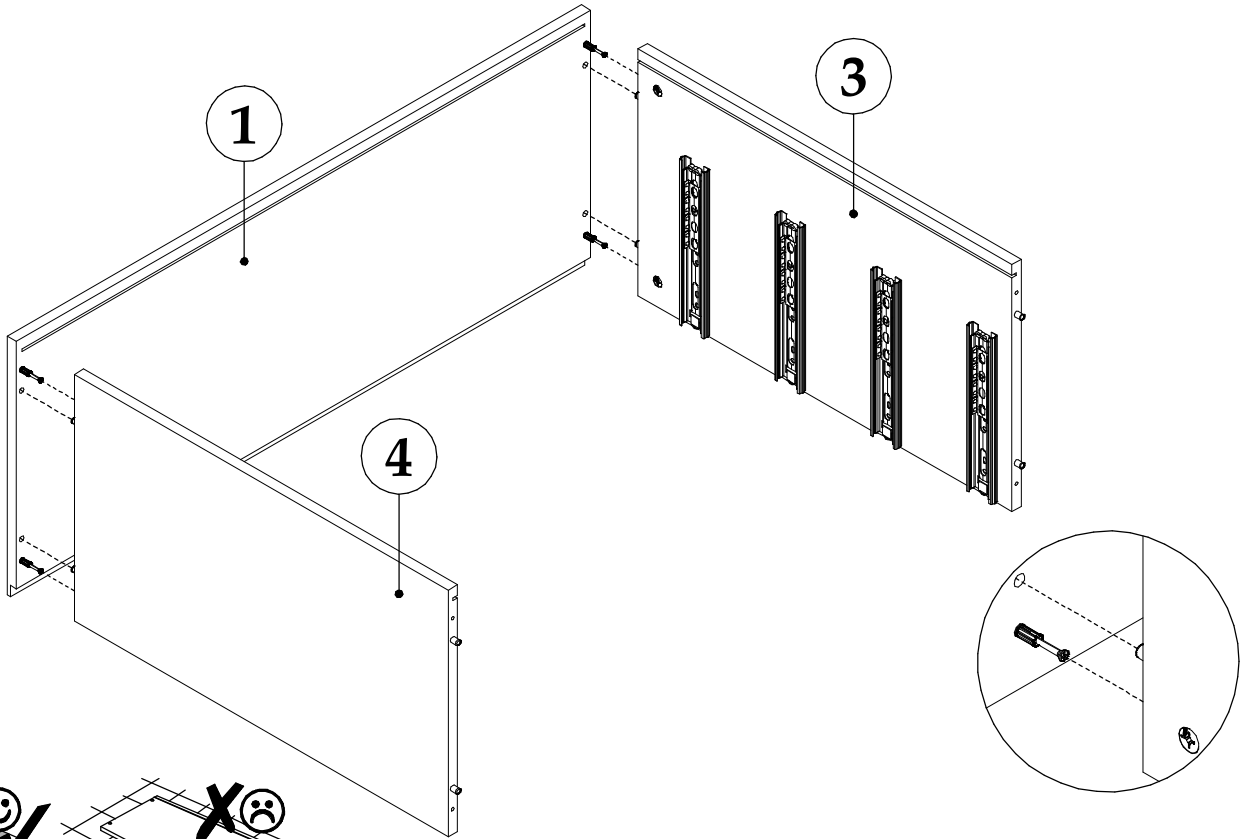

▶ 4

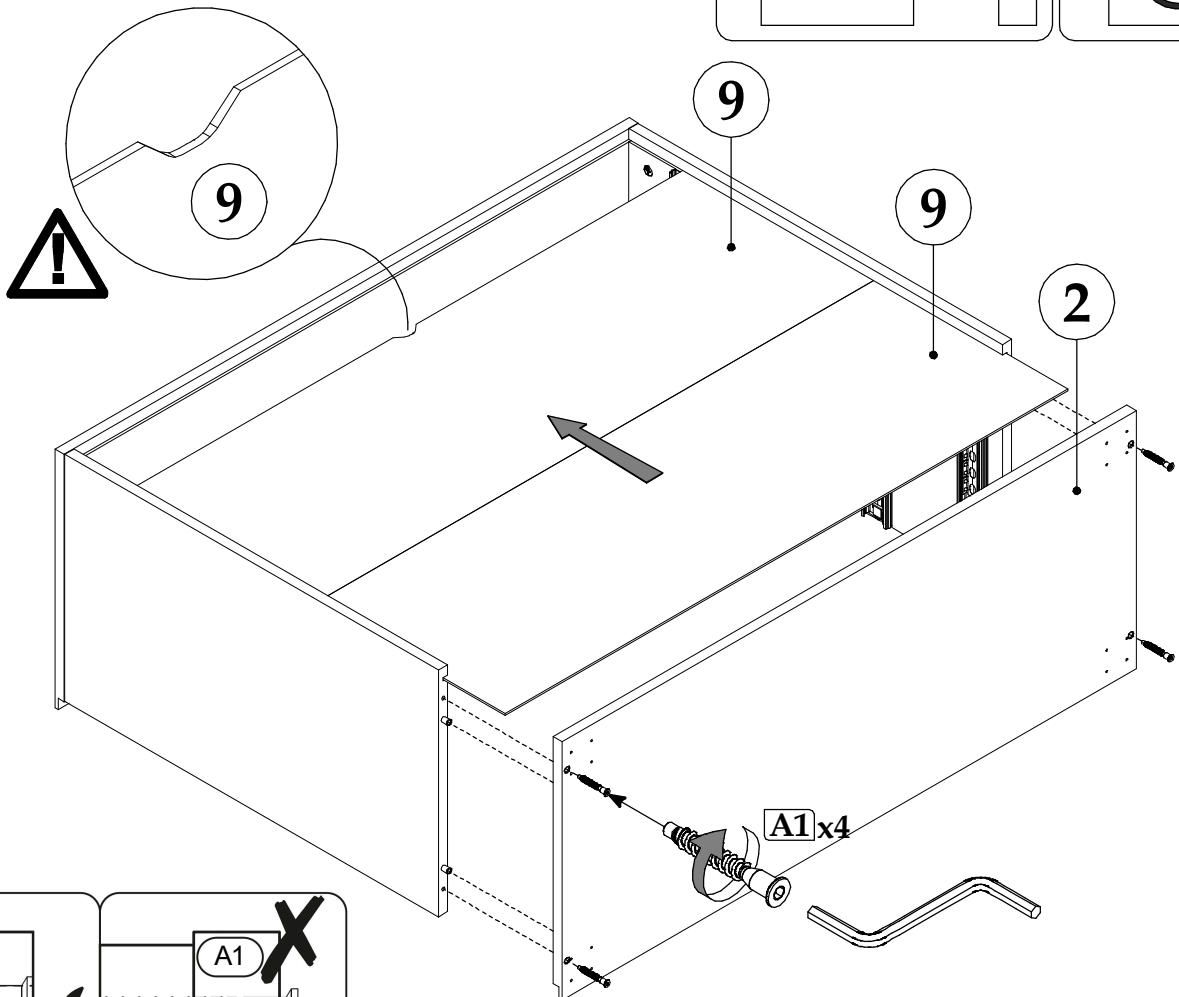

▶ 5

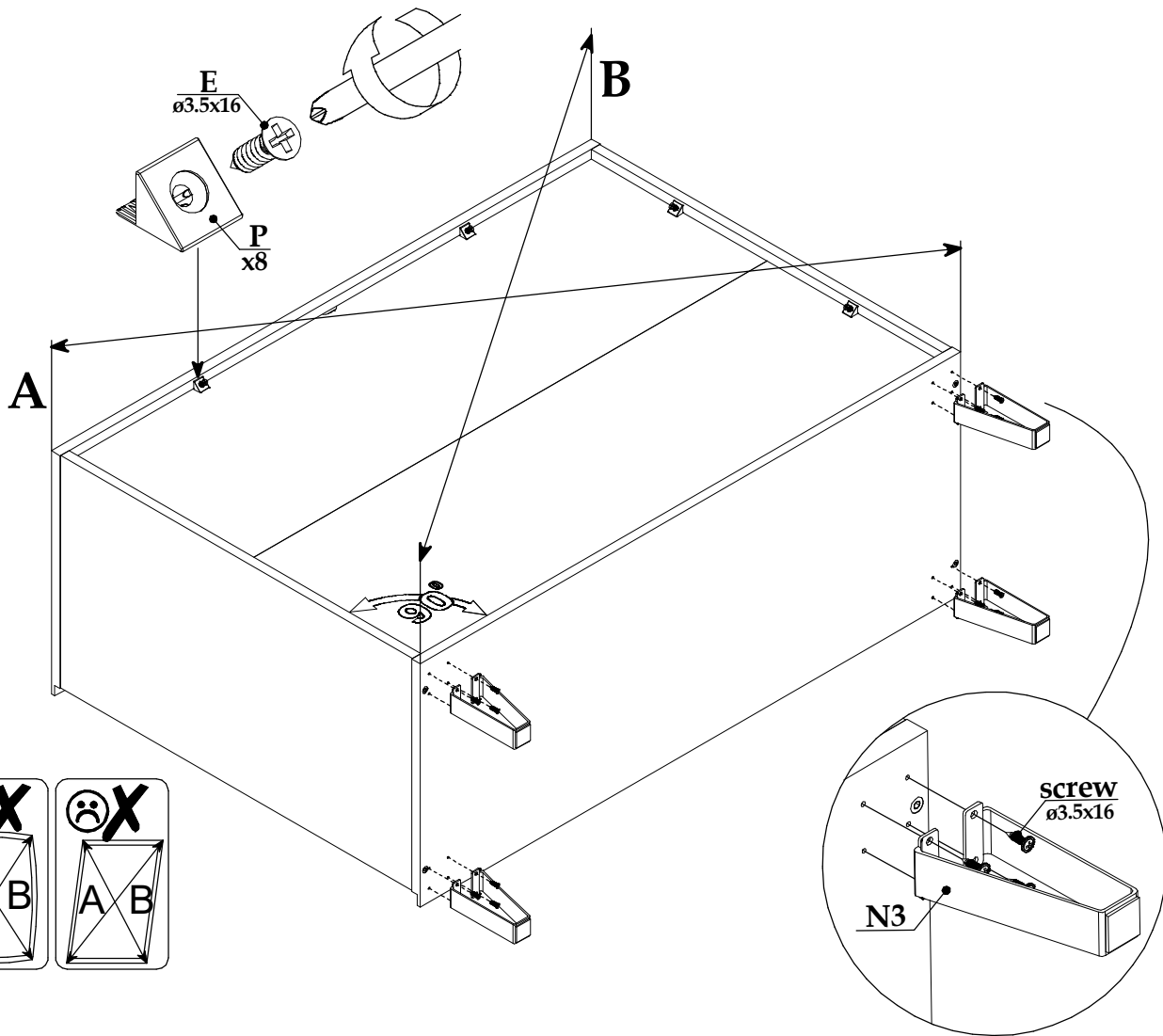

▶ 6

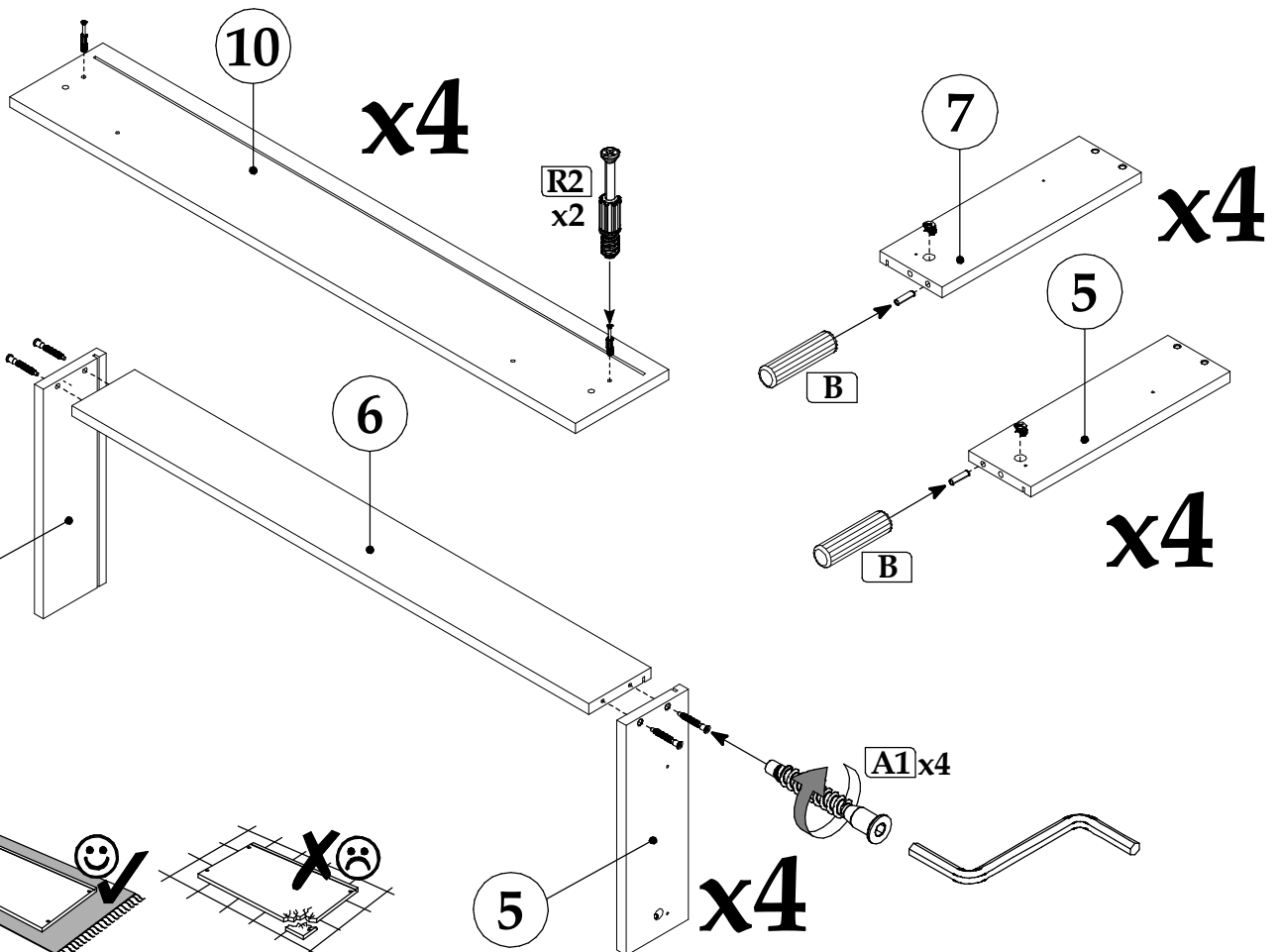

▶ 1

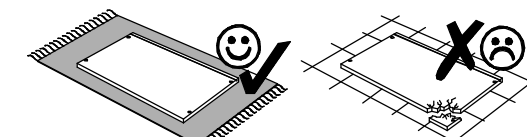

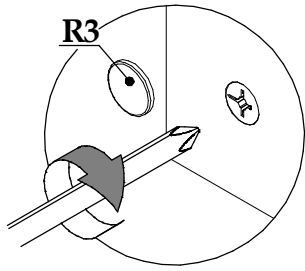

**2**

7

8

10

5

**x4**

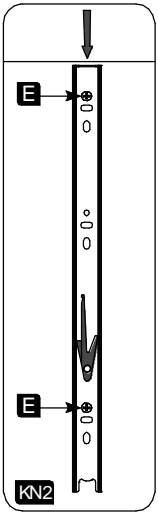

**3**

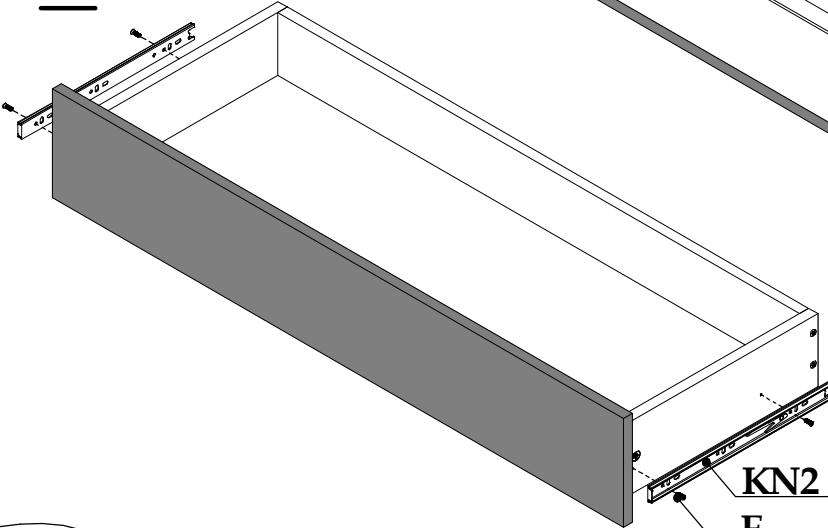

**x4**

KN2  
E  
ø3.5x16

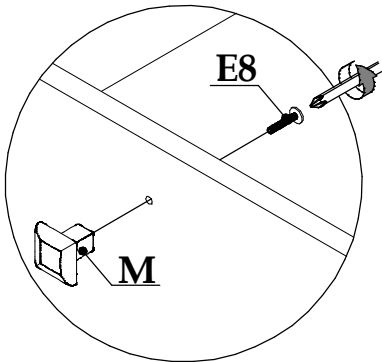

**4**

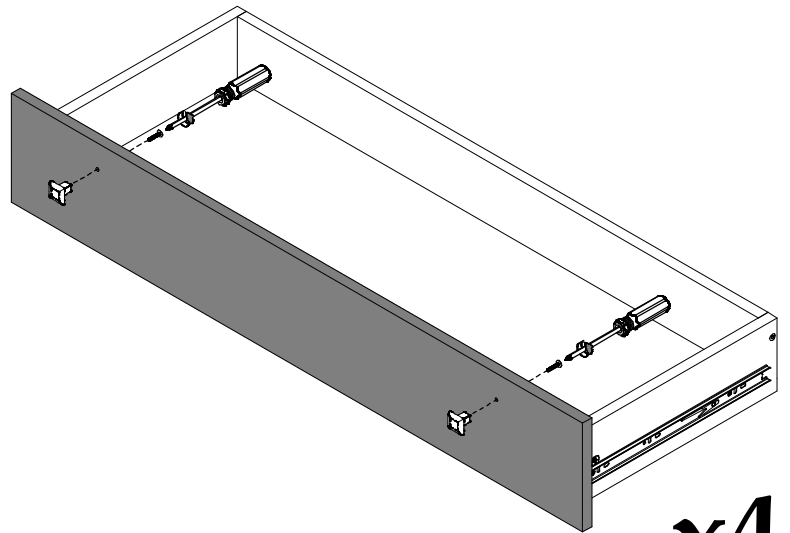

**x4**

**5**

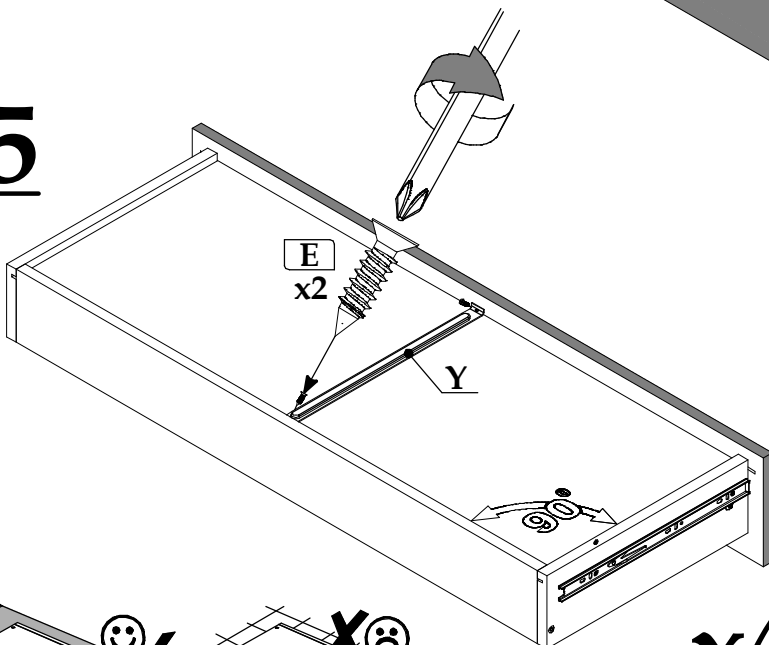

**x4**

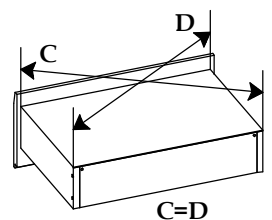

C=D

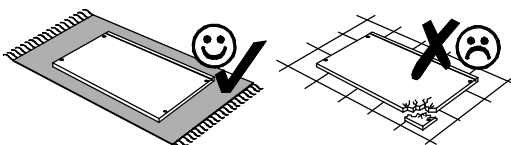

7



max. 5kg

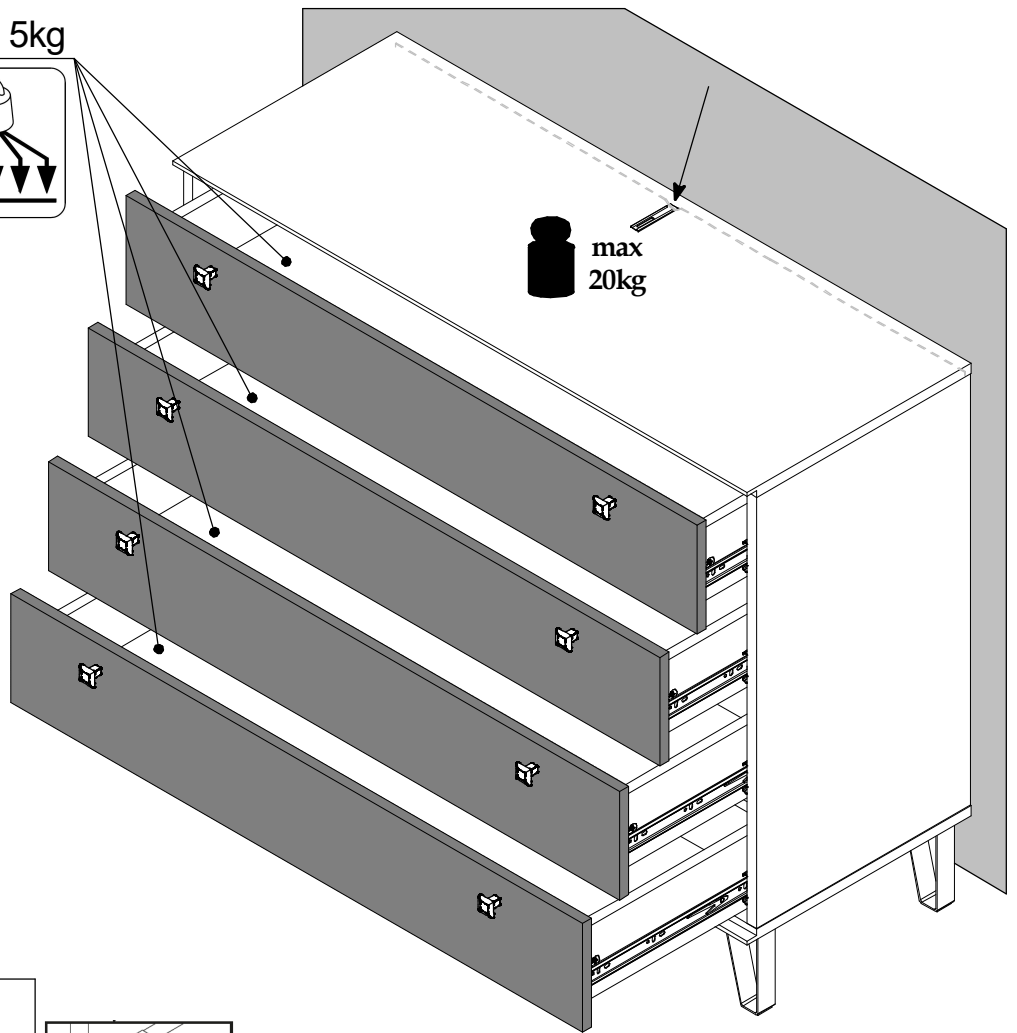
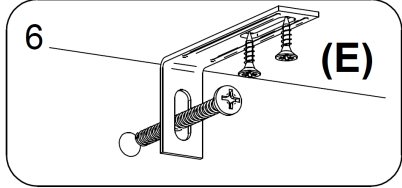
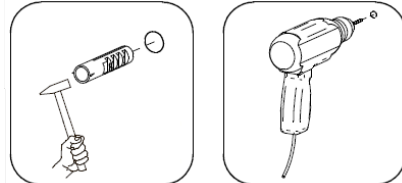
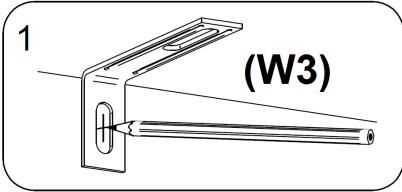
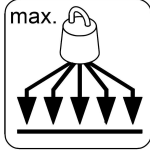

max 20kg

